



#### Features

- Comfort Depth® design offers a 19" (483 mm) step-over height.
- End drain.
- Slotted overflow for deep soaking.
- Integral lumbar support and armrests for comfort.
- Textured bottom surface.
- Coordinates with other products in the Archer® collection.
- 60" (1524 mm) x 32" (813 mm) x 19" (483 mm)

#### Material

- Acrylic

#### Installation

- Drop-in

#### Required Accessories

K- 7271 Brass Slotted Overflow Bath Drain

or

K- 7272 PVC Slotted Overflow Bath Drain



**ADA**

#### Codes/Standards

CSA B45.5/IAPMO Z124

Greenguard UL 2818 - Gold

ADA











ICC/ANSI A117.1

#### KOHLER® One-Year Limited Warranty

See website for detailed warranty information.

#### Available Color/Finishes

*Color tiles intended for reference only.*

Color	Code	Description
	0	White
	96	Biscuit
	47	Almond
	NY	Dune
	95	Ice™ Grey
	G9	Sandbar
	33	Mexican Sand™
	K4	Cashmere
	58	Thunder™ Grey
	7	Black Black™

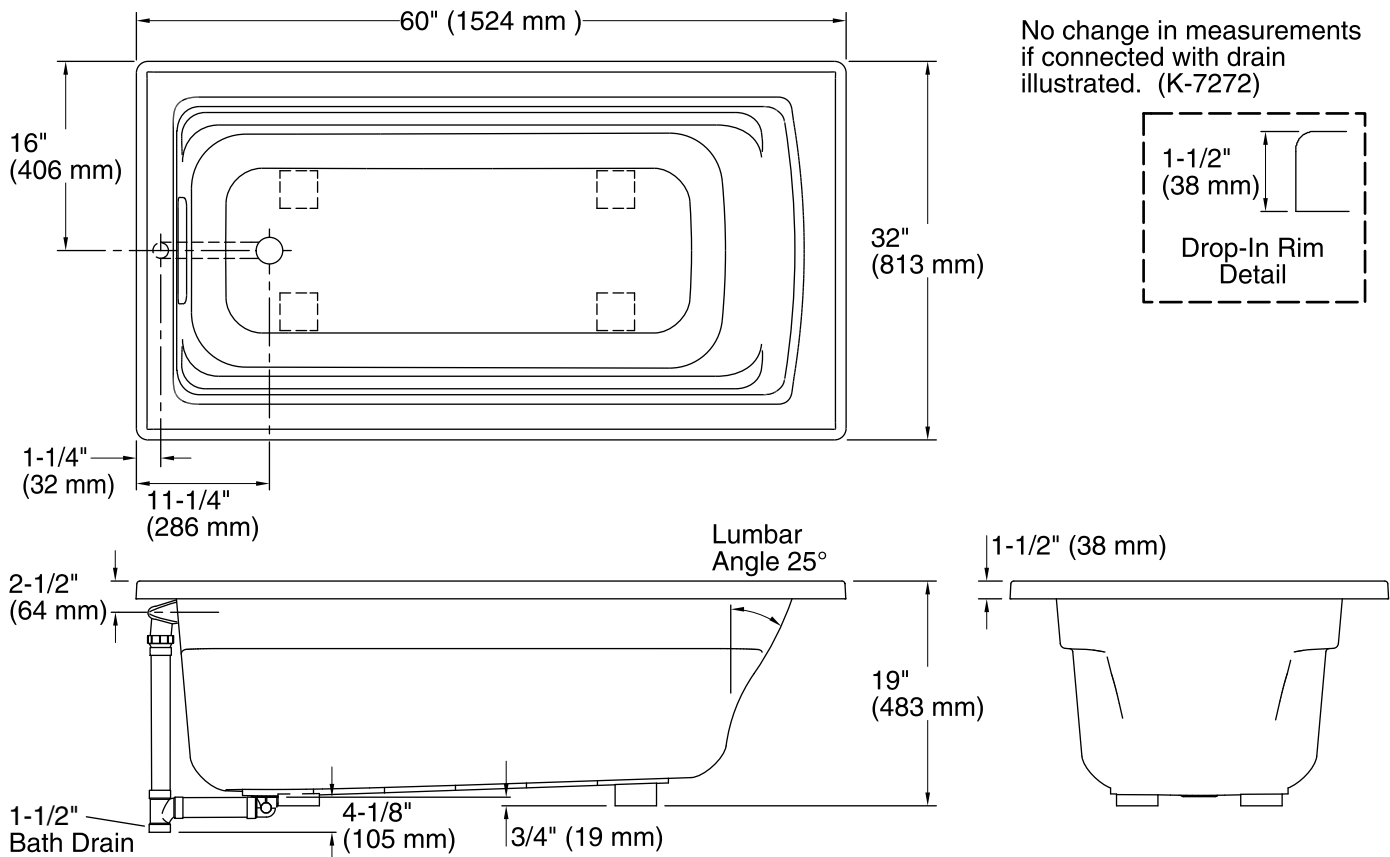

No change in measurements if connected with drain illustrated. (K-7272)

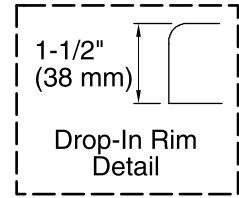

### Technical Information

All product dimensions are nominal.

Installation:	Drop-in
Drain location:	End
Basin area, bottom:	45-1/8" x 19-11/16" (1146 mm x 500 mm)
Basin area, top:	52-3/4" x 25-5/16" (1340 mm x 643 mm)
Weight:	70 lbs (31.8 kg)
Minimum floor load:	44 lbs/ft <sup>2</sup> (214.8 kg/m <sup>2</sup> )
Water depth:	15" (381 mm)
Water capacity:	58 gal (219.6 L)
Cutout:	Drop-in, 58-1/2" x 30-1/2" (1486 mm x 775 mm)
Minimum flat for door:	1-7/16" (36 mm)

### Notes

Measure your actual product for rough-in details.

Install this product according to the installation instructions.

The hot water supply should be 70% of the capacity of the bath or greater. Installations will vary.

ADA compliant when installed to the specific requirements of these regulations.