

Solstice® Inverter Air-to-Water Heat Pump

FEATURES AND BENEFITS

- Supplies Low Temperature Water for Heating & Chilled Water for Cooling
- Reliable Mitsubishi Inverter Compressor
- Low Ambient Cooling Capabilities
- 46-130°F System Water Temperatures (Controls on Return)
- Available in 3 and 5 ton Models
- Domestic Hot Water Offset
- Monobloc Design (No On-Site Refrigerant Charging)
- Keeps all Refrigerant Outside the Occupied Space
- Freeze Protection
- Low Amp Draw with Ultra Quiet Operation
- Modbus Compatible
- User Friendly Advanced Color Touch Screen Control (24ga shielded 5 wire. Can be Remote Mounted up to 600ft)
- Precision Temperature Control Platform
- DC Driven Fan Motors
- Outdoor Coils Have Been Tested in Accordance with GB/T 2432.17 Salt Spray Test
- Eligible for Rebates
- **Industry Leading 10-Year Compressor Warranty & 5-Year Parts Warranty for Certified Contractors**



SPACE PAK®

260 North Elm St., Westfield, MA 01085
(800) 465-8558

7555 Tranmere Drive, Mississauga, ONT. L5S 1L4 Canada
(905) 670-5888

www.spacepak.com

PROJECT: _____ DATE: _____

LOCATION: _____

CUSTOMER: _____

ENGINEER: _____

SUBMITTED BY: _____

FOR: Reference Approval Construction

UNIT DESIGNATION: _____

SCHEDULE NUMBER: _____

SUBMITTAL DATA: Heat Pump SIM

SIM DIMENSIONS (INCHES)

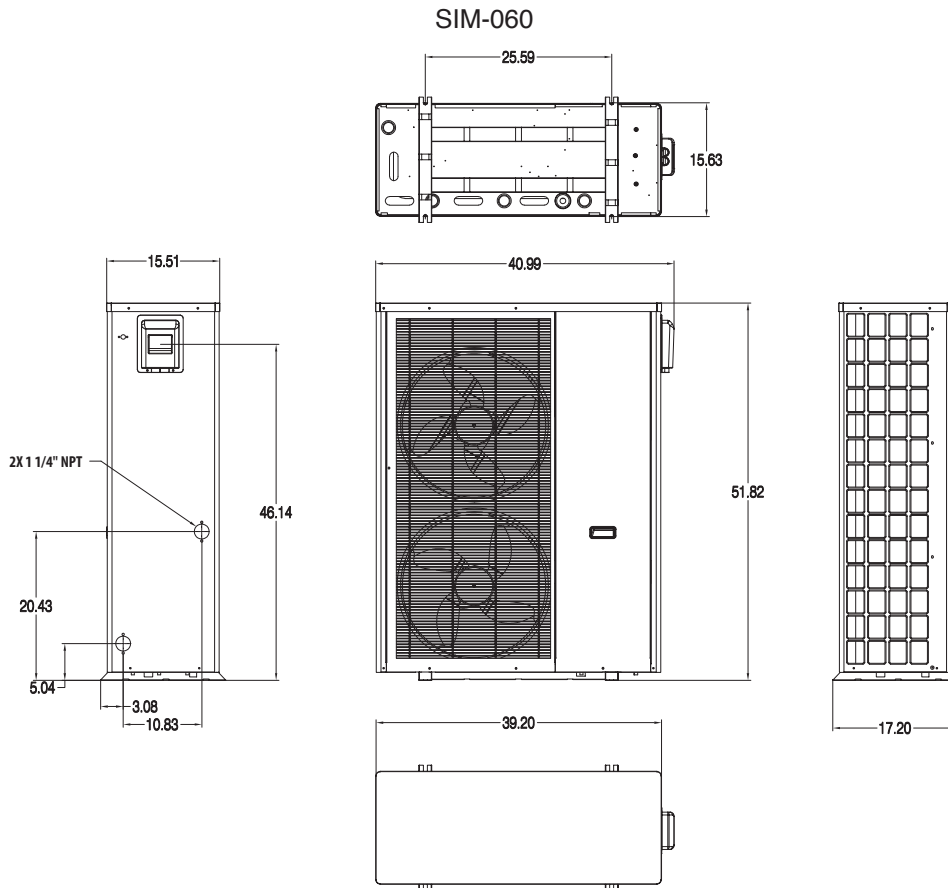
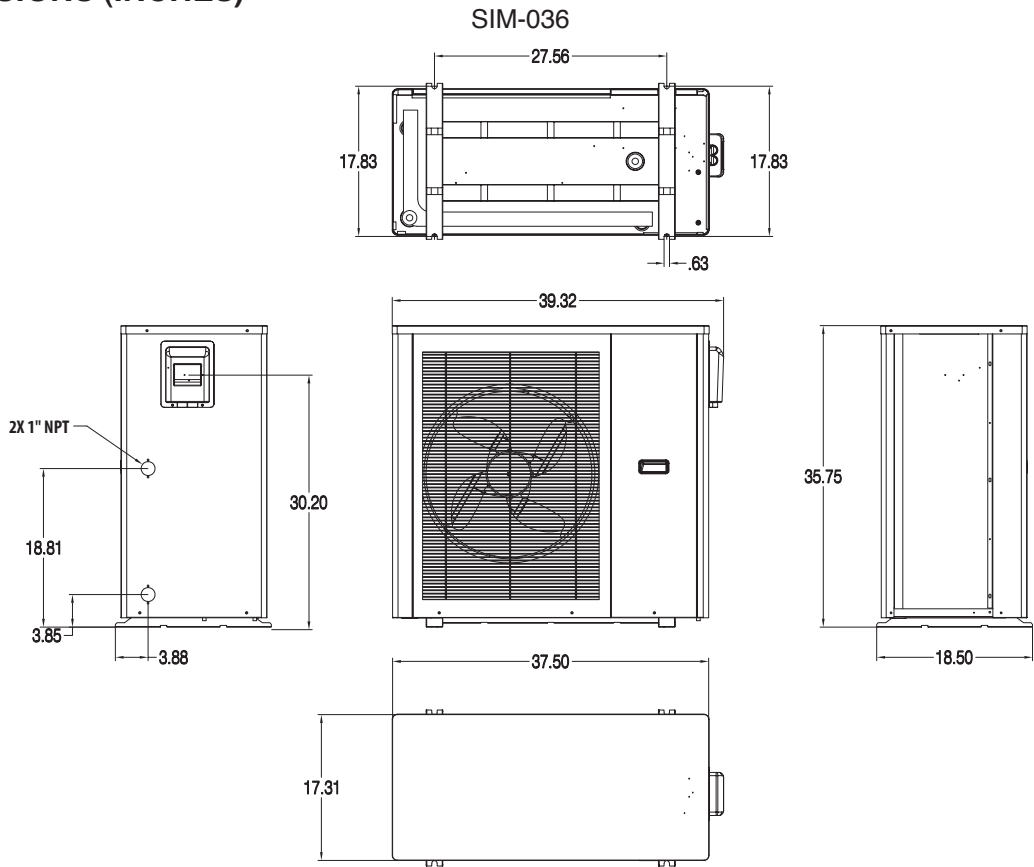

SUBMITTAL DATA: Heat Pump SIM

SIM SPECIFICATIONS

		Units	SIM-036	SIM-060
Cooling	Capacity Range	BTU/hr (kW)	12,704 - 34,423 (4-10)	17,884 - 59,523 (5-17)
	Efficiency Range	EER	11.26-11.74	10.75-11.26
	Efficiency	IPLV	12.2	12.1
	Water Temperature Setpoint (Return)	°F (°C)	46-68 (8-20)	
	Ambient Temp Range	°F (°C)	5-110 (-15-43)	
Heating	Capacity Range	BTU/hr (kW)	13,191 - 38,755 (4-11)	25,413 - 70,666 (7-21)
	Efficiency Range	COP	4.04-5.01	3.69-4.67
	Water Temperature Setpoint (Return)	°F (°C)	86-130 (30-55)	
	Ambient Temp Range	°F (°C)	5-109 (-15-43)	
CEC Data	Cooling Capacity*	BTU/hr (kW)	34,120 (10)	49,490 (15)
	Cooling Efficiency*	EER	10	8.8
	Heating Capacity**	BTU/hr (kW)	39,240 (12)	56,315 (17)
	Heating Efficiency**	COP	3	
	Heating Capacity***	BTU/hr (kW)	21,236 (6)	48,260 (14)
	Heating Efficiency***	COP	1.9	
Electrical	Power	V/Ph/Hz	230/1/60	
	Fan Motor	A	0.8	0.8 (x2)
	Compressor Motor	A	14	25
	MCA	A	24	35
	MOPD	A	30	50
	SCCR	kA	5	
Refrigerant	Type		R410A	
	Factory Charge	lbs. (kg)	5.29 (2.4)	7.06 (3.2)
Fan	Quantity		1	2
	Power Input	W	200	
	Type		EC	
	Max Speed	RPM	750	
Sound (@3 ft/1m)	Maximum	dBA	54	58
	Rated Flow	GPM	7	13
Hydronic	Max Water Temp	°F (°C)	131 (55)	
	Piping Connections	inch (cm)	1 (2.5)	1.25 (3.2)
	Rated Pressure Drop @ Rated Flow	PSI (ft W.C.)	6 (13.8)	10 (23)
	Type		Rotary Inverter	
Compressor	Speed Range	Hz	30-90	
	Brand		Mitsubishi	
	Quantity		1	
	Net Dimensions (W x D x H)	inch (cm)	39 x 18 x 35 (98 x 47 x 90)	39 x 13 x 52 (99 x 33 x 132)
Dimensions	Shipping Dimensions (W x D x H)	inch (cm)	41 x 19 x 36 (104 x 49 x 92)	42 x 18 x 53 (107 x 46 x 135)
	Net Weight	lbs. (kg)	243 (110)	326 (148)
	Shipping Weight	lbs. (kg)	271 (123)	368 (167)

CEC is California Energy Commission. Data is tested in accordance with AHRI 550/590

*= 44°F LWT 54°F EWT @10 GPM & 95°F DB Ambient

**= 120°F LWT 107°F EWT @10 GPM & 47°F DB Ambient

***= 120°F LWT 110°F EWT @10 GPM & 17°F DB Ambient

SUBMITTAL DATA: Heat Pump SIM

PERFORMANCE

SIM-036 HEATING

Ambient Temp.	Compressor Frequency	86°F Return Water Temperature							
		30	40	50	60	70	80	90	
45°F DB, 43°F WB	Heating Capacity	13,191	17,406	21,621	25,833	30,140	34,447	38,755	BTU/hr
	COP	5.01	4.93	4.88	4.84	4.46	4.21	4.04	
36°F DB, 34°F WB	Heating Capacity	11,062	14,836	18,611	22,386	26,086	29,785	33,488	BTU/hr
	COP	4.01	3.87	3.79	3.74	3.64	3.57	3.52	
19°F DB, 18°F WB	Heating Capacity	10,539	12,621	14,700	16,782	19,536	22,294	25,048	BTU/hr
	COP	2.97	2.91	2.88	2.85	2.81	2.78	2.75	
5°F DB, 3°F WB	Heating Capacity	8,256	9,829	11,406	12,980	15,007	17,038	19,065	BTU/hr
	COP	2.18	2.25	2.31	2.35	2.29	2.25	2.22	

Ambient Temp.	Compressor Frequency	104°F Return Water Temperature							
		30	40	50	60	70	80	90	
45°F DB, 43°F WB	Heating Capacity	12,116	16,014	20,086	24,154	28,222	32,294	36,366	BTU/hr
	COP	3.70	3.54	3.47	3.43	3.31	3.22	3.16	
36°F DB, 34°F WB	Heating Capacity	9,215	13,065	16,915	20,765	24,427	28,089	31,751	BTU/hr
	COP	3.20	3.06	2.98	2.94	2.88	2.84	2.81	
19°F DB, 18°F WB	Heating Capacity	7,345	10,200	13,300	15,345	18,219	21,089	23,963	BTU/hr
	COP	2.50	2.37	2.29	2.23	2.18	2.15	2.13	
5°F DB, 3°F WB	Heating Capacity	4,150	6,703	9,256	11,809	14,362	16,915	19,468	BTU/hr
	COP	1.78	1.82	1.84	1.85	1.88	1.91	1.93	

Ambient Temp.	Compressor Frequency	122°F Return Water Temperature							
		30	40	50	60	70	80	90	
45°F DB, 43°F WB	Heating Capacity	18,150	19,256	20,362	21,471	26,004	30,536	-	BTU/hr
	COP	2.80	2.69	2.60	2.52	2.35	2.24	-	
36°F DB, 34°F WB	Heating Capacity	12,058	14,270	16,485	18,696	22,471	27,007	-	BTU/hr
	COP	2.50	2.33	2.21	2.13	2.14	2.20	-	
19°F DB, 18°F WB	Heating Capacity	8,240	11,320	13,481	14,529	17,444	20,362	-	BTU/hr
	COP	1.45	1.57	1.68	1.79	1.79	1.79	-	
5°F DB, 3°F WB	Heating Capacity	3,413	5,782	8,154	10,522	13,345	16,167	-	BTU/hr
	COP	1.13	1.27	1.34	1.38	1.44	1.48	-	

SIM-036 COOLING

Ambient Temp.	Compressor Frequency	45°F Return Water Temperature							
		30	40	50	60	70	80	90	
86°F DB	Cooling Capacity	8,128	10,757	16,904	20,285	23,768	26,603	30,837	BTU/hr
	EER	9.90	10.14	10.24	10.00	9.62	9.42	9.22	
95°F DB	Cooling Capacity	8,025	10,689	16,836	20,217	23,666	27,149	30,735	BTU/hr
	EER	9.42	9.80	10.07	9.73	9.39	9.18	9.04	
104°F DB	Cooling Capacity	7,991	10,655	16,768	20,114	23,564	27,115	30,394	BTU/hr
	EER	9.18	9.52	9.93	9.56	9.28	9.04	8.81	
113°F DB	Cooling Capacity	7,957	10,587	16,665	20,046	23,495	27,047	-	BTU/hr
	EER	8.94	9.28	9.69	9.42	9.18	8.87	-	

Ambient Temp.	Compressor Frequency	59°F Return Water Temperature							
		30	40	50	60	70	80	90	
86°F DB	Cooling Capacity	12,704	16,631	21,002	24,486	28,413	31,350	34,423	BTU/hr
	EER	11.74	12.32	12.97	12.56	11.67	11.40	11.26	
95°F DB	Cooling Capacity	12,465	16,563	20,661	24,281	28,242	31,520	34,594	BTU/hr
	EER	11.23	11.98	12.42	11.84	11.06	10.89	10.65	
104°F DB	Cooling Capacity	12,157	16,085	20,251	23,359	27,935	30,394	34,082	BTU/hr
	EER	10.31	10.72	11.64	10.85	9.83	9.66	9.42	
113°F DB	Cooling Capacity	11,440	15,538	19,636	22,368	25,613	-	-	BTU/hr
	EER	9.39	10.03	10.44	9.80	8.77	-	-	

SUBMITTAL DATA: Heat Pump SIM

SIM-036 HEATING PERFORMANCE (all data based on pure water)

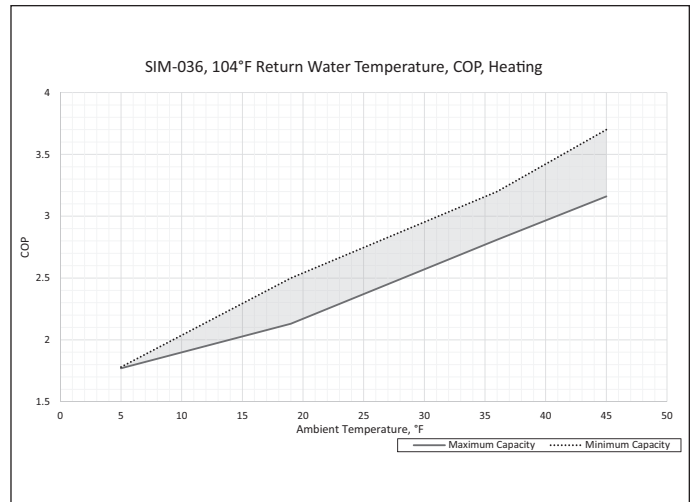
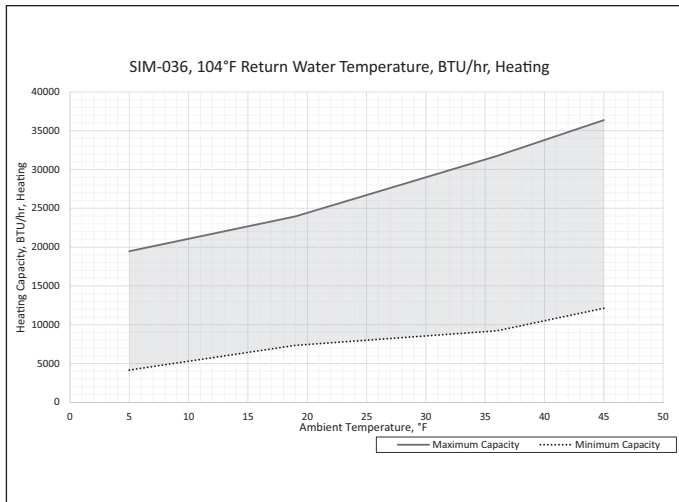
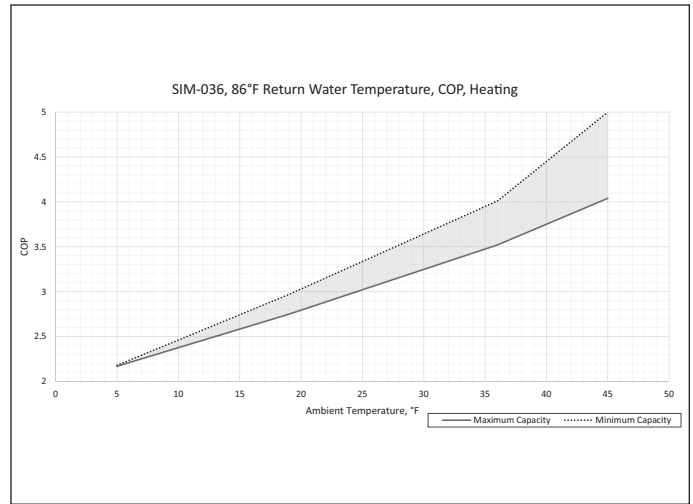
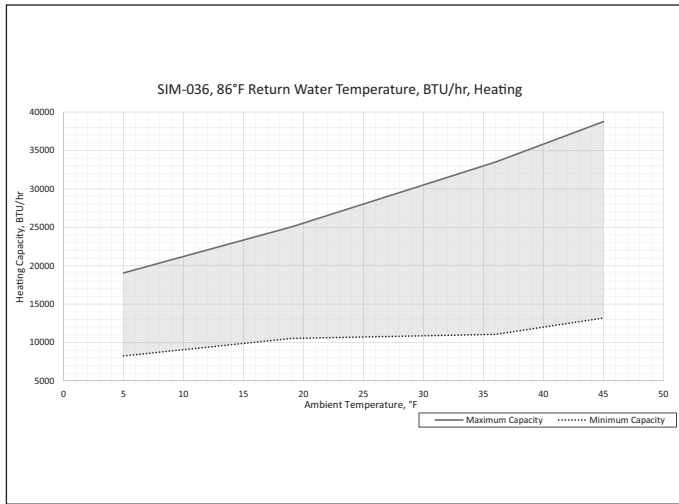

For more performance data, please scan QR code

SUBMITTAL DATA: Heat Pump SIM

PERFORMANCE

SIM-060 HEATING

Ambient Temp.		Compressor Frequency	86°F Return Water Temperature							
			30	40	50	60	70	80	90	
45°F DB, 43°F WB	Heating Capacity		25,413	33,560	41,703	49,847	56,789	63,728	70,666	BTU/hr
	COP		4.67	4.58	4.53	4.49	4.12	3.87	3.69	
36°F DB, 34°F WB	Heating Capacity		18,928	26,847	34,765	42,680	47,895	53,110	58,321	BTU/hr
	COP		3.95	3.80	3.72	3.67	3.32	3.08	2.91	
19°F DB, 18°F WB	Heating Capacity		15,309	21,275	27,239	32,348	37,912	43,475	49,099	BTU/hr
	COP		3.10	2.96	2.87	2.80	2.65	2.55	2.47	
5°F DB, 3°F WB	Heating Capacity		11,690	15,703	19,713	23,727	28,557	33,389	38,219	BTU/hr
	COP		2.08	2.08	2.07	2.07	2.05	2.01	1.96	

Ambient Temp.		Compressor Frequency	104°F Return Water Temperature							
			30	40	50	60	70	80	90	
45°F DB, 43°F WB	Heating Capacity		21,973	30,116	38,263	46,407	52,830	59,250	65,673	BTU/hr
	COP		3.65	3.53	3.47	3.43	3.24	3.11	3.01	
36°F DB, 34°F WB	Heating Capacity		17,748	25,666	33,584	41,502	46,898	52,297	57,693	BTU/hr
	COP		2.95	3.01	3.05	3.07	2.88	2.74	2.64	
19°F DB, 18°F WB	Heating Capacity		14,891	20,799	26,707	32,144	37,222	44,161	47,376	BTU/hr
	COP		2.50	2.40	2.33	2.28	2.18	2.21	2.06	
5°F DB, 3°F WB	Heating Capacity		12,034	15,932	19,830	23,731	26,727	29,724	32,720	BTU/hr
	COP		2.00	1.87	1.80	1.75	1.64	1.56	1.50	

Ambient Temp.		Compressor Frequency	122°F Return Water Temperature							
			30	40	50	60	70	80	90	
45°F DB, 43°F WB	Heating Capacity		18,150	26,294	34,441	42,584	48,004	53,427	-	BTU/hr
	COP		2.80	2.67	2.61	2.57	2.50	2.45	-	
36°F DB, 34°F WB	Heating Capacity		12,058	19,748	27,437	35,130	45,045	50,465	-	BTU/hr
	COP		2.50	2.28	2.20	2.15	2.17	2.20	-	
19°F DB, 18°F WB	Heating Capacity		9,782	15,519	21,256	24,389	28,017	31,642	35,270	BTU/hr
	COP		1.45	1.47	1.48	1.49	1.55	1.59	1.63	
5°F DB, 3°F WB	Heating Capacity		7,505	11,290	15,075	18,860	22,942	27,021	31,099	BTU/hr
	COP		1.13	1.13	1.13	1.13	1.19	1.24	1.28	

SIM-060 COOLING

Ambient Temp.		Compressor Frequency	45°F Return Water Temperature							
			30	40	50	60	70	80	90	
86°F DB	Cooling Capacity		14,915	26,724	32,389	34,915	41,366	45,973	49,591	BTU/hr
	EER		9.83	9.93	10.07	10.04	9.78	9.39	9.04	
95°F DB	Cooling Capacity		14,847	26,621	32,321	34,813	41,297	45,905	49,489	BTU/hr
	EER		9.28	9.69	9.90	9.94	9.52	8.98	8.84	
104°F DB	Cooling Capacity		14,744	26,485	32,185	34,642	41,161	45,734	49,318	BTU/hr
	EER		9.04	9.49	9.73	9.39	9.04	8.77	8.63	
113°F DB	Cooling Capacity		14,676	26,280	32,082	34,574	40,990	45,598	-	BTU/hr
	EER		8.57	9.15	9.49	8.98	8.84	8.23	-	

Ambient Temp.		Compressor Frequency	59°F Return Water Temperature							
			30	40	50	60	70	80	90	
86°F DB	Cooling Capacity		17,884	31,741	38,874	41,912	49,625	55,154	59,523	BTU/hr
	EER		11.26	11.54	11.60	11.47	11.33	11.16	10.75	
95°F DB	Cooling Capacity		17,816	31,946	38,772	41,297	49,557	55,086	58,021	BTU/hr
	EER		10.89	11.26	11.30	11.19	10.75	10.34	10.07	
104°F DB	Cooling Capacity		17,679	31,775	38,635	41,570	49,386	54,881	57,338	BTU/hr
	EER		10.00	10.12	10.35	10.30	9.97	9.73	9.52	
113°F DB	Cooling Capacity		17,611	28,123	37,202	41,502	49,181	54,710	-	BTU/hr
	EER		8.91	9.39	9.73	9.39	9.15	8.87	-	

SUBMITTAL DATA: Heat Pump SIM

SIM-060 HEATING PERFORMANCE (all data based on pure water)

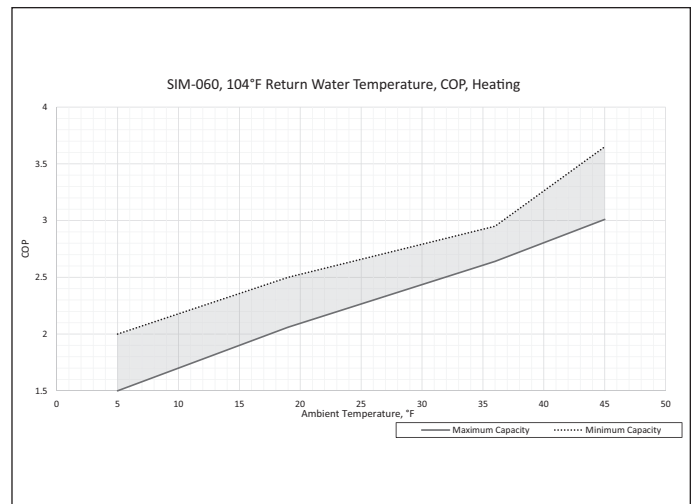
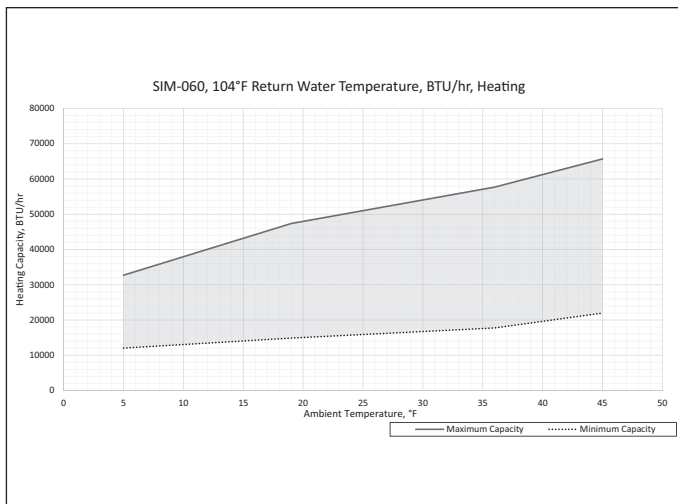
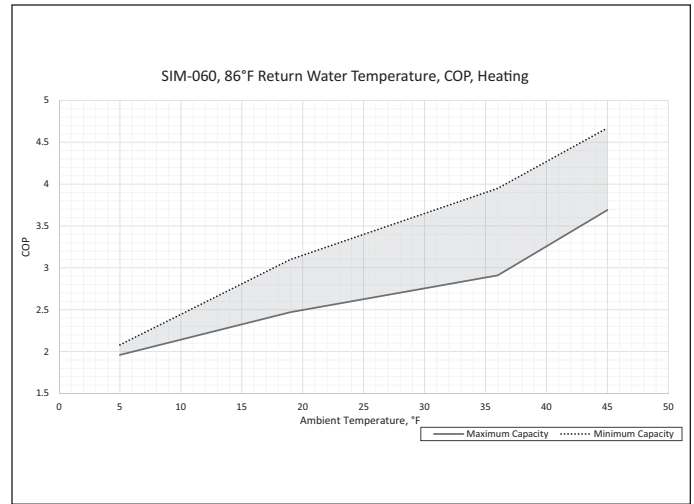
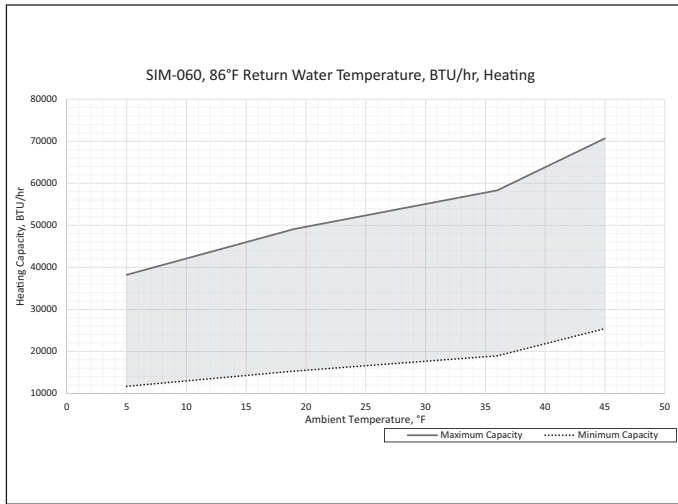

For more performance data, please scan QR code