



Features

- Comfort Depth® design offers a 19" (483 mm) step-over height.
- End drain.
- Slotted overflow for deep soaking.
- Integral lumbar support and armrests for comfort.
- Bask® heated surface creates spa-like relaxation with soothing warmth on your back, shoulders, and neck.
- Textured bottom surface.
- Coordinates with other products in the Archer® collection.
- 72" (1829 mm) x 36" (914 mm) x 19" (483 mm)

Material

- Acrylic

Installation

- Drop-in

Required Accessories

- K-7271 Brass Slotted Overflow Bath Drain
or
• K-7272 PVC Slotted Overflow Bath Drain

Recommended Accessories

- K-1491 Bath/Whirlpool Pillow
- K-1601 Bath/Whirlpool Footstop
- K-9529 Removable Bath Seat
- K-24916 Wireless Music Kit



ADA

Codes/Standards









CSA B45.5/IAPMO Z124
ASTM E162
ASTM E662
UL 1795
CSA C22.2 No. 218.2
Greenguard UL 2818 - Gold
ADA
ICC/ANSI A117.1
CARB P2

KOHLER® One-Year Limited Warranty

See website for detailed warranty information.

Available Color/Finishes

Color tiles intended for reference only.

Color	Code	Description
	0	White
	96	Biscuit
	47	Almond
	NY	Dune
	95	Ice™ Grey
	G9	Sandbar
	K4	Cashmere
	58	Thunder™ Grey

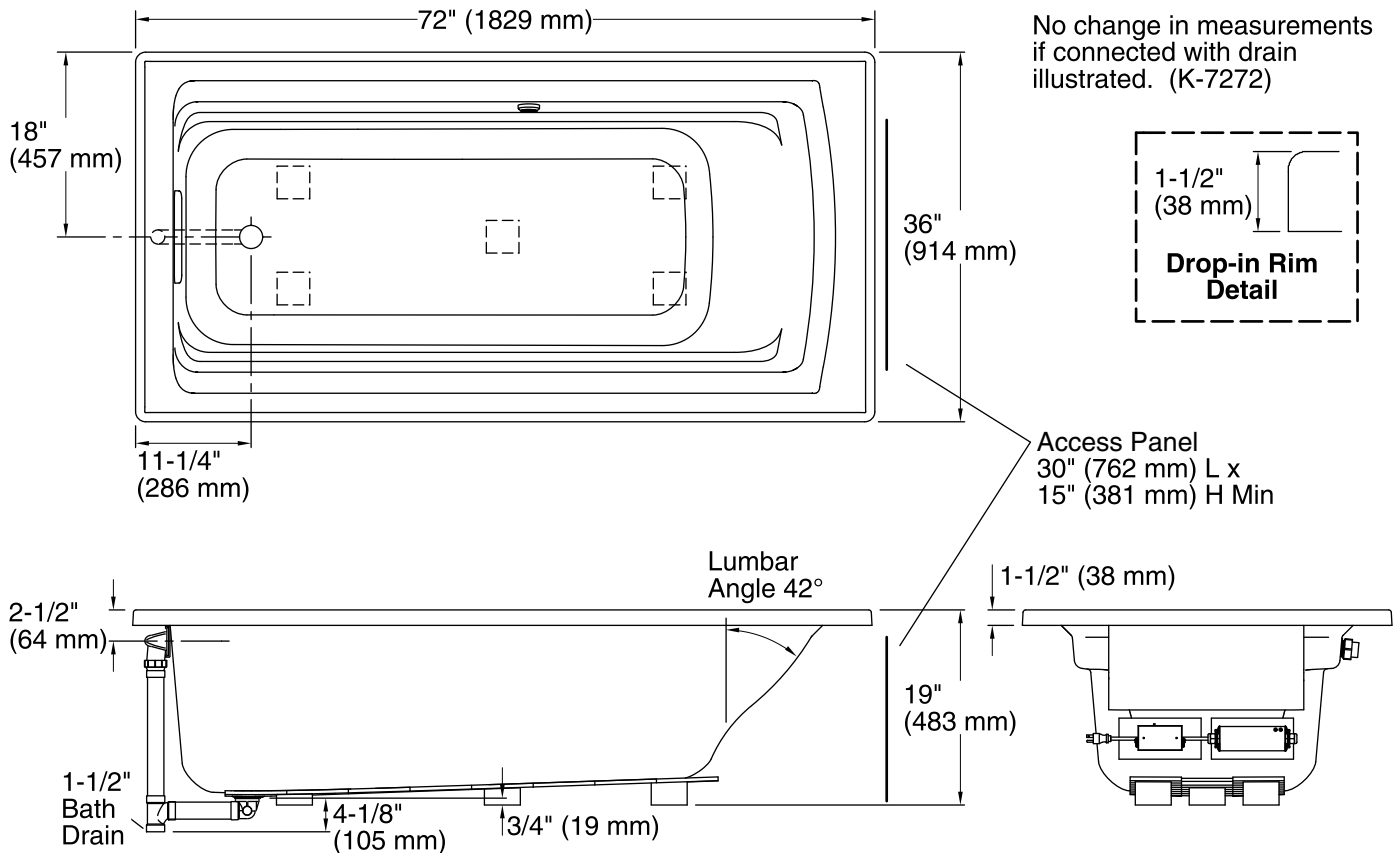

Required Electrical Service

One circuit required, protected with Class A Ground-Fault Circuit-Interrupter (GFCI) or Residual Current Device (RCD).

Heated Surface: 120 V, 15 A

Technical Information

All product dimensions are nominal.

Installation:	Drop-in
Drain location:	End
Basin area, bottom:	51-3/8" x 21" (1305 mm x 533 mm)
Basin area, top:	64-1/2" x 30-1/2" (1638 mm x 775 mm)
Weight:	70 lbs (31.8 kg)
Minimum floor load:	40 lbs/ft ² (195.3 kg/m ²)
Water depth:	15" (381 mm)
Water capacity:	72 gal (272.5 L)
Cutout:	Drop-in, 70-1/2" x 34-1/2" (1791 mm x 876 mm)
Electrical component rating:	Heated Surface: 120 V, 0.5 A, 60 Hz, 65 W
Minimum flat for door:	1-9/16" (40 mm)

Notes

Measure your actual product for rough-in details.

Install this product according to the installation instructions.

The hot water supply should be 70% of the capacity of the bath or greater. Installations will vary.

Provide one grounded electrical outlet within 24" (610 mm) of each component.

This bath is designed for drop-in installation only. It is not suited for use in a three wall alcove with an overhead shower.

ADA compliant when installed to the specific requirements of these regulations.