

### Features

- Metal construction.
- Brass valve bodies.
- Quarter-turn washerless ceramic disc valves.
- For 4" (102 mm) centers.
- 4-1/2" (114 mm) spout reach.
- ADA compliant lever handles.
- Pop-up drain with lift rod and tailpiece.
- 1.5 gal/min (5.7 l/min) maximum flow rate [max at 60 psi (4.14 bar)].

### Optional Accessories

12005



ADA

### Codes/Standards

ASME A112.18.1/CSA B125.1

NSF 61

NSF 372

All applicable US Federal and State material regulations

DOE - Energy Policy Act 1992

EPA WaterSense®

California Energy Commission (CEC)

ADA









ICC/ANSI A117.1

### KOHLER® Faucet Lifetime Limited Warranty

See website for detailed warranty information.

### Available Color/Finishes

*Color tiles intended for reference only.*

Color	Code	Description
	CP	Polished Chrome
	PB	Vibrant® Polished Brass
	VF	Polished Brass
	G	Brushed Chrome
	BN	Vibrant® Brushed Nickel
	BV	Vibrant® Brushed Bronze
	BX	Vibrant® Brazen Bronze
	CB	Polished Chrome with Vibrant® Polished Brass Accents

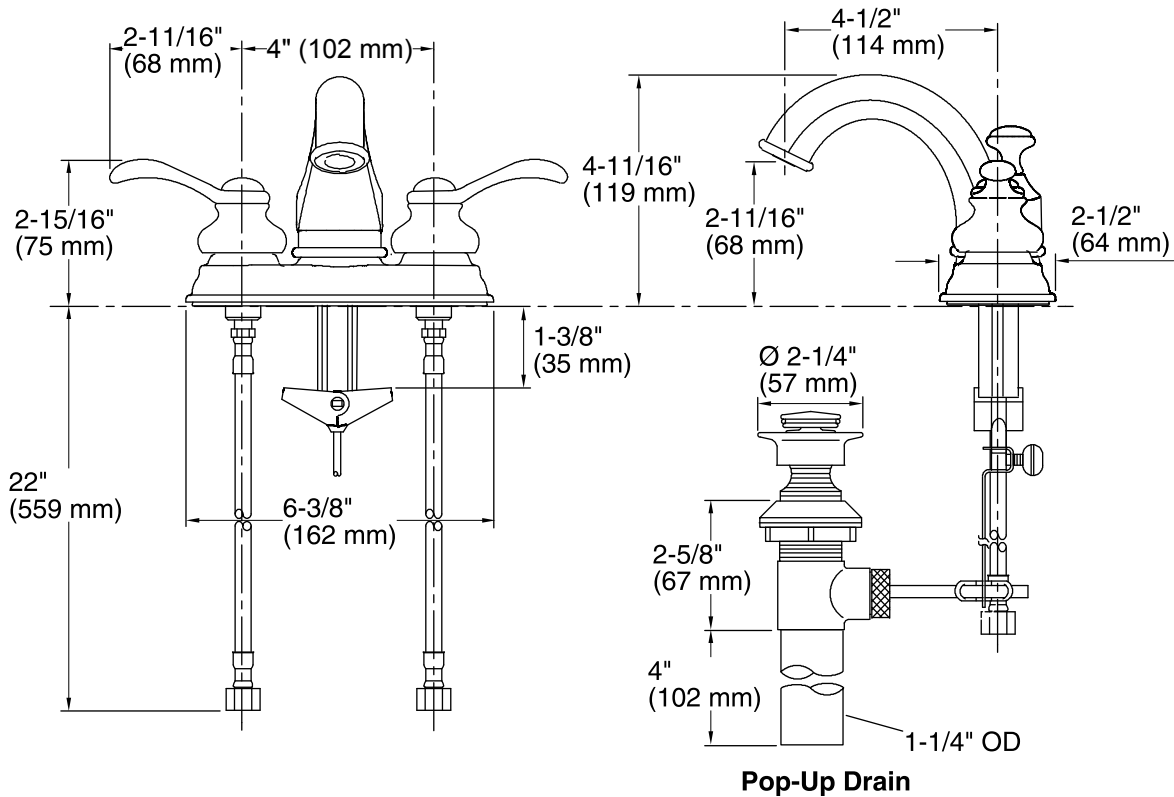

## Technical Information

All product dimensions are nominal.

Drain included: YES

Drain tailpiece included: YES

## Spout:

Spout reach: 4-1/2" (114 mm)

Handle clearance: 2-11/16" (68 mm)

## Faucet:

Flow rate: 1.5 gal/min (5.7 l/min)

Pressure: 60 psi (4.1 bar)

## Notes

Install this product according to the installation guide.

ADA compliant when installed to the specific requirements of these regulations.