

### Features

- Oval basin with unglazed underside.
- Overflow drain.
- Fits standard 14- x 17-inch countertop cutout.

### Material

- Vitreous china.

### Installation

- Under-mount

### Recommended Products/Accessories

K-8998 P-Trap

### Components

Additional included component/s: 1193643 Basin Clamps.



ADA CSA B651

### Codes/Standards











ASME A112.19.2/CSA B45.1  
ADA  
ICC/ANSI A117.1  
CSA B651

### KOHLER® One-Year Limited Warranty

See website for detailed warranty information.

### Available Colors/Finishes

*Color tiles intended for reference only.*

Color	Code	Description
	0	White
	96	Biscuit
	47	Almond
	NY	Dune
	95	Ice™ Grey
	G9	Sandbar
	33	Mexican Sand™
	K4	Cashmere
	58	Thunder™ Grey
	7	Black Black™

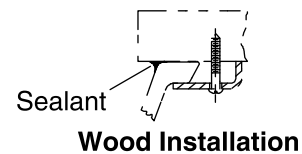
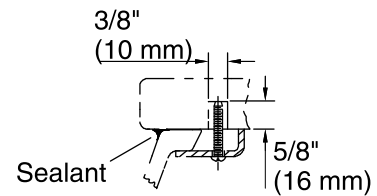
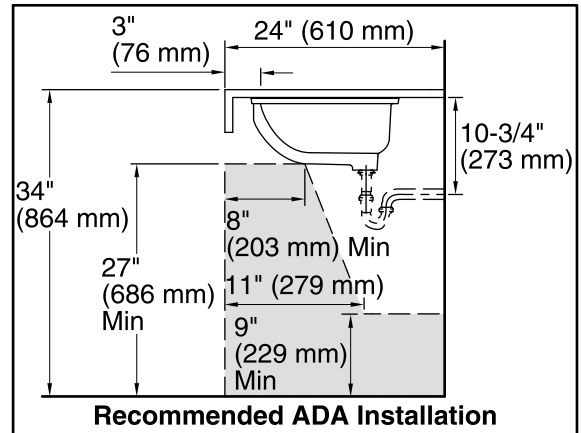
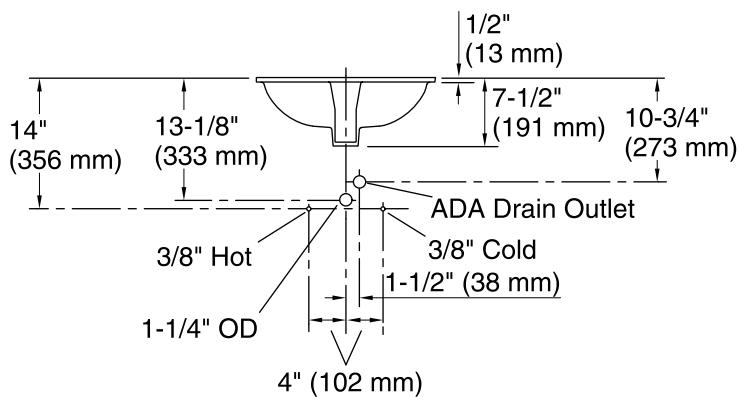
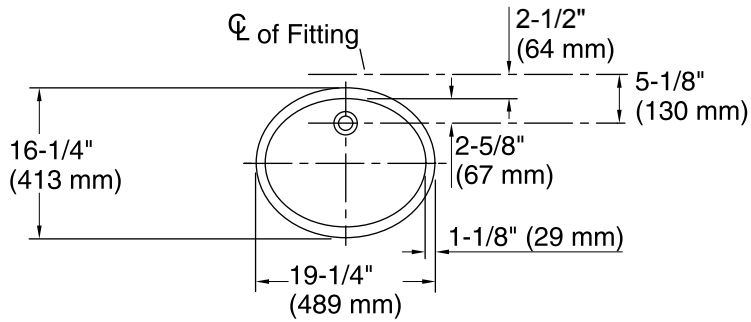

### Technical Information

All product dimensions are nominal.

Installation:	Under-mount
Bowl area:	Length: 17" (432 mm) Width: 14" (356 mm) With overflow: Yes Water depth: 4" (102 mm)
Bowl area:	With overflow: Yes
Drain hole:	1-3/4" (44 mm)
Template:	1151011-7, required, not included

### Notes

Install this product according to the installation instructions.

**NOTICE:** Countertop manufacturer or cutter must use the current product template available at [www.kohler.com](http://www.kohler.com), or by calling 1-800-4KOHLER. Kohler Co. is not responsible for cutout errors when the incorrect cutout template is used.

ADA, CSA B651 compliant when installed to the specific requirements of these regulations.