

Product information presented here reflects conditions at time of publication. Consult factory regarding discrepancies or inconsistencies.

**PUMP COMPANY**

Zoeller Family of Water Solutions™

MAIL TO: P.O. BOX 16347 • Louisville, KY 40256-0347  
 SHIP TO: 3649 Cane Run Road • Louisville, KY 40211-1961  
 (502) 778-2731 • 1 (800) 928-PUMP • FAX (502) 774-3624

visit our web site:  
[www.zoeller.com](http://www.zoeller.com)

## SUMP/SEWAGE BASINS

### COMPARE THESE FEATURES







- Available in high density polyethylene structural foam (PSF), polyethylene or fiberglass
- Ideal for residential, commercial and industrial applications
- Complete with necessary sealing hardware and flanges
- Available with 2" or 3" vent and 2" or 3" discharge
- Lid with gasket and 4" cast iron inlet hub with anticorrosion coating are included with the sewage basins
- Centerline of hub is located 10½" from top of basin (std.). Custom locations available
- Polyethylene sewage pump basins are IAPMO approved. For 10' stack test models, refer to charts on pages 2 and 3
- Sealed (Radon) basins for sump pumps in 18" x 22" and 18" x 30" sizes
- Polyethylene sump basin available with plastic unsealed covers in 18" x 22"
- Sewage basins are watertight and gastight when properly installed
- Durable steel cover with gasket standard on simplex and duplex sewage basins
- One piece, seamless construction on all basins
- Duplex covers include two pump plates and inspection plate
- Ready to install for economical and simple installation
- Dimensional Engineering data available
- Temperature rated 130°F
- Fiberglass models available that will pass the 10' water stack test (Refer to charts on pages 2 and 3) (L. A. - RR-5311)
- Various custom diameters & lengths available in fiberglass, consult factory. Also with 10' water stack test.

**CONSULT FACTORY FOR LARGER SIZE BASINS OR SPECIAL APPLICATIONS.**

18" SUMP BASIN COVERS AND EXTENSIONS			
One Piece, Polyethylene Molded with 3" x 13" Opening.  P/N 17-0135	One Piece, Steel with 3" Vent, 1½" Discharge, and Cord Grommet (Radon Lid).  P/N 17-0131	One Piece, Polyethylene with 1½" Discharge and Cord Grommet.  P/N 17-0294	Basin Extensions, for use with PSF 18" diameter basins: 31-1476 - 6" riser extension w/ hardware. 31-1473 - 12" riser extension w/ hardware.  P/N 31-1476
SUMP AND RADON BASINS		SEWAGE BASINS	
18" x 22" Heavy Duty Polyethylene, no inlet hole and hub (P/N 31-0444). 18" x 22" Radon basin with inlet and hub (P/N 31-0251). 18" x 30" Poly, 4" inlet-grommet (loose), no inlet hole. Includes one-piece blank poly cover w/cord seal (P/N 31-1855). 		18" x 30" Premium Basin with Split Cover, AFD, Torque Stops, Black.  P/N 31-1608	

Products may not be exactly as pictured.

**NOTE:** Polyethylene basins should be used for indoor installations only.

SIMPLEX SEWAGE BASINS		DUPLEX SEWAGE BASINS	
18" x 30" Polyethylene Structural Foam (PSF), Polyethylene or Fiberglass 24" x 30" Polyethylene or Fiberglass	   <p style="text-align: center;"><b>COMBO HUB</b> (Poly Structural Foam Only)</p>  <p style="text-align: center;"><b>THREE BOLT HUB</b> FOR DWV PIPE</p>  <p style="text-align: center;"><b>PIPE SEAL HUB</b></p>  <p style="text-align: center;"><b>SNAP-IN HUB</b> (Poly Structural Foam Only)</p>	30" x 36" Polyethylene or Fiberglass 36" x 36" Polyethylene or Fiberglass 48" x 48" Fiberglass	  <p style="text-align: center;"><b>DUPLEX BASIN AND COVER INCLUDES:</b>            Discharge and Vent Flange            Cord Seals            4" Inlet Hub - Cast Iron Shown            Inspection Plate            Gaskets and hardware</p>
<p style="text-align: center;"><b>SIMPLEX BASIN and COVER INCLUDES:</b>            Discharge and Vent Flange            Cord Seal            4" Inlet Hub            Gaskets and hardware</p>			

**18" & 24" DIAMETER BASIN AND COVERS  
 POLYETHYLENE/POLYETHYLENE STRUCTURAL FOAM/FIBERGLASS**

SIMPLEX BASINS & COVERS									
Size	2" Vent		3" Vent		Basin		Covers		4" Inlet
	2" Discharge	2" Discharge	3" Discharge	Style	IAPMO Listed	Style	IAPMO Capable		
18" X 30"	31-0081	N/A	N/A	Poly	N	Steel - Split	N	Cast Iron Hub	
18" X 30"	31-0091	31-0084	31-0082	Poly	Y	Steel - Solid	N	Cast Iron Hub	
18" X 30"	31-0154	31-0157	31-0155	Fiberglass	N	Steel - Split	N	Cast Iron Hub	
18" X 30"	31-0159	31-0162	31-0161	Poly	Y	Steel - Solid - 10' Stack	Y	Pipe Seal	
18" X 30"	31-0214	31-0217	31-0215	Fiberglass	N	Steel - Solid - 10' Stack	Y	Cast Iron Hub	
18" X 30"	31-0608	N/A	N/A	Poly (Integral Side Vent)	N	Poly - Solid	N	Pipe Seal	
18" X 30"	31-0615	N/A	N/A	Poly	Y	Steel - Solid	N	Pipe Seal	
18" X 30"	31-1098	N/A	N/A	PSF	N	Poly - Solid	N	Combo Hub	
18" X 30"	31-1099	31-1101	31-1100	PSF	N	Poly - Split	N	Combo Hub	
18" X 30"	31-1338	31-1338	N/A	PSF	N	Poly - Solid	N	Snap-In Hub	
24" X 24"	31-1997	N/A	N/A	Poly	N	Poly - Solid	N	Pipe Seal	
24" X 30"	31-0004	31-0027	31-0006	Fiberglass	N	Steel - Solid	N	Cast Iron Hub	
24" X 30"	31-0039	31-0042	31-0040	Poly	N	Steel - Solid	N	Cast Iron Hub	
24" X 30"	31-0218	31-0221	31-0219	Fiberglass	N	Steel - Solid -10' Stack	Y	Cast Iron Hub	
24" X 36"	31-1102	31-1104	31-1103	PSF	N	FG - Solid	N	Combo Hub	

SUMP BASINS	
Item No.	Description
31-0444	Polyethylene Basin without Hub & Hole - 18" x 22"
31-0251	Polyethylene Basin with Inlet Hole, without Hub - 18" x 22"

ADDITIONAL INFO FOR PSF BASINS	
Item No.	Description
31-2228	PSF Basin predrilled 4" inlet, no hub, w/ torque stops - 18" x 30"
31-2229	PSF Basin predrilled 4" inlet, no hub, no torque stops - 18" x 30"
31-2325	PSF Basin no hole, no hub, no torque stops - 18" x 30"
31-2379	PSF Basin predrilled 4" inlet, w/ 4" pipe seal, w/ torque stops
31-2380	PSF Basin predrilled 4" inlet, w/ 4" pipe seal, no torque stops

SUMP BASIN COVERS	
Item No.	Description
17-0135	18" Cover - 1 Piece, Polyethylene Molded with 3" x 13" Opening
17-0131	18" Cover - 1 Piece, Steel w/ 3" Vent, 1 1/2" Discharge, & Cord Grommet (Radon Lid)
17-0294	18" Cover - 1 Piece, Polyethylene w/ 1 1/2" Discharge & Cord Grommet



## 30", 36" & 48" DIAMETER BASINS AND COVERS - POLYETHYLENE/FIBERGLASS

DUPLEX BASINS & COVERS								
Size	2" Vent	3" Vent		Basin		Covers		4" Inlet
	2" Discharge	2" Discharge	3" Discharge	Style	IAPMO Listed	Style	IAPMO Capable	
30" X 36"	31-1105	31-1107	31-1106	PSF	N	Solid - FG* - Duplex	N	Combo Hub
30" X 36"	31-0043	31-0046	31-0044	Poly	N	Steel - Solid - Duplex	N	Cast Iron Hub
30" X 36"	31-0071	31-0074	31-0072	Fiberglass	N	Steel - Solid - Duplex	N	Cast Iron Hub
30" X 36"	31-0222	31-0225	31-0223	Fiberglass	N	Steel - Solid - Duplex - 10' Stack	Y	Cast Iron Hub
36" X 36"	31-0047	31-0050	31-0048	Poly	N	Steel - Solid - Duplex	N	Cast Iron Hub
36" X 36"	31-0010	31-0057	31-0011	Fiberglass	N	Steel - Solid - Duplex - 10' Stack	Y	Cast Iron Hub
48" X 48"	31-0124	31-0127	31-0125	Fiberglass	N	Steel - Solid - Duplex - 10' Stack	Y	Cast Iron Hub

Hub Size (Flat Mount - Cast Iron)	Basin Size					
	18"	24"	30"	36"	42"	48"
4"	005198 (Fits all basins with a flat on side)					

Hub Size (Pipe Seal Grommets)	All Basin Sizes	Hole Size Required in Basin
1 1/4"	008813	2"
1 1/4"	009838	3"
1 1/2"	005882	2-1/2"
1 1/2"	009170	3"
2"	005588	3"
3"	005587	4"
4"	005196	5"
6"	009850	7"

Hub Size (Curved Mount - Cast Iron)	Basin Size					
	18"	24"	30"	36"	42"	48"
2"	010749	010749	010749	010749	010749	010749
3"	010124	010124	010124	010124	010124	010124
4"	NA	004997	004997	004997	004997	004997
5"	NA	010125	010125	010125	010125	010125
6"	NA	007818	007818	007818	007818	007818
8"	NA	010057	010057	010057	010057	010057

**CONSULT FACTORY FOR LARGER SIZE  
BASINS OR SPECIAL APPLICATIONS.**

Curved mount requires mounting on curved side of basin.

Hub Size (Combo Hub)	Basin Size (Poly structural foam only)		
	18"	24"	30"
3"	013505	013505	013505
4"	012094	012094	012094

**NOTE:** Basins are not designed to be installed where saturated soil hydrostatic pressure extends above the top of the pit unless the pressure is relieved by an independent drainage system. Basin cover vent and discharge seals may be rubber insert or bolted on flange design.

BASIN DIMENSIONS								
Available in:		Size	Gallon Capacity	A	B	C	D	E
Str. Foam	Poly							
x	x	18" x 30"	30	30"	16 1/2"	18"	22"	10 1/2"
NA	x	24" x 30"	60	30"	24"	26"	30"	10 1/2"
x	NA	24" x 36"	72	36"	22 1/2"	25 1/2"	30"	10 1/2"
NA	x	30" x 36"	108	36"	30"	32"	36"	10 1/2"
NA	x	36" x 36"	159	36"	36"	38"	42"	10 1/2"
NA	NA	48" x 48"	376	48"	48"	48 1/2"	55 1/2"	10 1/2"

BASIN DIMENSIONS							
Fiber Glass	Size	Gallon Capacity	A	B	C	D	E
x	18" x 30"	30	30"	18"	18"	22"	10 1/2"
x	24" x 30"	60	30"	24"	24"	30"	10 1/2"
x	30" x 36"	108	36"	30"	30"	36"	10 1/2"
x	36" x 36"	159	36"	36"	36"	42"	10 1/2"
x	48" x 48"	376	48"	48"	48"	55 1/2"	10 1/2"

THICKNESS OF BASINS			
Size	PSF	Poly	Fiberglass
18" x 30"	0.200	0.200	0.188
24" x 30"	N/A	0.200	0.188
24" x 36"	0.250	N/A	N/A
30" x 36"	0.312	0.230	0.188
36" x 36"	N/A	0.230	0.188
48" x 48"	N/A	N/A	0.250

THICKNESS OF COVERS					
Size	Steel Split	Steel Solid	Poly Solid	Poly Split	Fiberglass
18"	0.075	0.115	0.345	0.312	N/A
24"	N/A	0.115	N/A	0.343	N/A
30"	N/A	0.125	N/A	N/A	0.250
36"	N/A	0.125	N/A	N/A	0.375
48"	N/A	0.250	N/A	N/A	0.500

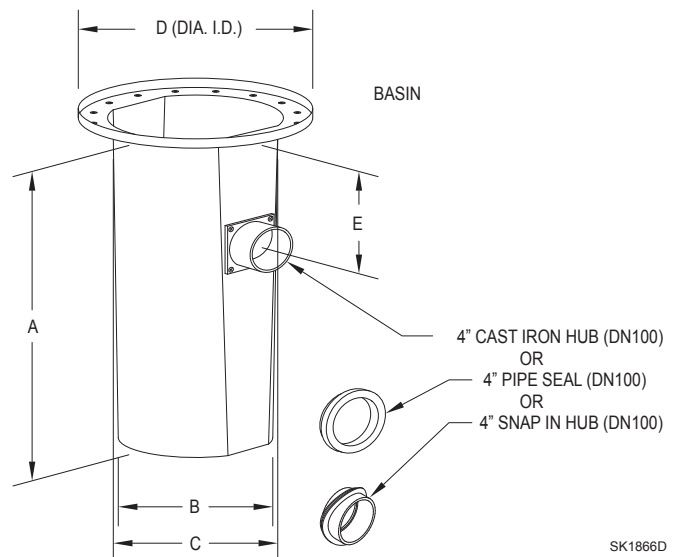

# OUTDOOR BASINS AND ACCESSORIES

## SIMPLEX OUTDOOR BASINS - FIBERGLASS ONLY - NO HOLES DRILLED

Size	Item No.	Description
24" X 48"	31-0866	Solid Fiberglass Basin with Solid Fiberglass Cover and Anti-Flotation Ring
24" X 60"	31-0946	Solid Fiberglass Basin with Solid Fiberglass Cover and Anti-Flotation Ring
24" X 72"	31-0594	Solid Fiberglass Basin with Solid Fiberglass Cover and Anti-Flotation Ring
30" X 48"	31-1830	Solid Fiberglass Basin with Solid Fiberglass Cover and Anti-Flotation Ring
30" X 60"	31-1831	Solid Fiberglass Basin with Solid Fiberglass Cover and Anti-Flotation Ring
30" X 72"	31-1586	Solid Fiberglass Basin with Solid Fiberglass Cover and Anti-Flotation Ring

All basins include 5 field installed adapta-flex seals - (1) 1 1/4", (1) 1 1/2", (2) 2" and (1) 4" grommets.

## DUPLEX OUTDOOR BASINS - FIBERGLASS ONLY - NO HOLES DRILLED

Size W X H	Item No.	Description
36" X 48"	31-1450	Solid Fiberglass Basin with Solid Fiberglass Cover and Anti-Flotation Ring
36" X 60"	31-1451	Solid Fiberglass Basin with Solid Fiberglass Cover and Anti-Flotation Ring
36" X 72"	31-1452	Solid Fiberglass Basin with Solid Fiberglass Cover and Anti-Flotation Ring

All basins include 5 field installed adapta-flex seals - (1) 1 1/4", (1) 1 1/2", (2) 2" and (1) 4" grommets.

ADDITIONAL BASIN SIZES WITH OPTIONS (i.e. Rail Studs) ARE AVAILABLE. CONSULT FACTORY.

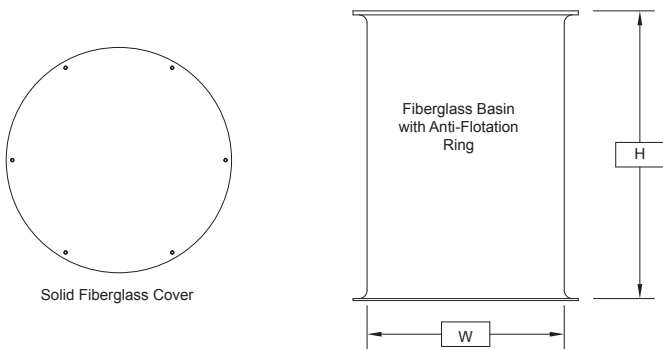

SK2278

OUTDOOR

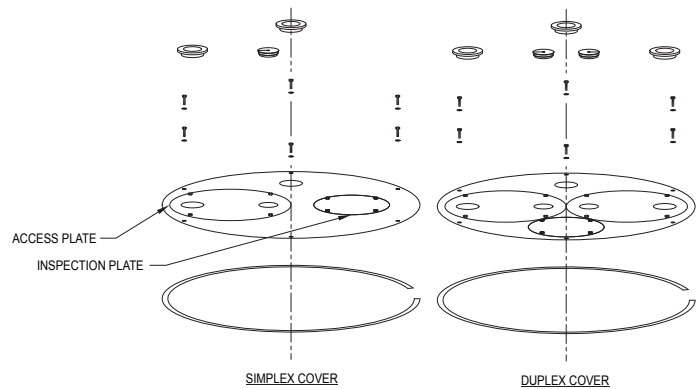

SK1866B

INDOOR

## OUTDOOR TANK VENTS

Item No.	Color	Material	Size	Dimension (W x H)	Pipe Area	Screen Area
10-1753	Black	Plastic	2" Female NPT	4.625" X 3.125"	3.1 sq. in.	6.9 sq. in.
10-1461	Green	Metal	2" Female NPT	4.625" X 3.125"	3.1 sq. in.	6.9 sq. in.
10-1462	Green	Metal	3" Female NPT	6.875" X 4.500"	7.1 sq. in.	19.6 sq. in.
10-1463	Green	Metal	4" Female NPT	9.250" X 5.000"	12.6 sq. in.	35.8 sq. in.
10-1464	Green	Metal	6" Female NPT	11.125" X 6.625"	28.3 sq. in.	42.5 sq. in.



PUMP COMPANY

MAIL TO: P.O. BOX 16347 • Louisville, KY 40256-0347  
SHIP TO: 3649 Cane Run Road • Louisville, KY 40211-1961  
(502) 778-2731 • 1 (800) 928-PUMP • FAX (502) 774-3624

Your Peace of Mind is Our Top Priority®

visit our web site:  
[www.zoeller.com](http://www.zoeller.com)