

Material

- Generator is constructed of insulated stainless steel, which maintains the temperature while ensuring the case is safe to the touch.
- KOHLER finishes resist corrosion and tarnishing.

Technology

- Fast-Response® technology produces a luxurious steam shower in 60 seconds.
- Power Clean™ technology offers one-touch automatic cleaning and safe maintenance.
- Constant Steam produces steam at a consistent rate, which greatly minimizes temperature fluctuations.

Installation

- 447 cubic feet maximum volume rating for custom showering applications.

Required Products/Accessories

K-5557 steam generator control kit

or

K-5548-K1 Steam adapter kit

Recommended Products/Accessories

K-5562 Large Drain Pan



Codes/Standards

UL 499

CSA C22.2 No. 64

KOHLER® Steam Generator Three-Year Limited Warranty

See website for detailed warranty information.

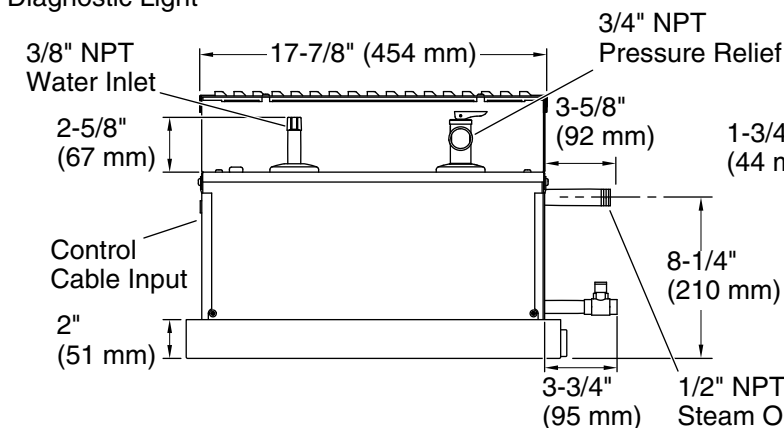
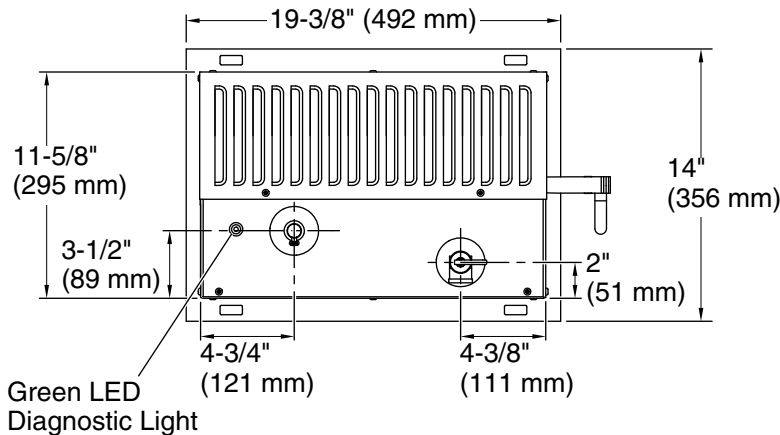

Minimum required access panel is 24" (610 mm) L x 15" (381 mm) H.

Allow for a minimum of 12" (305 mm) of space around all sides of the steam generator.

Allow for the drain/spill pan.

KOHLER® drain pan (shown) sold separately.

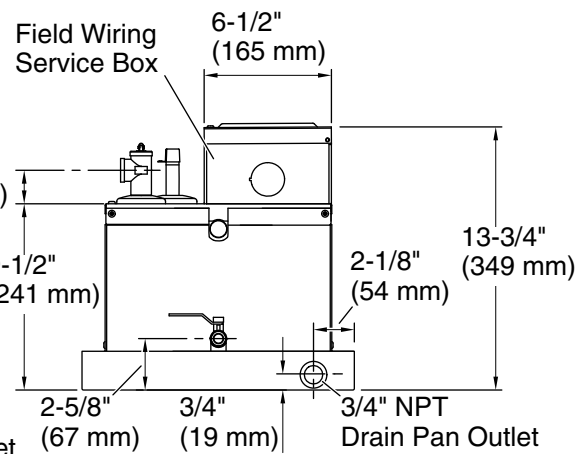

Required Electrical Service

One dedicated circuit required.

240 V, 80 A, 50/60 Hz

Technical Information

All product dimensions are nominal.

Power source: Hardwire - AC, not included

Max. Ambient temp: 104°F (40°C)

Max. Relative humidity non-condensing: 95%

Notes

Install this product according to the installation guide.

Steam room volume for this generator is 447 cubic feet (12.7 cubic meters).

For every foot of ceiling height over 8 ft (2.4 m), use the next larger steam unit.

For optimum performance, the steam generator must be installed within 25 ft (7.62 m) of the steam head.

Recommended feed water quality should be: Hardness: 60 ppm (3.4 gpg). Total Alkalinity: 150 ppm (8.8 gpg). To ensure proper operation, the feed water supply should be tested prior to operating the steam generator. If feed water quality is not within the specified limit, contact a reputable water treatment company for treatment options.

Maximum inlet pressure is not to exceed 70 psi (483 kPa).

For supply connection, use 90 degree C copper wire.