

# ELKAY® SPECIFICATIONS

## Pacemaker® Single Bowl Sinks Models PSR and PSRQ Series, and PSRADQ – A.D.A. Compliant Series

### GENERAL

Fine quality sink bowl formed of #20 gauge, type 304 (18-8) nickel bearing stainless steel. Self-rimming.

### DESIGN FEATURES

Bowl Depth: 7-1/4" (PSRS(Q)3322), 7-1/2" (PSR(Q)2521 and PSR(Q)2522), 5-1/2" (PSRADQ1919), 7-1/8" (all others).

Coved Corners: 1-3/4" vertical and horizontal radius.

Bowl and Faucet Deck Recess: 3/8" (PSR(Q)2522); 3/16" (all others) below outside edge of sink.

Finish: Exposed surfaces are polished to a lustrous highlighted satin finish.

Underside: Fully undercoated to dampen sound and prevent condensation. PSR(Q)2521 and PSR(Q)2522 are fully protected by heavy duty Sound Guard® undercoating.

### OTHER

Drain Opening: 3-1/2" (see back page for location).

NOTE: Unless otherwise specified, models with one, two, three or OS4 faucet hole option are furnished with 3 faucet holes as standard; models with choice of one, two, three, four or five faucet hole option are furnished with 4 faucet holes as shown.

These sinks comply with ANSI Standard A112.19.3.

### SINK DIMENSIONS (INCHES)\*

U-Channel Model Number	Quick-Clip® Model Number	Overall		Inside Bowl			Cutout in Countertop (1 1/2" Radius Corners)		No. of 1 1/2" Dia. Faucet Holes 4" Centers	Minimum Cabinet Size
		L	W	L	W	D	L	W		
		A	B	C	D	E				
PSR1517	PSRQ1517	15	17 1/2	12	12	7 1/8	14 3/8	16 7/8	1, 2, MR2 or 3	18
PSR1716	PSRQ1716	17	16	14	10	7 1/8	16 3/8	15 3/8	1, 2, MR2, 3 or OS4	21
PSR1720	PSRQ1720	17	20	14	14	7 1/8	16 3/8	19 3/8	1, 2, MR2, 3 or OS4	21
PSR1722	PSRQ1722	17	22	13 1/2	16	7 1/8	16 3/8	21 3/8	1, 2, MR2, 3 or OS4	21
PSR1918	PSRQ1918	19	18	16	11 1/2	7 1/8	18 3/8	17 3/8	1, 2, MR2, 3 or OS4	24
PSR2219	PSRQ2219	22	19 1/2	18	14	7 1/8	21 3/8	18 7/8	1, 2, MR2, 3, 4 or 5	27
PSR2222	PSRQ2222	22	22	19	16	7 1/8	21 3/8	21 3/8	1, 2, MR2, 3, 4 or 5	27
PSR2521	PSRQ2521	25	21 1/4	21	15 3/4	7 1/2	24 3/8	20 5/8	1, 2, MR2, 3, 4 or 5	30
PSR2522	PSRQ2522	25	22	21	15 3/4	7 1/2	24 3/8	21 3/8	1, 2, MR2, 3, 4 or 5	30
PSR3122	PSRQ3122	31	22	28	16	7 1/8	30 3/8	21 3/8	1, 2, MR2, 3, 4 or 5	36
Not Available	PSRADQ191955L	19 1/2	19	16	13 1/2	5 1/2	18 7/8	18 3/8	1, 2, MR2, 3 or OS4	24
Not Available	PSRADQ191955R	19 1/2	19	16	13 1/2	5 1/2	18 7/8	18 3/8	1, 2, MR2, 3 or OS4	24
PSRS3322	PSRSQ3322	33	22	28	16	7 1/4	32 3/8	21 3/8	1, 2, MR2, 3, 4 or 5	36

\*Length is left to right. Width is front to back.

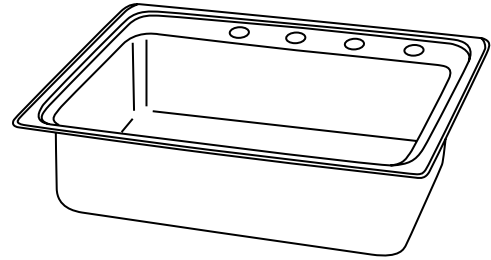

Model PSR(Q)25214

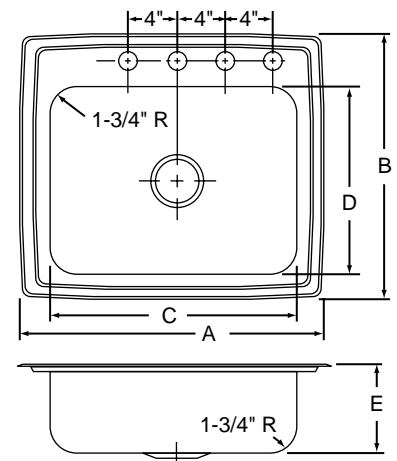

THIS PRODUCT, AS CONSTRUCTED IS SUBJECT TO INTERPRETATION OF A.D.A. REQUIREMENTS.  
THE UNOBSTRUCTED KNEE SPACE REQUIRED TO SATISFY A.D.A. STANDARDS MAY NOT BE DESIRABLE.

ALL DIMENSIONS IN INCHES, TO CONVERT TO MILLIMETERS MULTIPLY BY 25.4.

In keeping with our policy of continuing product improvement, Elkay reserves the right to change product specifications without notice.

This specification describes an Elkay product with design, quality and functional benefits to the user. When making a comparison of other producers' offerings, be certain these features are not overlooked.

**HOLE DRILLING CONFIGURATIONS**

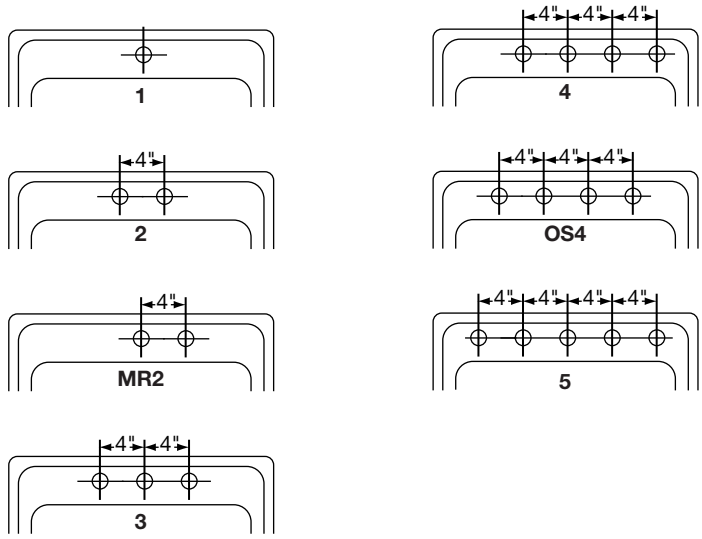

**DRAIN OPENING LOCATIONS**

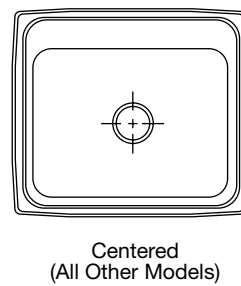
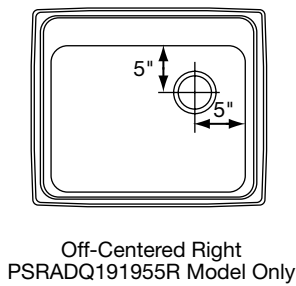
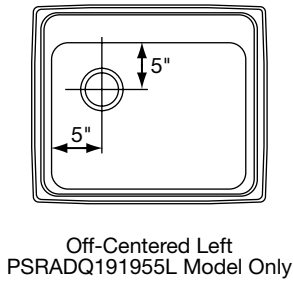

**Quick-Clip® Mounting System**

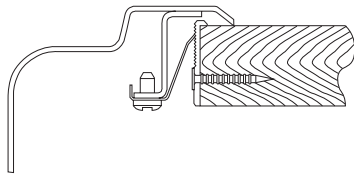

**U-Channel Type Mounting System**

