

### Features

- Works with KOHLER filtration systems or as a cold water tap
- Integrated air gap offers reverse osmosis (RO) compatibility
- KOHLER ceramic disc valves exceed industry longevity standards by over two times, ensuring durable performance for life
- 1.5 gpm (5.7 lpm) maximum flow rate at 60 psi (4.14 bar)
- Faucet spout rotates 360° and offers clearance for filling glasses and pitchers
- Right-side lever handle
- Coordinates with other products in the Components collection

### Material

- Premium metal construction for durability and reliability
- KOHLER finishes resist corrosion and tarnishing

### Installation

- Single-hole installation

### Recommended Products/Accessories

K-22155 Reverse osmosis (RO) water filtration system

### Optional Products/Accessories

K-29638 Two-stage water filtration system  
K-77686 Double-cartridge water filtration system  
K-77685 Single-cartridge water filtration system



**ADA** **CSA B651**

### Codes/Standards









ASME A112.18.1/CSA B125.1  
NSF/ANSI/CAN 61  
NSF/ANSI/CAN 372  
DOE - Energy Policy Act 1992  
California Energy Commission (CEC)  
ADA  
ICC/ANSI A117.1  
CSA B651

### KOHLER® Faucet Lifetime Limited Warranty

See website for detailed warranty information.

### Available Colors/Finishes

*Color tiles intended for reference only.*

Color	Code	Description
	CP	Polished Chrome
	SN	Vibrant® Polished Nickel
	AF	Vibrant® French Gold
	VS	Vibrant® Stainless
	BV	Vibrant® Brushed Bronze
	BL	Matte Black
	2MB	Vibrant® Brushed Moderne Brass
	BMB	Matte Black with Moderne Brass
	TT	Vibrant Titanium

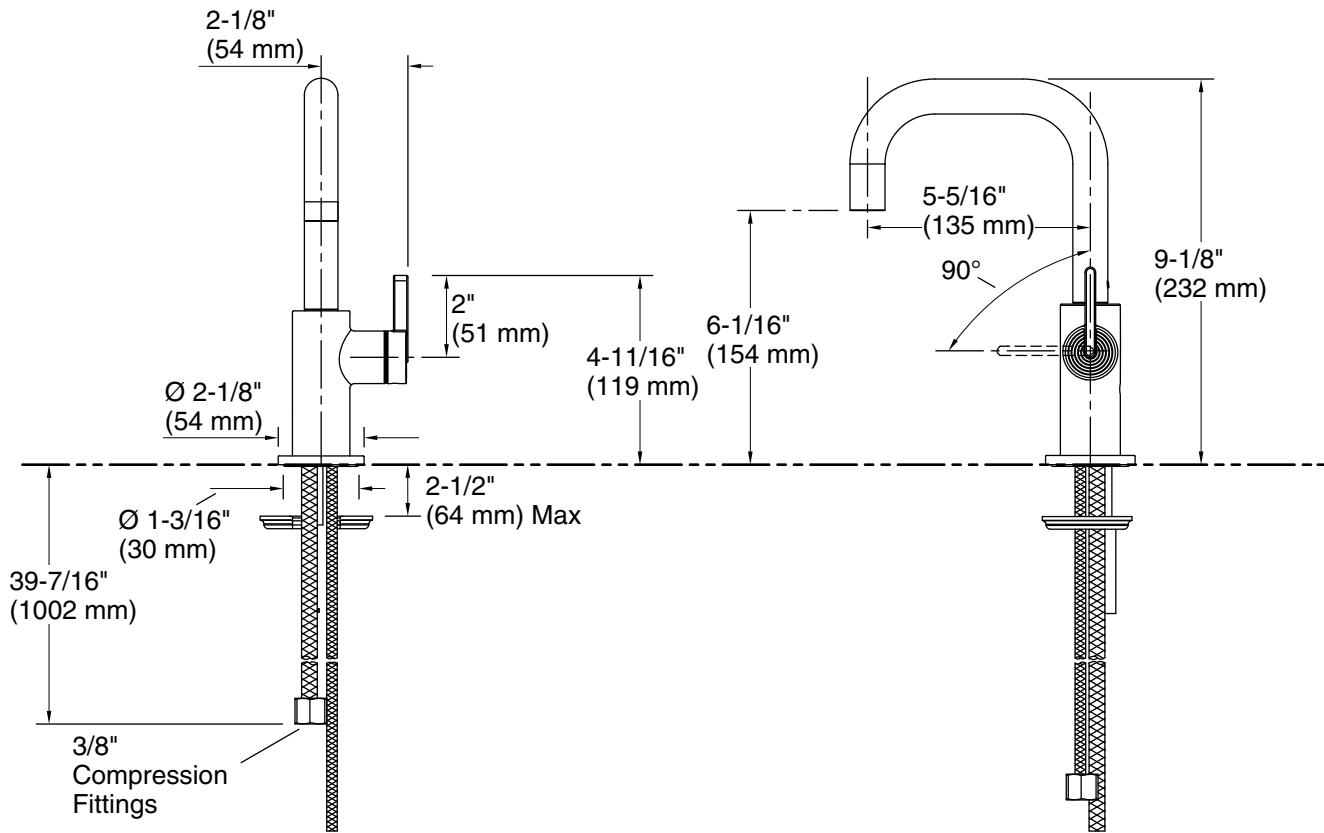

**Technical Information**

All product dimensions are nominal.

Faucet flow rate: 1.5 gal/min (5.7 l/min)

**Spout:**

Spout reach: 5-5/16" (134 mm)

**Notes**

Install this product according to the installation instructions.

ADA compliant for faucet handles only

ADA, CSA B651 compliant when installed to the specific requirements of these regulations.