

## Features

- Low-threshold design for easy entry and exit.
- Molded-in textured floor.
- Water containment bead incorporated into threshold design provides an optimum barrier, preventing water from escaping from shower space.
- Single threshold for alcove installation.
- Center drain.
- Coordinates with Choreograph® shower walls and other KOHLER® collections.

## Material

- Acrylic.

## Recommended Products/Accessories

- K-9132 Shower Drain
- K-23726 Drain treatment
- K-23732 Tub & shower cleaner



## Codes/Standards





- CSA B45.5/IAPMO Z124
- ASTM E162
- ASTM E662

## KOHLER® Plastic Baths and Receptors Lifetime Limited Warranty

See website for detailed warranty information.

## Available Colors/Finishes

*Color tiles intended for reference only.*

Color	Code	Description
	0	White
	96	Biscuit
	NY	Dune
	95	Ice™ Grey
	G9	Sandbar

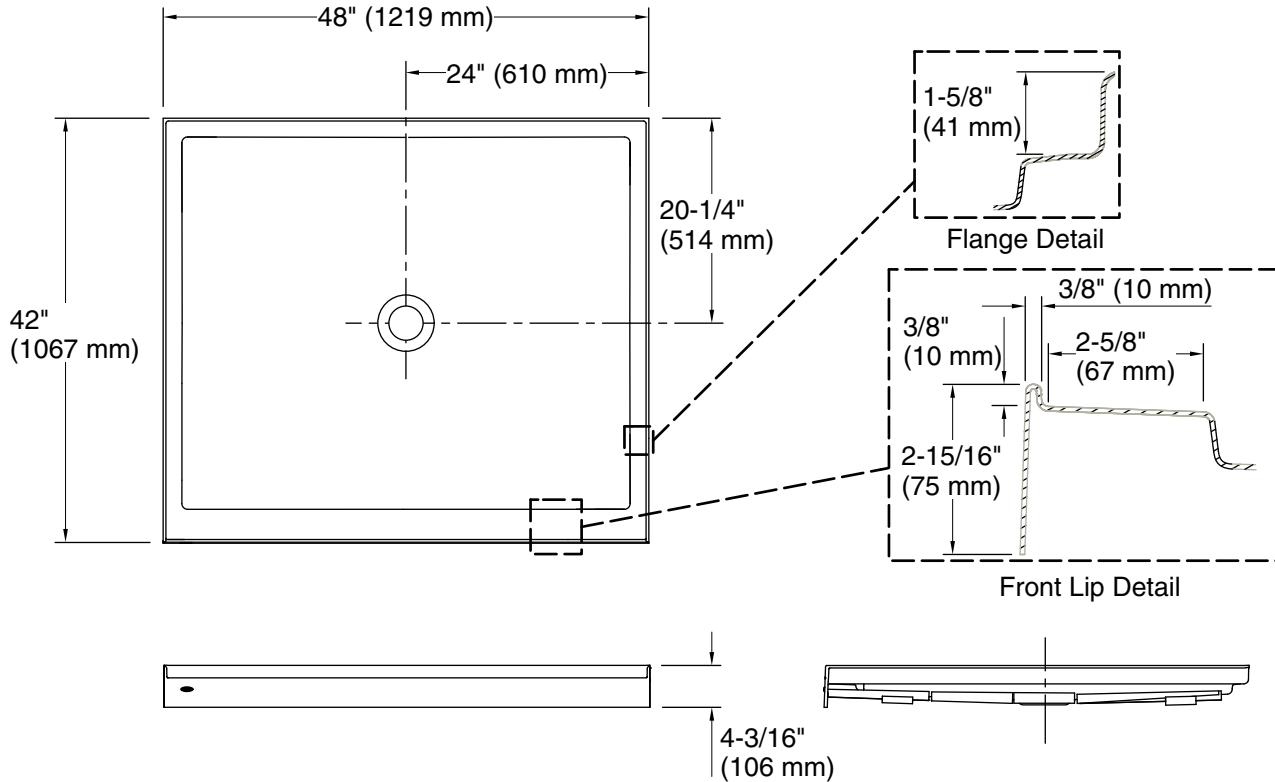

### Technical Information

All product dimensions are nominal.

Installation: Three-wall alcove  
 Drain location: Center  
 Weight: 59 lbs (26.8 kg)

### Notes

Measure your actual product for rough-in details.

Install this product according to the installation instructions.

Subfloor must be within 1/2" (13 mm) of level.

This receptor has a front lip. This should be taken into account when installing a shower door.