

Features

- Patented K-joint installation ensures consistent trim appearance, regardless of variability in valve rough-in
- Wall-mount installation
- Ergonomic lever handle is ADA-compliant
- Trim requires valve to complete

Required Accessories

K- 728-K Three-Way/Two-Way Transfer Valve



ADA

CSA B651

OBC

Codes/Standards

ASME A112.18.1/CSA B125.1

ADA

ICC/ANSI A117.1

CSA B651







OBC

Kohler Faucet Lifetime Limited Warranty

See website for detailed warranty information.

Available Color/Finishes

Color tiles intended for reference only.

Color	Code	Description
	CP	Polished Chrome
	SN	Vibrant® Polished Nickel
	PB	Vibrant® Polished Brass
	G	Brushed Chrome
	BN	Vibrant® Brushed Nickel
	BV	Vibrant® Brushed Bronze
	BX	Vibrant® Brazen Bronze

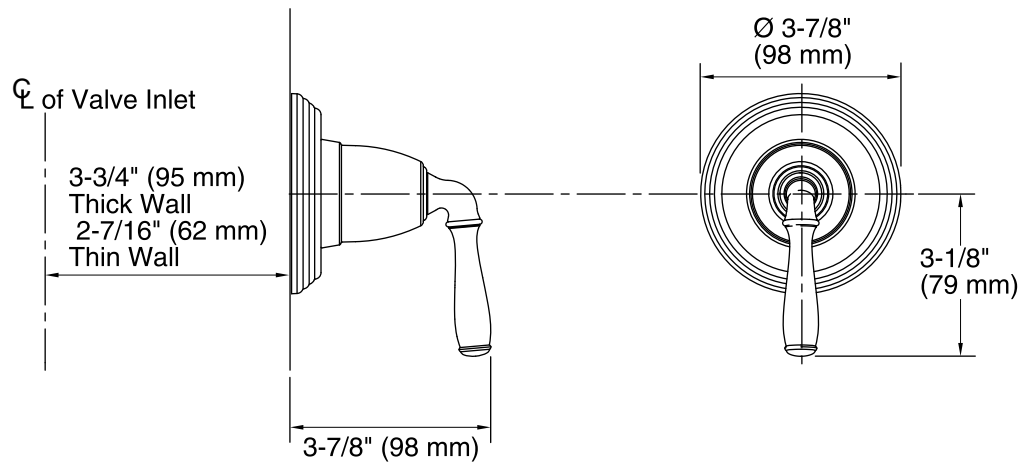

Technical Information

All product dimensions are nominal.

Notes

Install this product according to the installation guide.

ADA, OBC, CSA B651 compliant when installed to the specific requirements of these regulations.