



Underscore® Rectangle

60" x 30" Heated BubbleMassage™ air bath
K-1167-GH

Features

- 122 airjets release thousands of heated bubbles that surround, support, and massage the body.
- Variable-speed blower lets you adjust massage intensity to 18 levels.
- Built-in heater.
- Automatic and manual purge cycles remove residual water from air channels after use.
- 60-minute automatic shutoff timer.
- Slotted overflow allows for deep soaking.
- Integral lumbar support.
- Keypad control.
- Textured bottom surface.

Material

- Acrylic.

Technology

- Heated BubbleMassage™ technology warms and humidifies air before it enters the bath.

Installation

- Drop-in or undermount.
- Reversible drain.

Required Products/Accessories

K-7271 Brass Slotted Overflow Bath Drain

or

K-7272 PVC Slotted Overflow Bath Drain

Recommended Products/Accessories

- K-1491 Bath/Whirlpool Pillow
- K-1601 Bath/whirlpool footstop, removable
- K-1703 Whirlpool Remote Control
- K-531 Under-Mount Installation Kit
- K-9498 3" Keypad Trim
- K-24916 Wireless Music Kit
- K-1705 Whirlpool/BubbleMassage™ Remote Control
- K-702200-G73 Frameless Sliding Bath Door
- K-702200-L Frameless Sliding Bath Door
- K-706000-D3 Frameless Sliding Bath Door
- K-706000-L Frameless Sliding Bath Door
- K-706003-L Frameless Sliding Bath Door
- K-706004-D3 Frameless Sliding Bath Door
- K-706004-L Frameless Sliding Bath Door
- K-706007-L Frameless Sliding Bath Door
- K-1177 Vinyl Tiling-in Bead



ADA

Codes/Standards







ASME A112.19.7/CSA B45.10
CSA B45.5/IAPMO Z124
ASTM E162
ASTM E662
UL 1795
CSA C22.2 No. 218.2
ADA
ICC/ANSI A117.1

KOHLER® Hydrotherapy Components Five-Year Limited Warranty KOHLER® Plastic Baths and Receptors Lifetime Limited Warranty

See website for detailed warranty information.

Available Colors/Finishes

Color tiles intended for reference only.

Color	Code	Description
	0	White
	96	Biscuit
	NY	Dune
	95	Ice™ Grey
	58	Thunder™ Grey
	7	Black Black™

1-800-4KOHLER (1-800-456-4537)

Kohler Co. reserves the right to make revisions without notice to product specifications.

For the most current Specification Sheet, go to www.kohler.com.

THE BOLD LOOK
OF **KOHLER**®

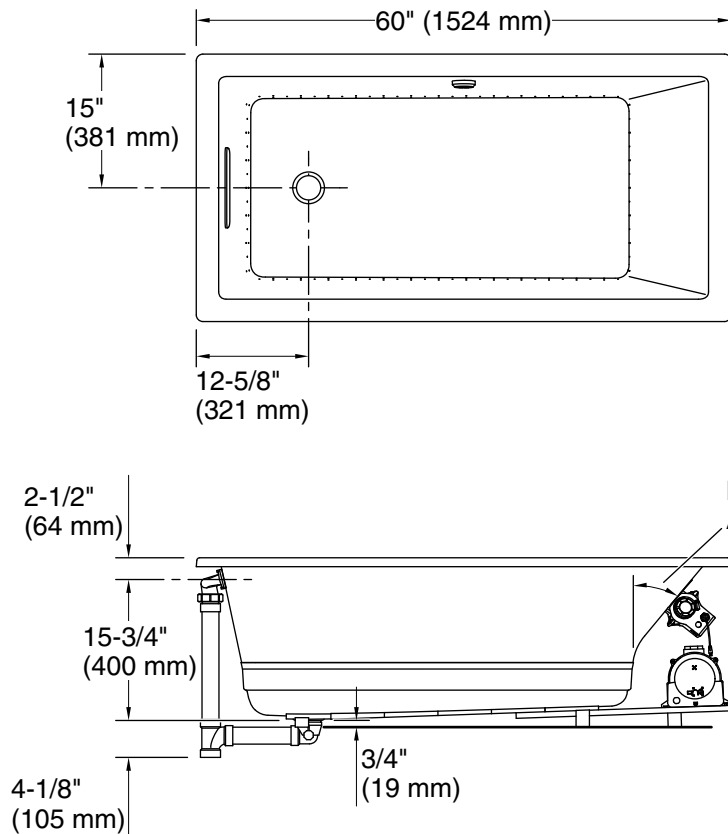

No change in measurements if connected with drain illustrated. (K-7271)

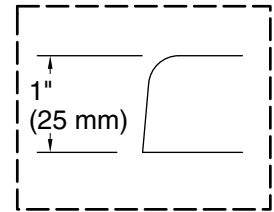

Drop-in Rim Detail

Blower Motor Access
 20" (508 mm) W x 15" (381 mm) H Min

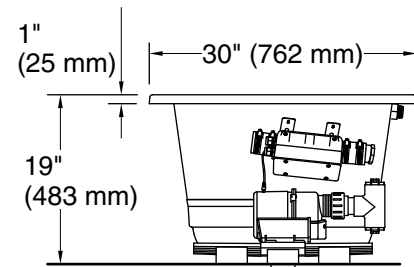

1-1/2" Bath Drain

Required Electrical Service

Two dedicated circuits required, protected with Class A Ground-Fault Circuit-Interrupter (GFCI). Outside North America, this device may be known as a Residual Current Device (RCD).

Blower: 120 V, 15 A, 60 Hz
 Air bath: 120 V, 15 A, 60 Hz

Technical Information

All product dimensions are nominal.

Installation: Drop-in, Undermount
 Basin area, bottom: 42-3/8" x 20" (1076 mm x 508 mm)
 Basin area, top: 54-3/8" x 24-5/16" (1381 mm x 618 mm)
 Weight: 96 lbs (43.5 kg)
 Minimum floor load: 50 lbs/ft² (244.1 kg/m²)
 Water depth: 15-1/16" (383 mm)
 Water capacity: 59.8 gal (226.4 L)
 Cutout: Drop-in, 59-1/2" x 28-1/2" (1511 mm x 724 mm)
 Electrical component rating: Blower: 120 V, 10 A, 60 Hz
 Air bath: 120 V, 5 A, 60 Hz
 Blower speed: Variable

Notes

Measure your actual product for rough-in details.

Install this product according to the installation instructions.

The hot water supply should be 70% of the capacity of the bath or greater. Installations will vary.

ADA compliant when installed to the specific requirements of these regulations.