

Plastic drop ear bend supports

Project information

Job name:	Location:
Engineer:	Date submitted:
Contractor:	Submitted by:
Manufacturer's representative:	Approved by:

Technical data

Material Plastic

Product information and application use

Uponor Plastic Drop Ear Bend Supports are designed to provide a Rigid, 90-degree bend and connection-free stub out from a stud wall or floor for $\frac{3}{8}$ " or $\frac{1}{2}$ " Uponor AquaPEX® tubing.

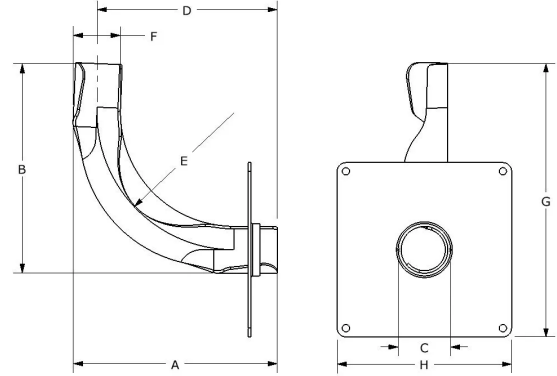

Part name	Part no.	A [Inch]	B [Inch]	C [Inch]	D [Inch]	E [Inch]	F [Inch]	G [Inch]	H [Inch]	Weight per UOM [lbs/UOM]
3/8" Plastic Drop Ear Bend Support	F5200375	3.798	3.879	0.88	3.364	2.475	0.87	4.944	3	0.06
1/2" Plastic Drop Ear Bend Support	F5200500	3.815	3.895	0.885	3.315	2.475	0.435	4.895	3	0.06

Installation

Snap the tubing into the bend support at the beginning of the bend. Continue the bend through the support and snap the tubing into the support at the end of the bend as well. Refer to the Uponor Professional Plumbing Installation Handbook or Uponor Radiant Floor Installation Handbook for additional information.

Related applications

PEX-a Plumbing Systems
 Radiant Floor Heating and Cooling Systems
 AquaSAFE™ Fire Safety Systems

Codes

-

Standards

-

Listings

-

Footnotes

-

Contact information

Uponor Inc.
 5925 148th Street West
 Apple Valley, MN 55124
 T 800.321.4739
 F 952.891.2008

Uponor Ltd.
 6510 Kennedy Road
 Mississauga, ON L5T 2X4
 T 888.594.7726
 F 800.638.9517