



ENGINEERING EXCELLENCE

Installation Guide

Single Handle Tub & Shower Trim Set:





- 4LG100TX
- 4LG300TX
- 4DM100TX
- 4DM200TX
- 4DM300TX

This product meets the following standards:

- ASME A112.18.1
- ANSI A117.1
- CUPC / IAPMO LISTED / ADA COMPLIANT

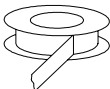
Thank you for purchasing this pioneer quality product.

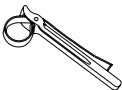
Tools Required

				
Teflon Tape	3/32" Allen Wrench	Strap Wrench	Thermometer	Plumbers Putty

Prior to Installation

- Observe all local plumbing and building codes before you begin installation.
- The finished wall and tub/shower valve(4010B or 4011B) must be installed prior to installing this trim.
- Pioneer reserves the right to make changes in the design of faucets without notice as specified in the pricebook.

Caution: (1). These products may cause personal injury due to scalding if the temperature is set too high. We recommend that temperature is set below 120 ° F (49 ° C).

Trim Installation

- Remove the temporary nipple.
- **For Slip-Fit Installation:-**
- The 1/2" nominal copper tube must be cut with a minimum length of 2-1/2" to maximum length of 2-7/8" from finished wall. This length is for tub spout with tub spout escutcheon application. For tub spout without tub spout escutcheon (B) application minimum length should be 2-1/4" to maximum length of 2-5/8".
- The end of copper tube should be chamfered free of burrs to prevent cutting or nicking o-ring inside the tub spout. The outside surface may be sanded free from nicks and scratches.
- For tub spout with the tub spout escutcheon (B) slide the spout escutcheon (B) along the copper pipe. Press and twist the spout over copper tube flush with the spout escutcheon on the finished wall.
- Tighten the set screw, do not over-tighten.
- **For IPS Installation:-**
- The 1/2" threaded pipe nipple must be kept with the length of 2-1/4" from finished wall. This length is for tub spout with tub spout escutcheon (B) application. For tub spout without tub spout escutcheon (B) application minimum length should be 2".
- Remove the cylindrical round brass adapter inside the spout by using nose plier.
- For tub spout with tub spout escutcheon (B) slide the spout escutcheon (B) along the threaded pipe nipple. Apply Teflon Tape at the threaded connection. Screw Tub spout onto the threaded pipe nipple flush with the spout escutcheon and tighten by strap wrench.

Trim Installation

For 4LG100TX
Slip Fit Installation

Item#	A	B
4LG100T	1-7/8"	2-3/4"

A Minimum to
B Maximum

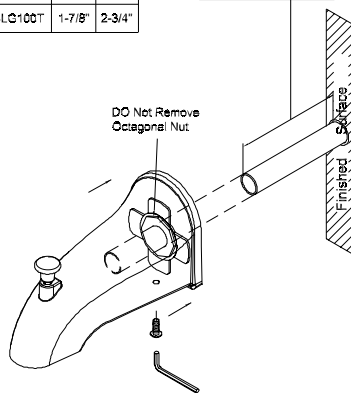

For All Installation

1/2" IPS Installation

Item#	C	D
4LG100T	3/4"	1-3/16"
4DM100T	1-7/8"	2-1/4"

C Minimum to
D Maximum

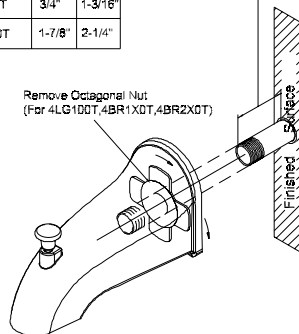

Trim Installation

- Caution:- To avoid plugging the showerhead spray outlet use sealant tape on the shower arm threads.
- Remove temporary nipple from the shower elbow.
- Use silicon to caulk the back of the shower arm flange(C).
- Slide the shower arm flange(C) over the shower arm(D).
- Apply the teflon tape on both threaded ends of the shower arm (D)and install the shower arm(D) to the shower elbow.
- Carefully tighten with a clean strap wrench.
- press the shower arm flange(C) against the finished wall.
- Flush out the system.
- Thread the showerhead(E) to the shower arm(D).

Shower Arm
Flange(C)

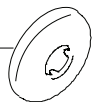

Shower Arm(D)

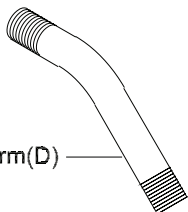

Shower Head(E)

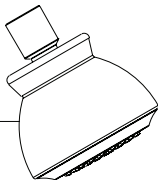

Trim Installation

- Remove the black test plug from the valve.
- Install the pressure balance spool (F). Ensure the o-rings on the pressure balance spool does not get cut or nicked. Tighten the pressure balance spool with the help of $2\frac{1}{32}$ " size socket. Do not overtighten.
- Turn the stem counterclockwise to the full open position.
- Allow water to run for some time until the hot water comes out. Check the temperature with thermometer for the hot water.
- If necessary adjust the temperature limit screw (H). Rotate the temperature limit screw (H) counterclockwise to increase the water temperature and clockwise to decrease the water temperature. Adjust to get the desired water temperature.

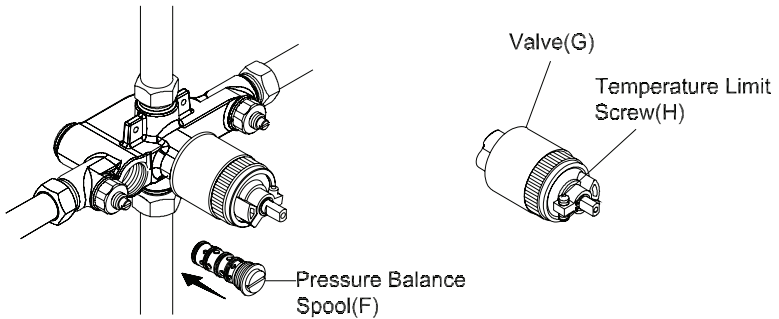

Trim Installation

- Remove the Plastic protective dome if installed.
- Slide the face plate(I) on the valve. Ensure the rubber gasket is placed behind the face plate (I) to form water tight seal.
- Secure the face plate(I) with the help of face plate screws (J). Use silicon to caulk around the face plate (I).
- Place the handle (K) on the stem. Secure the handle by tightening the allen screw (L). For 4DM100T,4DM200T & 4DM300t use 3/32" allen wrench and for 4LG100T & 4LG300T use 1/8" allen wrench.

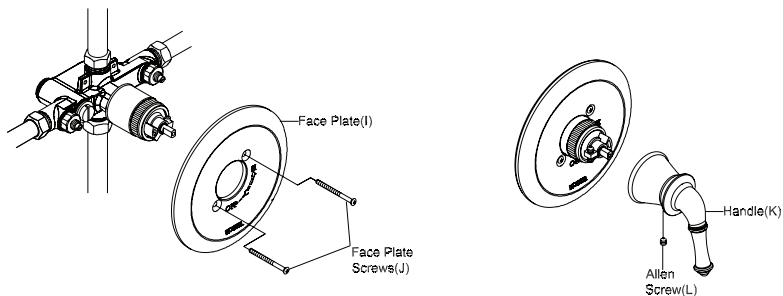

For more care information or trouble shooting inquiries about your Pioneer Product, please see the contact information on the back page.



ENGINEERING EXCELLENCE

3325 S. Garfield Ave. | Commerce, CA 90040
Telephone: (800) 338-9468 | (323) 888-8873 | Fax: (323) 888-9515
Hours: M - F, 7:30am to 5:00pm PST
www.pioneerind.com