

Installation & Operation Instructions Manual
VR15, VR20, VR25 & VR30
(ALL CIRCULATORS ARE AVAILABLE IN LOW, MEDIUM AND HIGH HEAD MODELS)

SUPERSEDES: August 2, 2021

EFFECTIVE: July 6, 2022

Plant ID No. 001-5038

00e[®]
series

ECM High-Efficiency Circulators



TABLE OF CONTENTS

1. Symbols & conventions used in this document	3	13. Controller Layout	18
1.1. Abbreviations and conventions.....	3	13.1 Connection considerations.....	19
2. Introduction	3	13.2 Connection examples.....	19
Section 1 - Installation and Operation	4	14. Control modes and priorities	20
3. General Uses	4	14.1 Priority of settings.....	20
4. Safety	4	14.2 Control variables.....	21
5. Pump Description	5	14.3 Module mode selection.....	22
6. Use	5	14.4 Mode 1.....	23
7. Pumped Fluids	5	14.5 Mode 2.....	27
8. Pump Installation	5	14.6 Mode 3 & 4.....	28
8.1.1 Motor Rotation Procedure.....	6	15. Relay output	31
8.1.2 After Installation into piping.....	7	16. Network	31
9. Electrical Connections	8	16.1. Bus topology.....	32
10. Setup and Operation	9	16.2. Connecting to pump ad-hoc.....	32
10.1 Control Panel Layout.....	9	16.3. Connecting to pump via router.....	32
10.2 Switching the Pump On and Off.....	9	16.4 Local Network Setup, Display & Diagnostics.....	32
10.3 Pump Functions.....	9	17. BACnet	39
10.4 Operation and Mode Selection.....	10	17.1 BACnet MS/TP communication.....	39
10.5 Mode Description.....	10	17.2 Data Link LAYER Option.....	39
10.6 Restoring Factory Settings.....	11	17.3 Device Address Binding.....	40
10.7 Minimum Speed Adjustment.....	11	17.4 Network Options.....	40
10.8 Parallel Pumping.....	12	17.5 Network Security Options.....	40
11. Specifications	14	17.6 Character Sets Supported.....	40
11.1 Application.....	13	17.7 Supported BACnet Interoperability.....	40
11.2 Electrical Ratings.....	14	17.8 Analog Inputs.....	41
11.3 Standards, Protection and Flange Conn.....	15	17.9 Analog Outputs.....	41
11.4 Materials of Construction.....	15	17.10 Binary Inputs.....	42
Section 2 - Controller (VFD) Operation	16	17.11 Binary Outputs.....	42
12. Features	16	18. Modbus	43
12.1 Specifications.....	17	18.1 Modbus Related Interface.....	43
12.2 BACnet Specifications.....	17	18.2 Modbus Topology.....	43
12.3 Modbus Specifications.....	17	18.3 Connection to Modbus.....	44
12.4 Ethernet Specifications.....	17	19. Fault finding	51
12.4 Mode Selection Switch.....	17	19.1 Error codes.....	51
12.5 Analogue Signals.....	18	Performance Curves	53
12.6 Relay Specifications.....	18	Hydraulic Institute Energy Ratings	55
		Limited Warranty Statement	56



WARNING!

Installation and use of this product requires experience and knowledge of this or similar products. Persons with reduced physical, mental or sensory capabilities must not use this product, unless properly instructed and supervised. Children must not be allowed to play with this product.



WARNING!

Prior to installation and commissioning, read these instructions first. Installation and operation must comply with local regulations.

1. SYMBOLS & CONVENTIONS USED IN THIS DOCUMENT



WARNING! Denotes that a failure to observe those instructions might cause damage to equipment or pose danger to the user.

1.1 ABBREVIATIONS AND CONVENTIONS USED IN THIS DOCUMENT

Abbreviation	Description
Baud, Baud rate	Serial communication speed, in bits per second including start, parity and stop bits.
CRC	Cyclic Redundancy Check, additional bytes used to confirm valid data transmission.
Ethernet	IEEE 802.3, mostly referring to 10BASE-T RJ-45 connector present on board.
H	Differential pressure, often called Head.
LED	Light Emitting Diode.
Modbus / BACnet	A serial communication protocol used for device automation and remote access.
Q	Pump flow or flow rate.
RTU	Remote Terminal Unit.
RS-485	Multi drop serial network wiring, used to transfer Modbus data.

For Modbus or BACnet use, this manual assumes that the reader is familiar with commissioning and configuring of Modbus devices. It is also assumed that an existing Modbus or BACnet RTU network on RS-485 wiring with Modbus or BACnet master is present.

For Ethernet and web interface use, this manual assumes that the reader knows how to configure or already has preconfigured Ethernet network.

NOTE:

- Data in this document are subject to change.
- Always verify that the pump is operating as desired after setup is complete.
- Manufacturer cannot be held responsible for problems caused either directly or indirectly by the use of information in this manual.

2. INTRODUCTION

This manual is broken down into two sections and describes the installation, operation and control module for VR15 through VR 30 Low, Medium and High head range of pumps. Section 1 describes the installation and operation features. Section 2 describes the control module and its functions.

Section 1. Installation & Operation

3. GENERAL INFORMATION, USES:

The 00e VR 15 - VR30 circulating pumps are used for the transfer of liquid media within a closed-looped hot-water heating or air-conditioning hydronic system. They are designed as single or parallel main/standby operation variable speed pumps, where the speed is regulated by an on-board electronic device. They are to be used with a water or glycol/water mixture.

4. SAFETY:

These instructions should be studied carefully before installing or operating the pump. They are meant to help you with installation, use and maintenance and to increase your safety. Installation should be performed with regards to local or national standards. Only qualified personnel should maintain and service these products. Failure to comply with safety precautions could cause personal injury or machinery damage.



WARNING: Do not use in swimming pool or spa areas. Pump has not been investigated for these applications.
AVERTISSEMENT: Ne pas utiliser dans une piscine ou un spa. La pompe n'a pas été étudiée pour ces applications.



WARNING: To avoid electrical shock, disconnect the power supply to the circulator and the main electrical unit. Follow all local electrical and plumbing codes.
AVERTISSEMENT: Pour éviter tout choc électrique, débranchez l'alimentation électrique vers le circulateur et l'unité électrique principale. Respectez tous les codes de plomberie et électriques locaux.



WARNING: Hot surfaces can cause burns. The motor can also reach temperatures that could cause injury.
AVERTISSEMENT: Les surfaces chaudes peuvent provoquer des brûlures. Le moteur peut également atteindre des températures qui peuvent entraîner des blessures.



CAUTION: The addition of petroleum based fluids or certain chemical additives to systems using TACO equipment voids the warranty.
ATTENTION: L'ajout de liquides à base de pétrole ou de certains additifs chimiques à des systèmes utilisant un équipement TACO annule la garantie.



CAUTION: Use supply wires suitable for 90°C. ATTENTION: Employer des fils d'alimentation adéquats pour 90°C.



CAUTION: Misconnection or overload of electrical or signal connections could cause pump to shutdown or cause permanent damage.
ATTENTION: Toute erreur de raccordement ou surcharge des connexions électriques ou de signalisation peut entraîner un arrêt de la pompe ou des dommages permanents.



CAUTION: Do not operate pump without the electrical cover securely attached.
ATTENTION: Ne pas actionner la pompe si le couvercle électrique n'est pas correctement fixé.



CAUTION: Pump motor, electronics enclosure and condensate drain openings should not be thermally insulated as it could interfere with cooling and condensate drainage.
ATTENTION: Le moteur de pompe, l'enceinte électronique et les ouvertures de drainage de condensat doivent être thermiquement isolés car il peut y avoir interférence avec l'évacuation de condensat et de liquide de refroidissement.

5. PUMP DESCRIPTION

The high efficiency, electronically commutated 00e VR15 - 30 model pumps consist of two main parts, the centrifugal pump and the electronic control. The hydraulic part is hermetically sealed from the motor assembly and has no mechanical seals. 00e pumps are powered by an electronically commutated permanent magnet motor (ECM) which does not consume energy to magnetize the rotor, providing superior energy efficiency. The ECM is controlled by an on-board frequency converter. The converter estimates current flow and head from the motor load, information essential for self-sensing system reactive operation.

6. USE

All Taco 00e VR pumps are intended for circulation of solid-free fluid in pressurized, hot and chilled hydronic systems. The self-sensing ECM pump constantly calculates pressure and flow, and adapts its speed to the appropriate flow. Stainless steel models are intended for potable drinking water applications and can be used for HVAC systems as well.

7. PUMPED FLUIDS:

Use water and water/glycol mixtures only. Water/glycol mixtures must be HVAC-system compatible and should have no more than 50% concentration of glycol. Excessive glycol concentrations may lead to reduced performance. The fluid shall not consist of aggressive or explosive additives and mixtures of mineral oils and solid or fibrous particles. The pump should not be used for pumping flammable, explosive fluids, and in an explosive environment. To reduce potential abrasive damage a magnetic iron removal device is recommended to remove excessive iron-oxide from the system fluid.

8. PUMP INSTALLATION:

The 00e® pump is protected with a double box packaging during shipping. It can be lifted from the box with internal handles or by lifting it by the heat sink. The included insulation shell reduces thermal energy loss to the surrounding environment and protects the pump from shipping damage.



CAUTION: Pump may be heavy. Provide yourself help if needed.
ATTENTION: La pompe est lourde. Veuillez à demander de l'aide si nécessaire.

Pumps are designed to be installed using standard ANSI class 125 flanges. It is recommended that the 00e pumps be installed with at least 5 to 10 pipe diameters of straight pipe on the inlet and outlet of the pump. Use all nuts and bolts to attach companion flanges to the pump flanges.

All VR model pumps should be installed with the motor shaft axis in a horizontal position (see Figure 1). Failure to do so may result in excessive noise and vibration, premature bearing failure and may void warranty.

Desired pump orientation can be achieved by rotating the pump casing. The pump is mounted to the volute with four screws. By unscrewing those the head can be turned. See detailed Motor Rotation Procedure 8.1 below.

Caution: When reassembling, care should be taken to avoid damaging the o-ring and insuring a tight seal

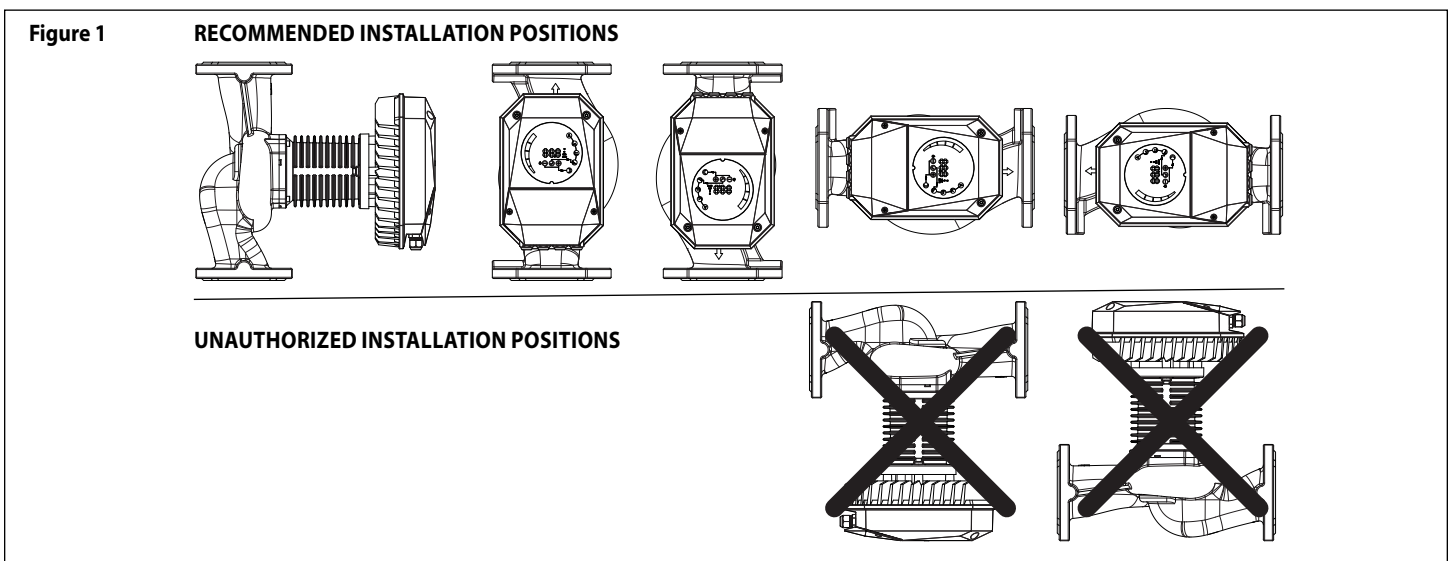

ATTENTION!! Installing pumps in UNAUTHORIZED positions will result in voiding the warranty.

For replacement O-Rings please consult Repair Parts List.

Flange Bolt Sizes		PUMP		CLASS 120 ANSI FLANGE		
Model/Flange Size	Bolt Hole Diameter	Flange Thickness	Bolt Hole Diameter	Flange Thickness	Min. Bolt Size	Qty.
VR15 (1-1/2")	0.63	0.715	0.62	0.688	1/2" x 2-1/8"	4
VR20 (2")	0.75	0.76	0.75	0.75	5/8" x 2-3/16"	4
VR25 (2-1/2")	0.75	0.76	0.75	0.875	5/8" x 2-3/16"	4
VR30 (3")	0.75	0.84	0.75	0.938	5/8" x 2-1/2"	4

Model /Flange Size	Ambient Temperature [°F]	Fluid Temperature		Ambient Temperature [°C]	Fluid Temperature	
		Min. [°F]	Max. [°F]		Min. [°C]	Max. [°C]
VR15 (1-1/2")	Up to 77	36	230	Up to 25	2	110
VR20 (2")	86	36	212	30	2	100
VR25 (2-1/2")	95	36	203	35	2	90
VR30 (3")	104	36	175	40	2	80

ATTENTION: Operation outside recommended conditions may shorten pump lifetime and void the warranty.

8.1 Motor Rotation Procedure Caution: Motor is heavy!

Caution: If system is filled and pressurized, shut off valve before and after the OOE. Allow to cool if system fluid is hot.

8.1.1 Motor Rotation Procedure

The factory default orientation of the Volute and Frequency Drive has the bottom of the VFD and the pump inlet at the 6:00 position, motor shaft horizontal. The following is the procedure the VFD needs to be rotated.

IMPORTANT NOTE: It is highly recommended motor rotation occurs prior to installing. If the pump is installed, rotate prior to filling and pressurizing. If the pump is installed and the system filled / pressurized prior to rotating, system fluid will leak out of the motor/volute when the allen screws are removed.

Ensure the pump is bled of fluid prior to rotating, then purged of air prior to powering back up.

- In a cross pattern, loosen and remove the 4 allen screws holding the motor to the volute.
- With your hands, rotate the motor to the desired position. In the event the motor will not rotate, using a flat bladed screwdriver slightly loosen the motor, then rotate. If all else fails completely remove the motor and reinstall in the desired configuration.
- Ensure the Volute O-Ring is placed in the volute, between the rotor assembly and the volute.
- In a cross pattern, tighten the 4 allen screws.
- Recommended to test run prior to filling and pressurizing system (an E10 Low Load / Dry Run error will occur after 20 to 30 seconds of dry running – temporarily dry running will NOT damage the pump). If an E11, E24 occurs remove the motor and inspect the impeller for evidence of binding in the volute. Re-align, reassemble and re-test.

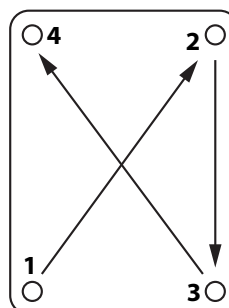

8.1.2 After Installation into piping

- Carefully open shutoff valves and check for leaks.
- Make sure that the electrical box cover is mounted and that all cable glands are installed to prevent dust and particles from contaminating the electrical box.
- Before starting the pump, the system (and pump) must be filled with fluid, and air completely bled out of the system. For proper operation, pressure must be maintained on the suction side of the pump. The pump does not have screws for bleeding the air, as it is automatically bled as a function of the design of the pump. Temporary air in the pump will generate noise that disappears after a short time.
- Extended periods of dry running will activate an E10 low motor load error and in most cases reduce or eliminate sleeve bearing damage caused by dry run conditions

WARNING!

- The maximum system pressure is 175 psi (1MPa or 12 Bar)
- The pump must always be filled with system fluid as it is water lubricated and water cooled
- The motor stator openings (condensate drain holes) and stator housing should not be insulated since the thermal insulation may prevent motor cooling and prohibit condensate from escaping from the motor housing when used in high humidity environments where the fluid temperature is below the motor temperature.

9. ELECTRICAL CONNECTIONS

Connection of the pump must comply with local electrical codes and be carried out by qualified personnel. When connecting the pump, the following must be considered:

- Liquid tight power connection required to maintain the Totally Enclosed, IP44 enclosure rating. Use the supplied thread adapter for flexible or armored cable installations.
- Local or national electrical code requirements supersede Taco's specification.
- Install an electrical disconnect to comply with national electrical code.
- Connection of the power supply electrical cable must be done in a manner that ensures it does not contact the motor housing and volute of the device, due to potential high temperatures of both.

The pump has built-in over current fuse protection, temperature protection, and basic overvoltage protection. It does not require additional overload protection devices unless required by local electrical codes. Power supply cabling should be capable of carrying rated power and be properly fused. Grounding connection is essential for safety and should be connected first. Grounding is only meant for pump safety. System piping should be grounded separately.

Wiring Instruction:

The Taco VR Series is rated for use in single phase applications. It is essential wiring is completed by a qualified technician, in accordance with all local codes and regulations. Input voltage ranges as follows:

- 110 to 240 Volt specific to VR15 and VR20, Low and Medium head models
- 200 to 240 Volt specific to VR15 and VR20 High Head models and all VRF 25 and 30 models

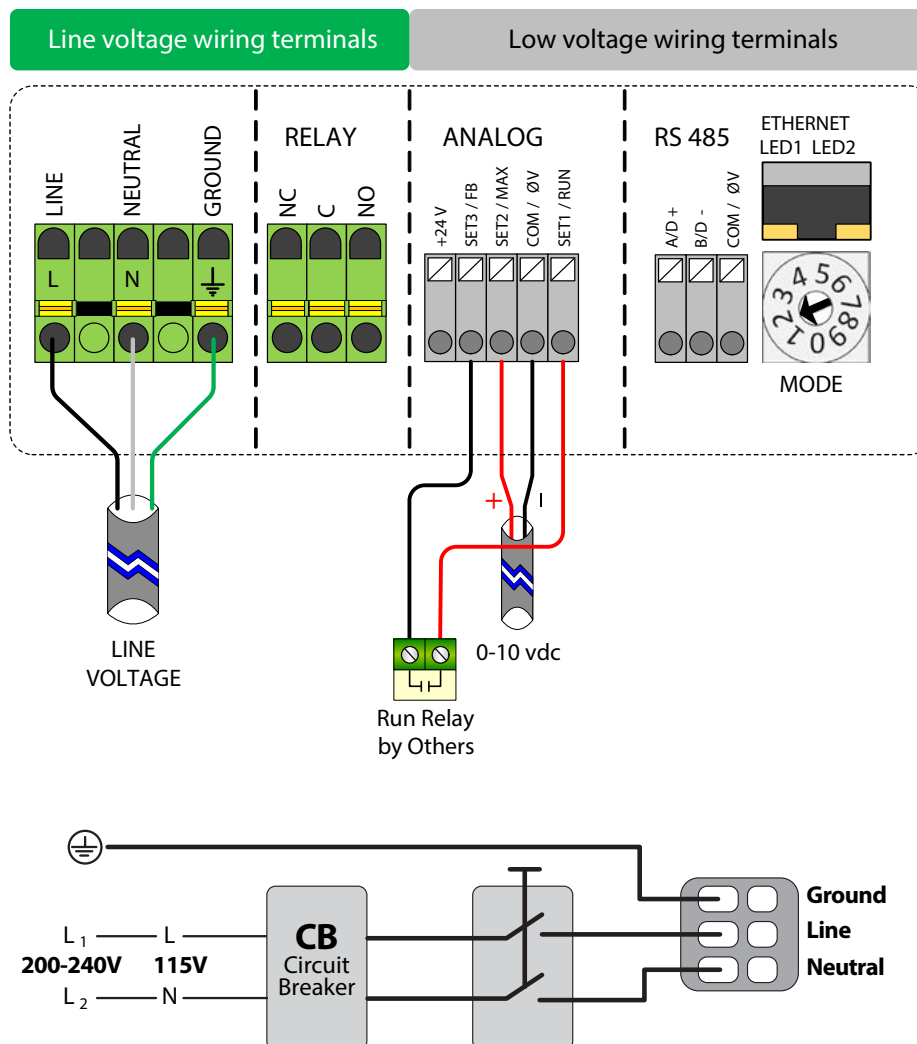

10. SETUP AND OPERATION:

10.1 Control Panel Layout

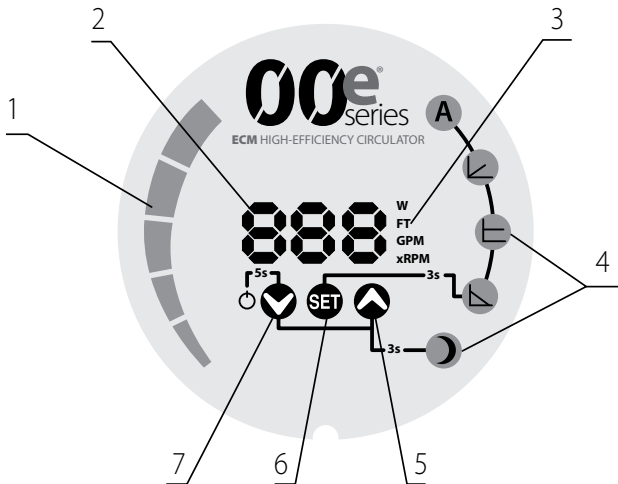

1. Bar Graph of Values
2. Numerical Display of Values
3. Unit Display of the Currently Selected (Watts, Head Setting, Flow, or Speed)
4. Selected Mode (Automatic, Proportional Pressure, Constant Pressure, Constant Speed and Night Setback)
5. [^] Button
6. [SET] Button
7. [v] Button

10.2 Switching the Pump On and Off

When the pump is powered for the first time, it operates with the factory default settings in automatic mode.

To switch the pump off, press and hold the [v] key for 5 seconds, until OFF is shown on the display. When the pump is switched off, the numerical display shows OFF.

To turn the pump on, press the [v] key briefly. Maximum 8 starts per hour (starts meaning power up).

10.3 Pump Functions

[v] Key

Short press:

- Scrolling through parameters downwards, not changing parameter values.
- Scrolling through modes downwards when mode selection is selected.
- Changing parameters downwards when setting parameter values.

Long press:

- 3 seconds together with [^] key to select night setback mode.
- 5 seconds to switch off the pump.
- 5 seconds together with [SET] and [^] keys to restore pump to factory default settings.

[SET] Key

Short press:

- To confirm currently selected values of both mode and parameter.

Long press:

- 3 seconds to enable mode selection.
- 5 seconds together with long press on [^] and [v] keys to restore pump to factory default settings.

[^] Key

Short press:

- Scrolling through parameters upwards, not changing parameter values.
- Scrolling
- Changing

Long press:

- 3 seconds together with [▼] key to enable night setback mode,
- 5 seconds together with [SET] and [▼] keys to restore pump to factory default settings.

10.4 Operation and Mode Selection

Once the desired mode is selected, the factory default parameter is displayed numerical display (except for activeADAPT®). If required, the parameter value can be changed with the [^] or [▼] key, then confirm the parameter setting by pressing the [SET] key. To activate or deactivate the night setback feature, simultaneously press and hold the [^] and [▼] keys for 3 seconds.

To scroll through the parameter values within a mode

10.5 Mode Descriptions

The pump can operate in 5 different modes. We can set the pump in the most appropriate mode, depending on the system where the pump operates.

The pump modes are:

- activeADAPT® (factory default)
- Proportional Pressure (increased differential head as flow increases)
- Constant Pressure (constant pressure as flow increases)
- Constant Speed (user adjustable to match system requirements)
- Combined Mode (all mode indicators are off)

To switch between modes (except night mode) press and hold the [SET] key for 3 seconds then select [^] and [▼] key.

Once desired mode is selected, press the [SET] key to confirm.

activeADAPT® — Factory Default

In activeADAPT mode the pump automatically sets the operating pressure, depending on the hydraulic system. By doing so, the pump finds the optimal operating position. The parameters cannot be set; they can only be scrolled through. This mode is recommended in most systems.

Proportional Pressure

The pump maintains the pressure with relation to the current flow. The pressure is equal to the set pressure (Hset on the drawing) at maximum power; at 0 flow it is equal to HQ % (default 50%, HQ % can be set on the pump webpage) of the set pressure. In between, the pressure changes linearly, relative to the flow. In regulated mode we can only set the pump pressure (Hset on the drawing). We can only scroll through the other parameters.

We can only scroll through the other parameters.

Constant Pressure

The pump maintains the currently set pressure (Hset on the drawing), from 0 flow to maximum power, where the pressure begins to drop. At constant pressure, we can only set the pressure (Hset on the drawing) which the pump will maintain. We can only scroll through the other parameters.

Constant Speed

In constant speed (fixed speed), the pump operates with the currently set speed (RPMset on the drawing). In the unregulated mode, we can only set the speed at which the pump will operate. We can only scroll through the other parameters.

Combined Mode

Multiple limits can be set only over the web interface. None of the other modes are on.

Night Mode

When the pump operates in night mode, it automatically switches between the selected operating mode and the night curve. The transition to the night mode depends on the fluid temperature in the system. When the night mode is enabled, its icon illuminates and the pump operates in the selected operating curve of the mode. When the pump identifies the media temperature falling by 60 to 70°F (15-20°C) over a 2 hour time period, the icon starts to blink and the pump switches to the night curve. When the fluid temperature rises again, the icon stops blinking and the pump switches to the operating curve in the selected operating mode. The night mode operates only in combination with the above indicated modes. It is not an independent mode.

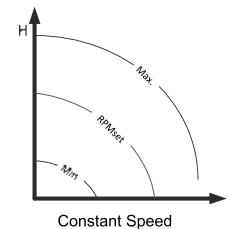
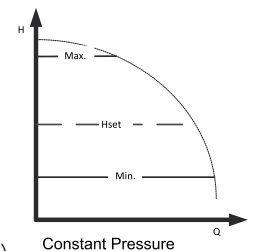
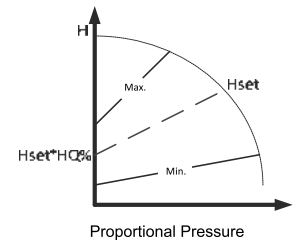

10.6 Restoring Factory Settings

To restore factory defaults, press and hold all three buttons for 5 seconds. The pump will be set to the activeADAPT® mode of operation. Any previously set values for pressure and RPM will be deleted.

10.7 Minimum Speed Adjustment

1. Connect to the pump HTML Web Page
2. Open "Pump" Tab (see below)
 - i. Min Setpoint dropdown window
 1. Adjustable between 10% and 100% of full speed in 10% increments
 2. Select a % for minimum speed to achieve preferred minimum flow (refer to Overview Tab for flow – see below)
 3. CLICK SAVE!
 4. If min flow needs to be increased, go back to the pump tab and increase setpoint %, click save and note change flow in the Overview Tab.

The screenshot displays the 'Pump' configuration page with a navigation bar at the top containing 'Overview', 'Pump', 'Network', 'Log', and 'More'. The 'Pump' tab is active.

Pump configuration

Op. mode will configure pump operation mode.
"OFF" will stop the pump.
"AUTO PRESSURE" will try to reduce pressure according to system.
"PROPORTIONAL PRESSURE" will keep head under "Max head" and then reduce it up to 50% at low flow.
"CONSTANT PRESSURE" will keep head at "Max head".
"CONSTANT SPEED" will keep pump speed at "Max RPM".
"COMBINED MODE" will use "Max head", "Max RPM" and "Qprop" as upper limits.

Night mode will reduce pump speed if fluid temperature drops rapidly (at night heat reduction).

Pump configuration

Op. mode: CONSTANT SPEED ▼
Max head: 42.0 ▼ ft H2O
Max RPM: 2800 ▼ rpm
Qprop: 50 ▼ %
Night mode:

Control configuration

Mode switch: 1
Min setpoint: 10 ▼ %
SET 1 function: RUN input 2-3V ▼
SET 2 function: MAX input 2-10V ▼
SET 3 function: FB output 10.5V ▼
Relay function: PUMP READY ▼

Save all

Save

10.8 Parallel Pump Instructions

10.8.1 Twin Pump Function: The VR Series Parallel Pump Function enables the communication between two pumps when piped in parallel, without the use of additional control devices. Parallel pump control requires both pumps connected via a CROSSOVER Ethernet cable. The installation of a check valve is required on the discharge side of each pump, installed at least 10 pipe diameters from the pump discharge. Failure to install check valves will cause reverse flow through the off pump and may damage the electronics and cause lower than required system flow.

- 1.1 Automatic Alternation: To ensure equal run times the pumps are alternated every 24 run time hours. The alternation hour period is not adjustable.
- 1.2 Back-up Operation: If the operating pump experiences an overload condition (**See Section 19**) an enable (run) signal is sent to the back-up pump. The back-up will remain active until the cause of the overload is corrected.
- 1.3 Cascade Operation: If the flow demand exceeds the maximum flow of the operating pump a run signal is sent to enable the off pump, running both pumps at the same time. The pump system returns to single pump operation as the flow demand drops. It is **IMPORTANT** both pumps are the same model and have the same settings and are **NOT** set on activeADAPT mode.

10.8.2 Parallel Pump Set-up:

- 2.1 To enable the Twin Pump Function – IP Address setting requirements...
 - 2.1.1 Lead Pump:
 - Main IP Address (default) 192.168.0.245
 - Twin Pump IP Address 192.168.0.246
 - 2.1.2 Lag Pump:
 - Main Pump IP Address 192.168.0.246
 - Twin Pump IP Address 192.168.0.245
 - 2.1.3 Setting Lag Pump IP Address via Mode Dial:
 - 2.1.4 Set Mode dial to 8
 - 2.1.5 Perform a hard reset (cycle main power off, wait for 30 seconds and power on)
 - 2.1.6 Set Mode back to prior Mode (default Mode 1)
 - 2.1.7 Perform a hard reset
 - 2.1.8 **IMPORTANT!** After this change, when connecting to the Lag Pump via laptop use the new IP Address 192.168.0.246

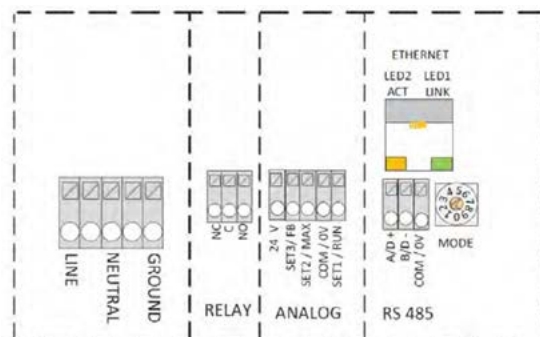

- 2.2 Setting Lag Pump IP Address via HTML page
 - 2.2.1 Connect Laptop with standard Ethernet cable
 - 2.2.2 Enter IP Address 192.168.0.245 in any Internet browser
(you do not need to connect to the internet)
 - 2.2.3 Once connected, navigate to the Network tab – make IP Address changes for Lag pump
 - 2.2.4 CLICK SAVE

10.8.3 Confirm Pump to Pump Communication

- 3.1 Connect both pumps via CROSSOVER Ethernet cable
- 3.2 Ensure both pumps are powered
- 3.3 Observe the Ethernet RJ-45 port's LEDs on both pumps
 - 3.3.1 LED1 LINK: Slowly blinking when electronics powered, permanently lit when communication established
 - 3.3.2 LED2 ACT: Indicated Ethernet or RS-485 activity
- 3.4 Optional confirmation of Pump to Pump communication
 - 3.4.1 Power both pumps
 - 3.4.2 Connect the CROSSOVER Ethernet cable
 - 3.4.3 One of the pumps should run, the other should be in standby
 - 3.4.4 Power off the running pump. After 10 to 15 seconds the standby pump should come on
- 3.5 IMPORTANT Ethernet cable installation recommendation
 - 3.5.1 Due to the enclosure rating an Ethernet RJ-45 cable end will typically not fit through the drive cover opening consequently the RJ-45 connector should be fitted to the Crossover Ethernet cable after it is fed through the drive cover opening.

11.1 Application:

- Maximum Operating Pressure: 175 PSI (12 bar)
- Water Temperature Range: 36° – 230°F (2.2° – 110°C)
- Ambient Operation Temperature Range: 32° – 104°F (0° – 40°C).
Ambient temperature should be 104°F (40°C) or lower when fluid temperature exceeds 194°F (90°C).
- Relative Humidity: Max. 95%
- Designed for closed loop heating and cooling systems pumping water or a water/glycol mixture.
- NPSHr - Minimum static inlet .pressure (absolute) at pump suction to avoid damage to the bearing assembly:

Fluid Temperatures	VR15 & VR20	VR25 & VR30
112°F (50°C)	7.3 PSIA / 0.5 Bar	4.36 PSIA / 0.3 Bar
176°F (80°C)	11.6 PSIA / 0.8 Bar	14.5 PSIA / 1.0 Bar
230°F (110°C)	20.3 PSIA / 1.4 Bar	20.3 PSIA / 1.4 Bar

- For indoor use only - employer uniquement a l'intérieur.

11.2 Electrical Ratings:

Model	VR15L	VR15M	VR15H	VR20L	VR20M	VR20H	VR25L	VR25M	VR25H	VR30L	VR30M	VR30H
Input Voltage All single phase, 47 To 63 Hz)	110/240	110/240	200/240	110/240	110/240	200/240	200/240	200/240	200/240	200/240	200/240	200/240
Max Power (HP)	0.37	0.65	0.91	0.5	0.75	1.1	0.75	1.1	2.1	1.1	1.9	2.1
Max Power (W)	270	480	680	370	560	820	560	810	1550	800	1380	1550
Rated Current (A)	1.2	2.1	2.9	1.7	2.4	3.6	2.5	3.5	6.6	3.5	6	6.6
Current Limit (Max) (A)	6	6	6	6	6	6	6	6	8	6	8	8
24V Supply Output	Max current up to 100 mA, Output voltage of 24V +/- 20%, Output ripple under 1V											
Relay Output	8A, Maximum Voltage 250 VAC, 48 VDC, Load up to 500 VA											
Digital Inputs	Maximum Input Voltage: 32VDC											
	2 Inputs, 1 output											
	Logical»1«Voltage> 8V,Logical»0«Voltage< 2V											
Ethernet	RJ-45 Connector											
	Services: http server and client, FTP server											

11.3 Standards, Protection and Connection:

- Insulation: Class H
- Enclosure: Class 2, IP44
- Integrated Motor Protection (electronically protected)
- Continuous Duty
- UL778,1004-1,508C
- CAN/CSA C22.2 #108, #100, #107.1 EMC(89/366EEC):EN61000
- LVD(73/23/EC):EN60335-1,EN60335-2-51
- Machine Safety(98/37/EC): EN ISO 12100
- Flange Connections: Class 125/150 ANSI 4-bolt

11.4 Materials of Construction:

Casing (F Models).....Cast Iron, Cathaphoresis Coated
Casing (SF Models).....304 Stainless Steel
ImpellerPES GF-30
ShaftSteel ANSI 420
Bearing.....Carbon

Section 2. Controller (VFD) Operation

12. FEATURES

This section describes the controller features for VR 15 through 30 L, M & H range of pumps. The controller is used for various remote control applications, including:

- Remote on/off
- Analog 0-10Vdc or PWM control
- BACnet and Modbus remote control
- Status relay feedback
- Web access over Ethernet

There are several multiple connection configurations. Not all functions can be used simultaneously.

- on/off + 0..10 V + relay output
- Modbus & BACnet RTU + Relay output
- Ethernet + on/off + 0..10
- Modbus & BACnet RTU + Ethernet
- Ethernet + on/off + relay output



12.1 Specifications

Below is an overview of Controller specifications. For details, please refer to appropriate sections of this manual.

General Data		
Ambient humidity	< 95 % relative, non-condensing	Also see appropriate pump data for other ambient specifications.
Power supply and connection	5 V@500 mA supplied by the pump	6-pin connector further extended for display.

BACNET SPECIFICATIONS • 12.2		
Baud Rate	38400 (default)	
MAC Address	45 (default)	
Device Instance	12345 (default)	
Network IP	192.168.0.245 (default)	
MAC	02:01:36:BF:42:AD (default)	
Gateway	192.168.0.1	

MODBUS SPECIFICATIONS • 12.3		
Data protocol	Modbus Remote Terminal Unit (RTU)	---
Modbus connector	Screw-less terminals	2+1 pins. See section 16.3 "Connection to Modbus"
Modbus connection type	RS-485	---
Modbus wire configuration	Two-wire + common	Conductors: A, B and COM (Common). See section 16.3 "Connection to Modbus".
Communication transceiver	Integrated, 1/8 of standard load	Connect either via passive taps or daisy chain.
Maximum cable length	1200 m	See section 16.5 "Termination".
Lag (Secondary) Pump address	1-247	Default is 245, settable over Modbus. See section 16.4 "Speed, parity and address".
Line termination	Not present	Line termination is not integrated. For low speed/short distance, termination can be omitted. Otherwise, terminate the line externally on both ends.
Supported transmission speeds	1200, 2400, 4800, 9600, 19200, 38400 baud	Settable over Modbus register [default=19200].
Start bit	1	Fixed.
Data bits	8	Fixed.
Stop bits	1 or 2	1 stop bit minimum, up to 2 when parity not enabled [default=1]
Parity bit	Even/odd/none	[default=Even]
Modbus visual diagnostics	LED2	Flashing yellow when data reception detected. Combined (OR) with Ethernet ACT function.
Max. number of Modbus devices	247	Limited by possible Modbus addresses to 247. 1/8 nominal load enables 256 devices.
Max. Modbus packet size	256 bytes	Including address (1) and CRC (2) bytes.
Isolation	Common ground (COM) with SET1, SET2 and SET3.	Modbus shares common ground with other signals.

ETHERNET SPECIFICATIONS • 12.4		
Ethernet connector	RJ-45	10BASE-T, 10Mbit/s connection.
Connection type and services	<ul style="list-style-type: none"> - Web server (port 80) - Firmware update over web interface - Optional Modbus RTU over TCP/IP 	
Default IP address	192.168.0.245	192.168.0.246 for right twin pump.
Ethernet visual diagnostics	LED1 / LINK	Slowly blinking when module is powered, permanently lid when link established.
	LED2 / ACT	Flashing yellow when data reception detected. Combined (OR) with Modbus data reception indication.

MODE SELECTION SWITCH		
Adjustment	10 position rotary switch	Position read at power-on. Used for relay configuration and module configuration reset.

Analog Signals (SET1, SET2, SET3) • 12.5		
Input Voltage Range	-1 to 32 VDC	When used as input.
Output Voltage Range	0 to 12 V	When used as output. 5 mA max. Load allowed per output.
Input Resistance	~100 kΩ	0.5 mA load is added for most configurations.
---	---	Current sink to COM if configured as output.

Relay Specifications • 12.6		
Connection Type	Screw-less terminals	
Rating	- 250 VAC, 8A	Potential free changeover contact.
	- 48VDC, Max Load up to 500VA	

13 Controller Layout

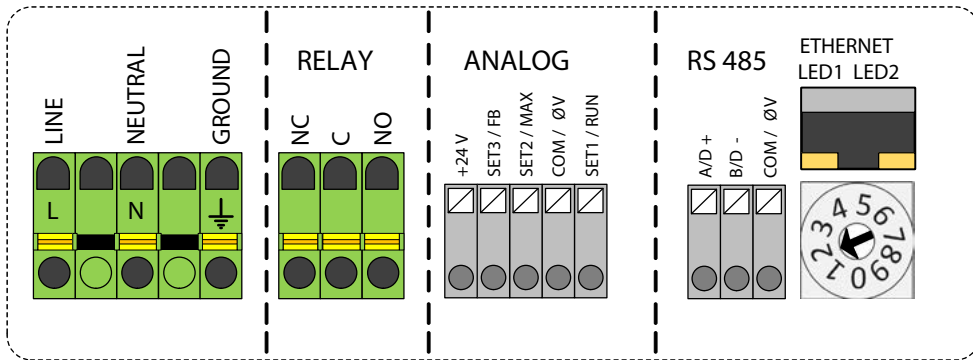

VR 25H, VR 30M and VR30H controller

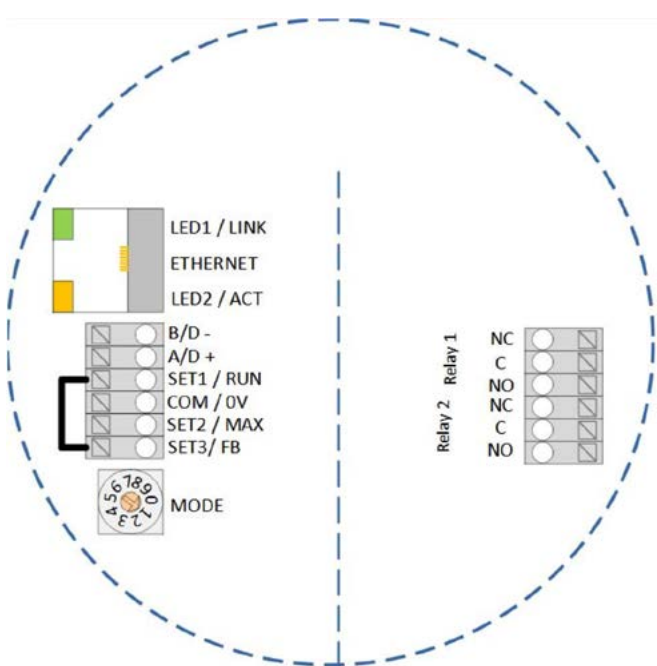

All models except VR25H, VR30M and VR30H

Terminal Designation	Description
MODE	Mode selection rotary switch. Used to configure mode of operation for the circuit. See section 14.3 "Module mode selection"
LED1 / LINK	Slowly blinking when module is powered. Blinking fast when Modbus Error. Permanently lid when Ethernet link established.
Ethernet	10BASE-T RJ-45 connector.
LED2 / ACT	Indicates Ethernet activity, Modbus or BACnet activity.
B/D-	RS-485 negative data signal for Modbus or BACnet.
A/D+	RS-485 positive data signal for Modbus or BACnet
SET1 / RUN	Control signal 1.
COM / 0V	RS-485 common and analog input common (ground).
SET2 / MAX	Control signal 2.
SET3 / FB	Control signal 3.
NC	Normally closed relay contact. Opens when relay is active.
C	Relay common contact.
NO / NO	Normally open relay contact. Closes when relay is active.

13.1 Connection Considerations

- All cables connected must be heat-resistant to at least +185 °F.
- All cables connected must be installed in accordance with The National Electric Code / NFPA 79 / EN 60204-1.
- All wires to the communications module must be connected to the terminals or cut. No loose wiring permitted.

WARNING!



- If voltages over 24 VAC/DC are possible on NO, C, NC terminals:
- Wires should be routed so no wire crosses the center barrier.
- Relay cable (NO, C, NC) must be separated from all other wiring with reinforced insulation.
- Cable outer layer must not be stripped longer than 0.59 inches. See “Cabling preparation” below.



WARNING! Before performing any work on the module, make sure that the pump and module electricity supply has been switched off and that it can- not be accidentally switched on.

13.2 Connection Examples

DEFAULT (FACTORY) CONFIGURATION

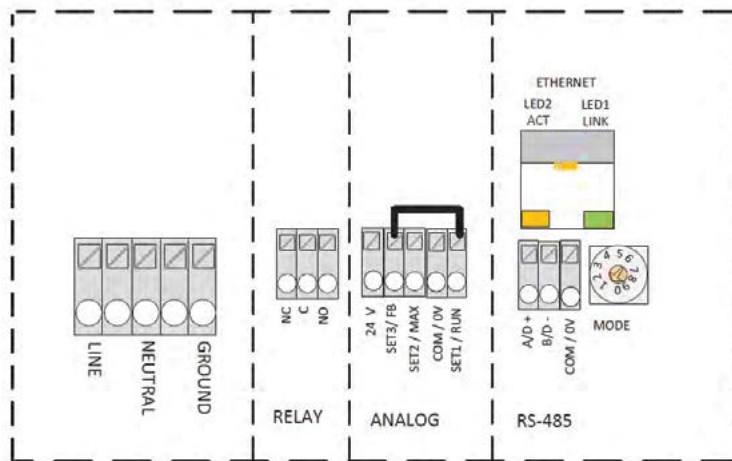

RELAY AND MODBUS CONNECTION

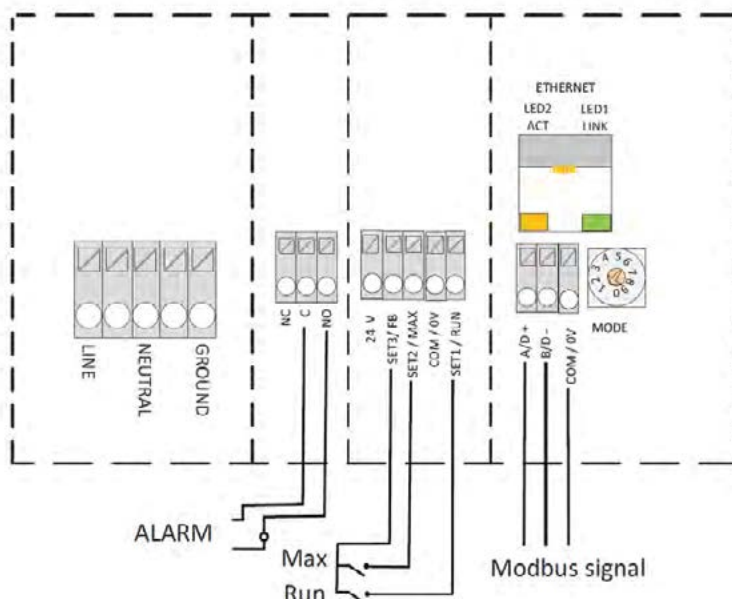

RELAY AND ETHERNET CONNECTION

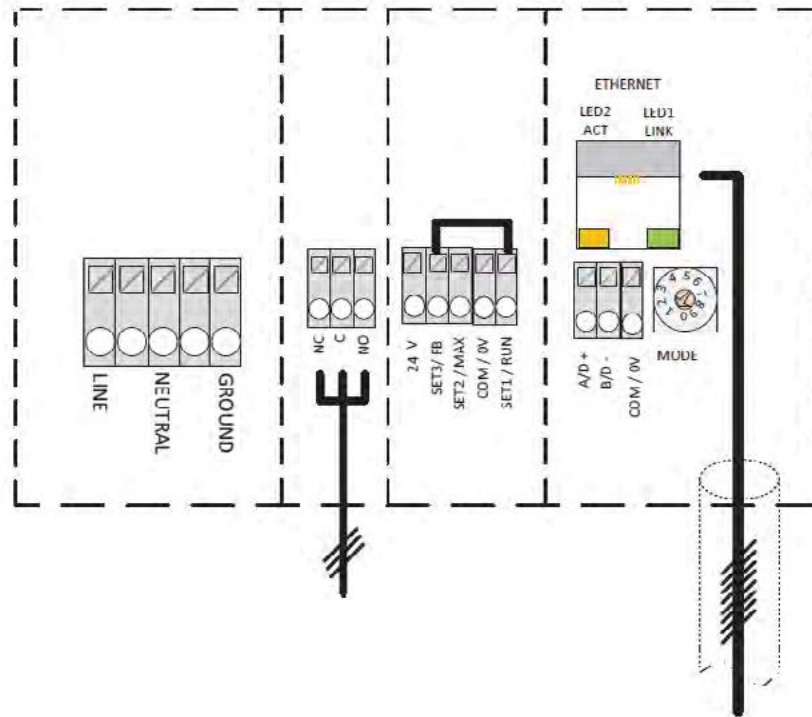

NOTE: 7/8" max length Ethernet connector recommended. The Ethernet connection has a sharp cable bend angle and reducing the connection terminal length reduces this problem.

NOTE: To maintain pump IP protection, the network cable should be pulled through the gland inlet and then crimped to a connector.

14.CONTROL MODES AND PRIORITIES

14.1 Setting Priority

Several signals will influence the pump operation. For this reason, settings have priorities as shown in the table below. If two or more functions are active at the same time, the one with highest priority will take precedence.





Priority	Pump control panel & Ethernet settings	External signals ¹	Modbus control
1	Stop (OFF)	---	---
2	Night mode active ²	---	---
3	Max. RPM (Hi)	---	---
4	---	Min. curve ⁴	---
5	---	Stop (Run not active)	---
6	---	Max. curve ⁴	Stop ³
7	---	Set point setting ⁴	Set point setting ³
8	Set point setting ⁴	---	---

Examples:

- Stop on the pump display panel will stop the pump, regardless of external set point.
- If External Run input is inactive, the pump cannot be started over Modbus, but can be set to max RPM on the display panel.

14.2 Control Variables

Pump will respond to external controls according to selected pump operating mode. Consult proper pump operating manual for explanation.

Symbol	Regulation mode	Module set point controls:
	activeADAPT®	--- (RUN ONLY)
	Proportional pressure	Maximum head
	Constant pressure	Maximum head
	Constant speed	Speed (RPM)
---	Combined ⁵	(Web interface only)
	Night mode ⁶	--- (RUN ONLY)

¹ Not all inputs are available in all modes.

² External, Modbus and BACnet. Stop signals become active in night mode. Due to possible confusion, use of night mode is discouraged while using external control.

³ Only available when pump is bus controlled.

⁴ Not available when pump is bus controlled.

⁵ Multiple limits can be set. Not available on all pumps.

⁶ Night mode is not independent regulation mode.

14.3 Module Mode Selection



WARNING! Before performing any work on the module, make sure that the pump and module electricity supply has been switched off and that it cannot be accidentally switched on.

There is a mode selection rotary switch in the terminal box. It can be rotated by gently inserting a screwdriver into the arrow mark on top and rotating the switch to desired value.

IMPORTANT: Cycle the pump power supply off for 20 seconds after a mode change.

Mode Switch Position	Function	Description
0	Free configuration	Terminal functions are configured over Ethernet interface.
1	Mode 1 Factory Default (2-10Vdc control)	SET1 = RUN input SET2 = MAX input SET3 = FB (10.5 V) output, used to supply RUN and MAX inputs See Section 14.4 "Mode 1"
2	Mode 2 (0-10Vdc control)	SET1 = RUN input SET2 = SPEED input SET3 = FB (10.5 V) output, used to supply RUN and MAX inputs See section 14.5 "Mode 2"
3	Mode 3 (PWM Solar)	SET1 = PWM-in (0 % = Pump OFF) SET2 = PWM-out status SET3 = FB (10.5 V) output, can be used to supply SET1 and SET2
4	Mode 4 (PWM Heating)	SET1 = PWM-in (100 % = Pump OFF) SET2 = PWM-out status SET3 = FB (10.5 V) output, can be used to supply SET1 and SET2
5	RESERVED	Reserved for future or customer specific use.
6	Show relay configuration	LED1 and LED2 will show relay configuration. See section "5 Relay output".
7	Change relay configuration	Relay configuration will be increased (0->1, 1->2, 2->0) when power is turned on. LED1 and LED2 will show current relay configuration. See section "5 Relay output".
8	Twin reset to factory	Same as Mode 9, with exception of: module IP address is set to 192.168.0.246 Twin IP address is set to 192.168.0.245
9	Reset to factory	This mode will set communication interface to default values. Main purpose is to restore default settings. NOTE: <ul style="list-style-type: none"> • Disconnect any SET1, SET1, SET2, SET3 will output test voltages of 10 V, 7 V and 5 V respectively. RS-485 port is actively driven. Relay will cycle. • It is recommended that all module wires are disconnected to prevent possible harm to external controllers









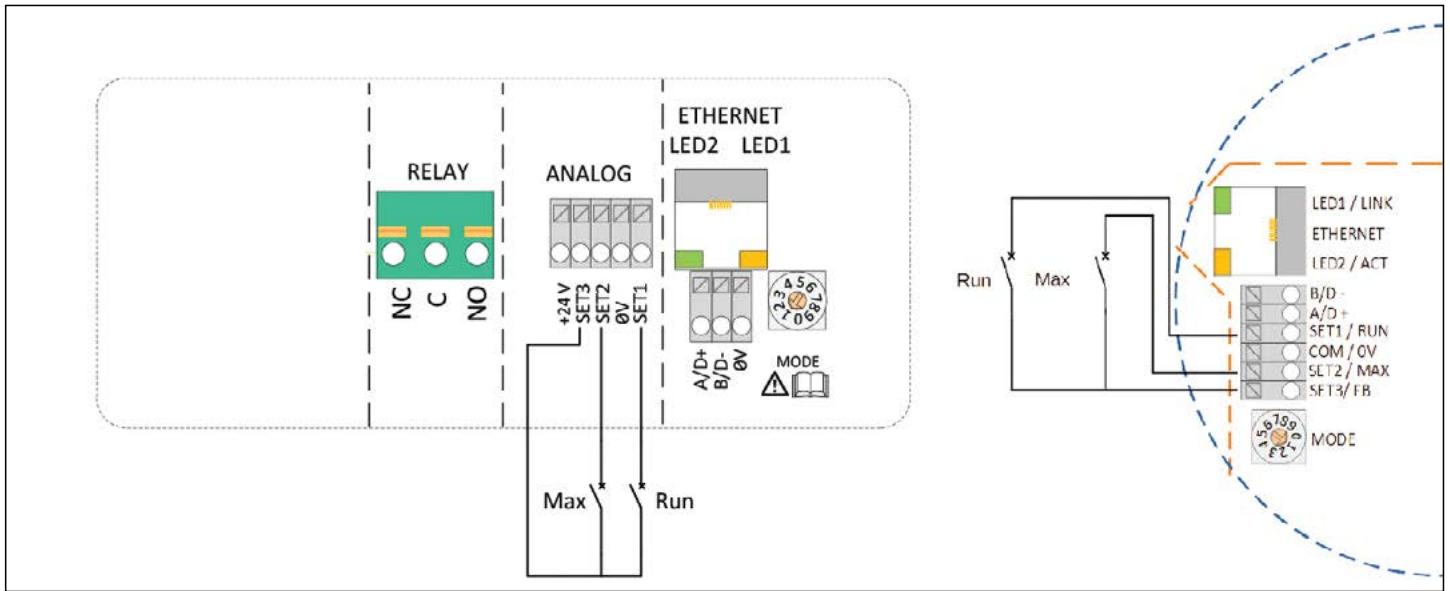

14.4 Mode 1

Digital switched enable / disable (run signal) and digital switched max or min speed. No external speed or head control

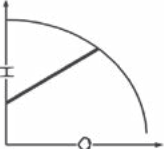
Application:

Using a digital switch to enable or disable the pump and a separate switch to force the pump to max or minimum speed (user selectable)

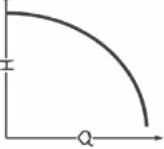

Contact Position		Function	Description
RUN	MAX		
SET 3/FB 	SET 3/FB 	Stop the pump	The pump is stopped
SET 1/RUN 	SET 2/MAX 	Start the pump	The pump will run with internal set point 
		Minimum curve	The pump will run with minimal speed for selected regulation mode 
		Maximum curve	The pump will run with maximum speed form selected regulation mode 

MODE 1 – Digital switched enable / disable (on/off), external analogue 0-10Vdc speed or head control (pump starts on medium speed or head)

Application: Using an external 0-10Vdc signal to control the speed (or head) of the pump and a separate signal to enable/disable the motor. Pump starts and stops on medium speed for pre and post purging.

IMPORTANT:

- Mode value must not be set to MAX or Auto, otherwise changes in the 0-10Vdc signal will not change the pump's performance
- Minimum and maximum speeds can be set via the pump's HTML web page "Pump" configuration tab
- Reverse polarity will not cause damage – The pump will not react to any changes
- 0-10Vdc values can be confirmed on the pumps HTML web page, Overview Tab, Control Signal (See Section 19)

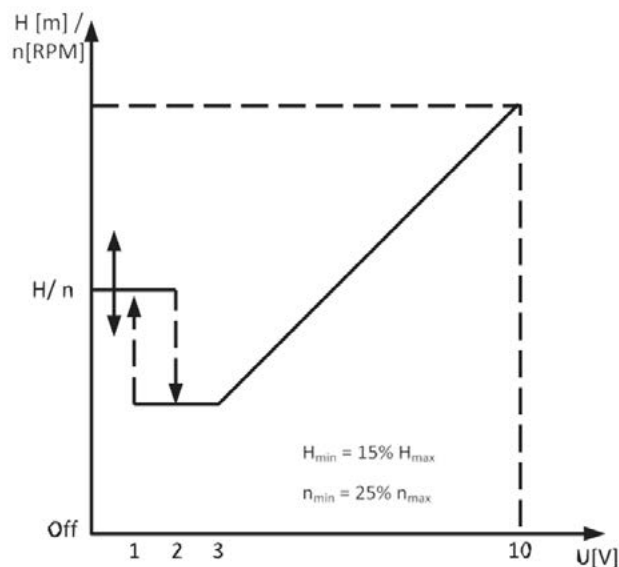
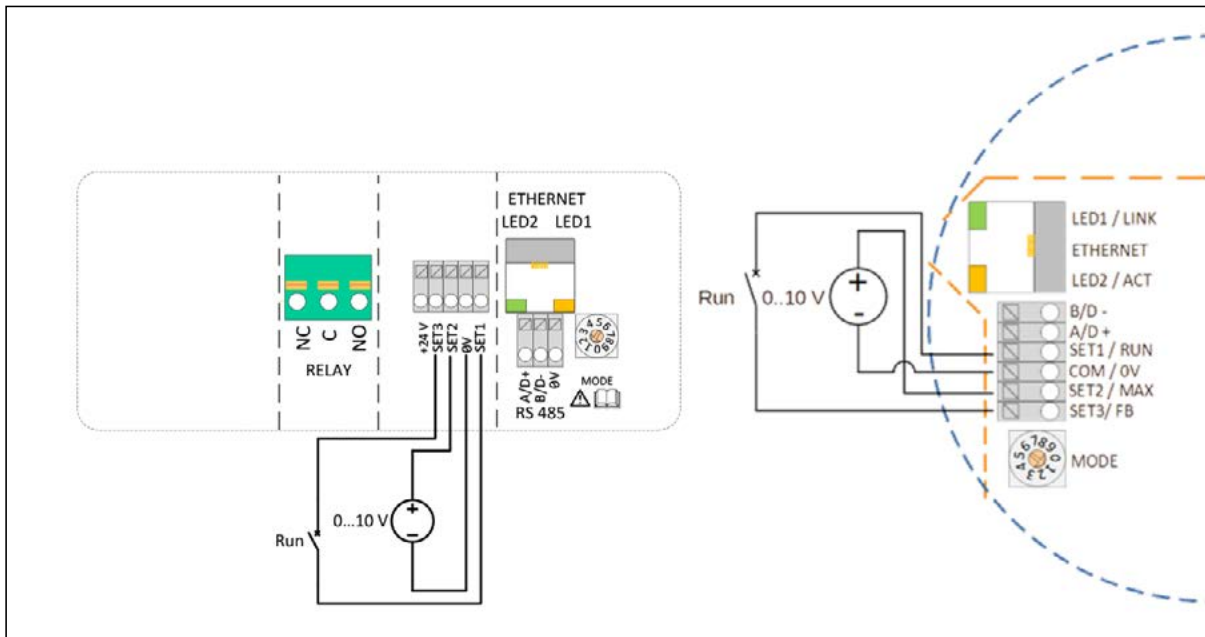

Sequence of Operation:

- Set 3 and Set 1 Open – Pump in Standby (VFD powered, motor is off, no flow), regardless of 0-10Vdc signal
- Set 3 and Set 1 Closed – increasing 0-10Vdc signal
 - 0 to 2 V pump runs at medium speed (pre-purge)
 - 2 to 3 V pump runs at min speed (25% of max speed) or min head (15% of max head)

NOTE: Min speed user adjustable to meet min flow requirements

- 3 to 10 V speed increases linearly to V
- Set 3 and Set 1 Closed – decreasing of 0-10Vdc signal
 - 10 to 3 V speed decreases linearly to V
 - 3 to 1 V pump runs at min speed
 - 1 to 0 V pump runs at med speed (post-purge)

MODE 1 – External analogue 0-10Vdc speed or head control and enable / disable

Application:

Using an external 0-10Vdc signal to control the speed or head of the pump and enable / disable the pump

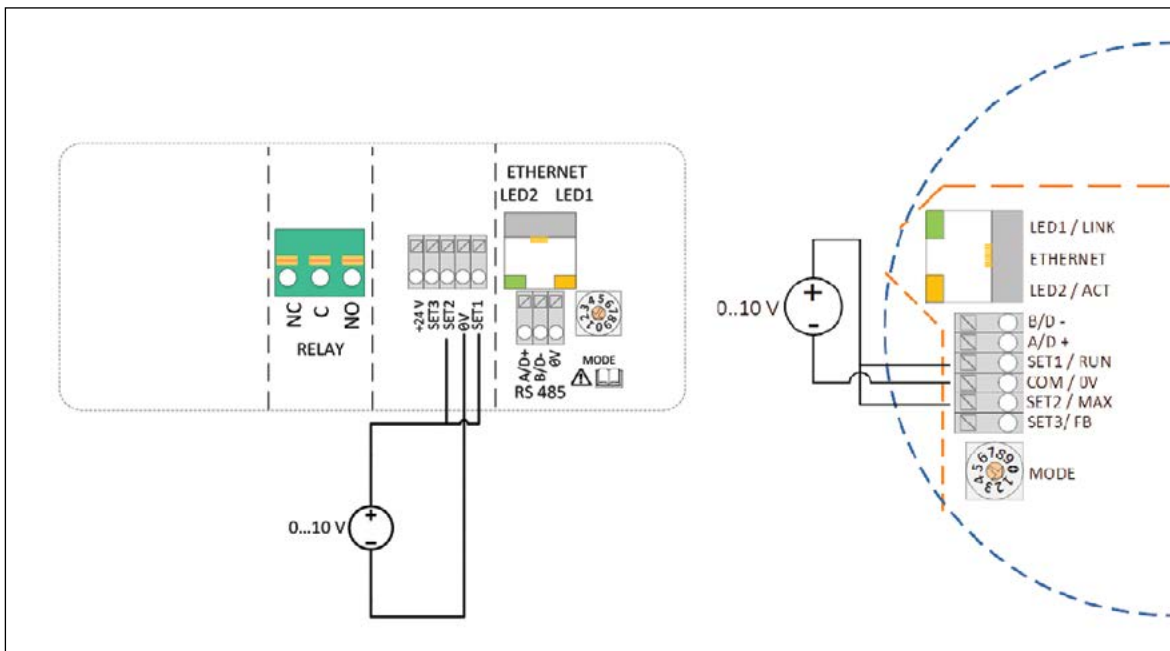

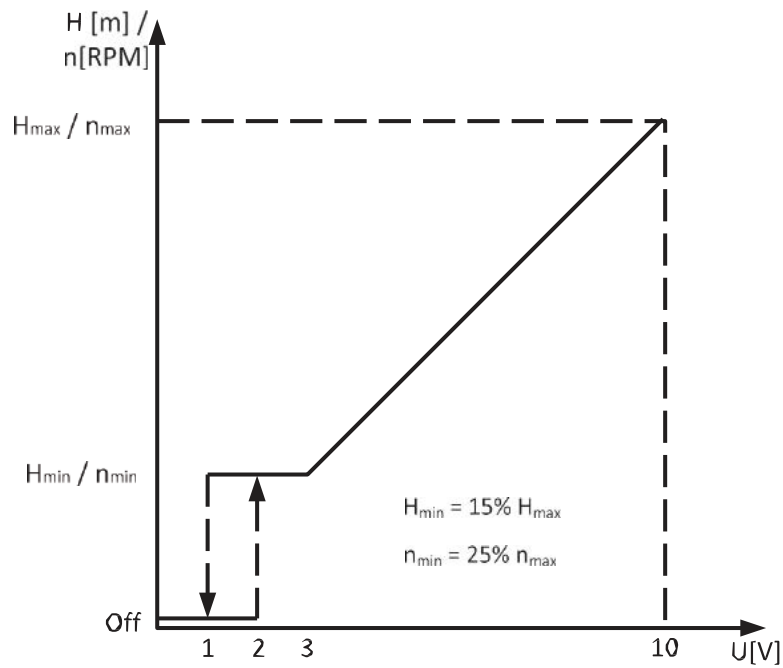

Sequence of Operation:

- Increase of 0-10Vdc signal
 - 0 to 2 V pump off
 - 2 to 3 V pump runs at min speed (25% of max speed) or min head (15% of max head)

NOTE: Min speed user adjustable to meet min flow requirements

- 3 to 10 V speed increases linearly to V

- Decrease of 0-10Vdc signal
 - 10 to 3 V speed decreases linearly to V
 - 3 to 1 V pump runs at min speed
 - 1 to 0 V pump off

14.5 MODE 2 – Digital switched enable / disable, external analogue 0-10Vdc speed or head control

Application:

Using an external 0-10Vdc signal to control the speed or head of the pump and a separate signal to enable/disable the motor. Pump starts on low speed or head.

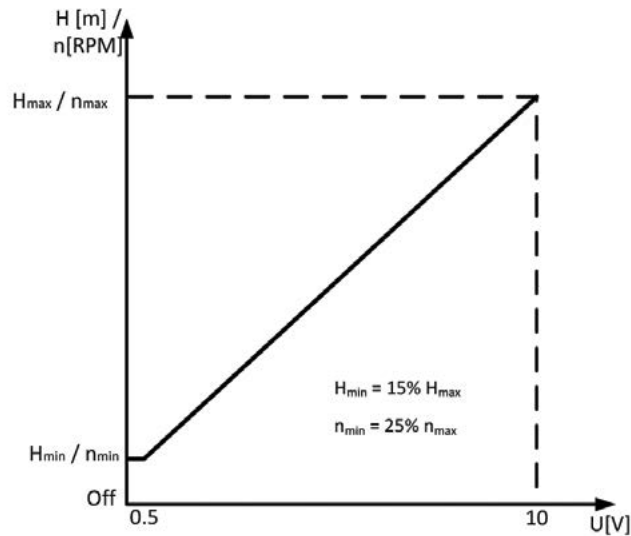
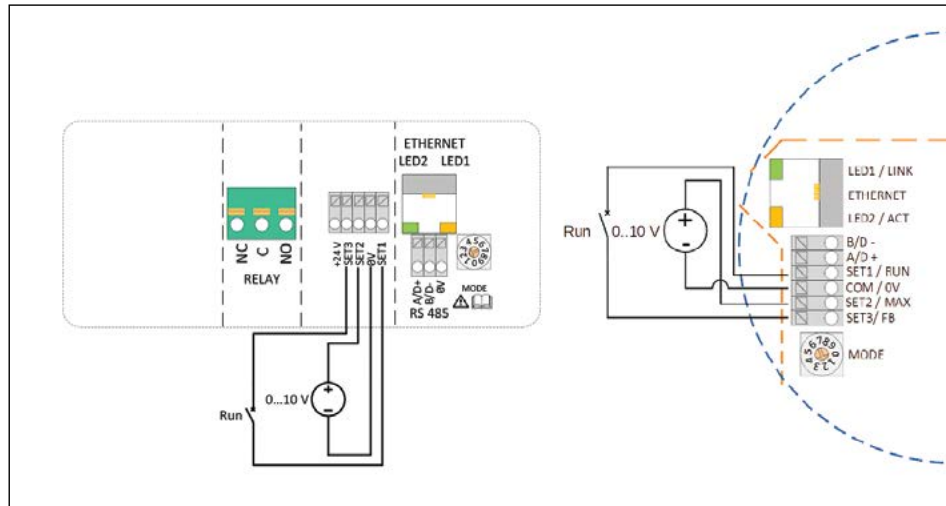

Sequence of Operation:

- Set 3 and Set 1 Open – Pump in Standby (VFD powered, motor is off, no flow), regardless of 0-10Vdc signal
- Set 3 and Set 1 Closed – increasing 0-10Vdc signal
 - 0 to 0.5 V pump runs at min speed (25% of max speed) or min head (15% of max head)

NOTE: Min speed user adjustable to meet min flow requirements

- 0.5 to 10 V speed increases linearly to V

- Set 3 and Set 1 Closed – decreasing of 0-10Vdc signal
 - 10 to 0.5 V speed decreases linearly to V
 - 0.5 to 0 V pump runs at med speed (Standby when Set 3 and Set 1 open)

Summary:

- Enable / disable separate signal from 0-10Vdc
 - Mode 1 – Pump starts and stops on medium speed (or head)
 - Mode 2 – Pump starts and stops on low speed (or head), adjustable
- Enable / disable and 0-10Vdc external control the same signal
 - Mode 1 – Pump starts and stops on minimum speed (or head)

14.6 MODE 3 & 4 – PWM (Pulse Width Modulation) External Speed or Head Control

Modes 3 & 4 are used for PWM control and feedback according to IEC 60469-1.

Mode 3 stops the pump when the signal is 0% or missing, Mode 4 runs the pump at fill power.

Application:

Using an external PWM signal to control the speed or head of the pump.

Enable / disable control using a separate digital signal.

Terminal Designation	Signal Function
SET1 / RUN	PWM-in (PWM input) Signal frequency: 100 Hz – 10000 Hz (1000 Hz nominal) Signal load: 5 mA (4 – 6 mA, internally limited) Signal amplitude: 3.3 – 24 V (threshold at approx. 3V)
COM / 0V	Common ground for signals
SET2 / MAX	PWM-out (PWM output) Signal frequency: 75 Hz (± 1 Hz) Signal drive: Open drain, (100 ohm, 20 mA internal current limit) Signal amplitude: 0 – 24 V Signal polarity: Active high (0% - pulled to COM, 100% -open)
SET3 / FB	FB (10.5 V) output, can be used to supply SET1 and SET2 bias.

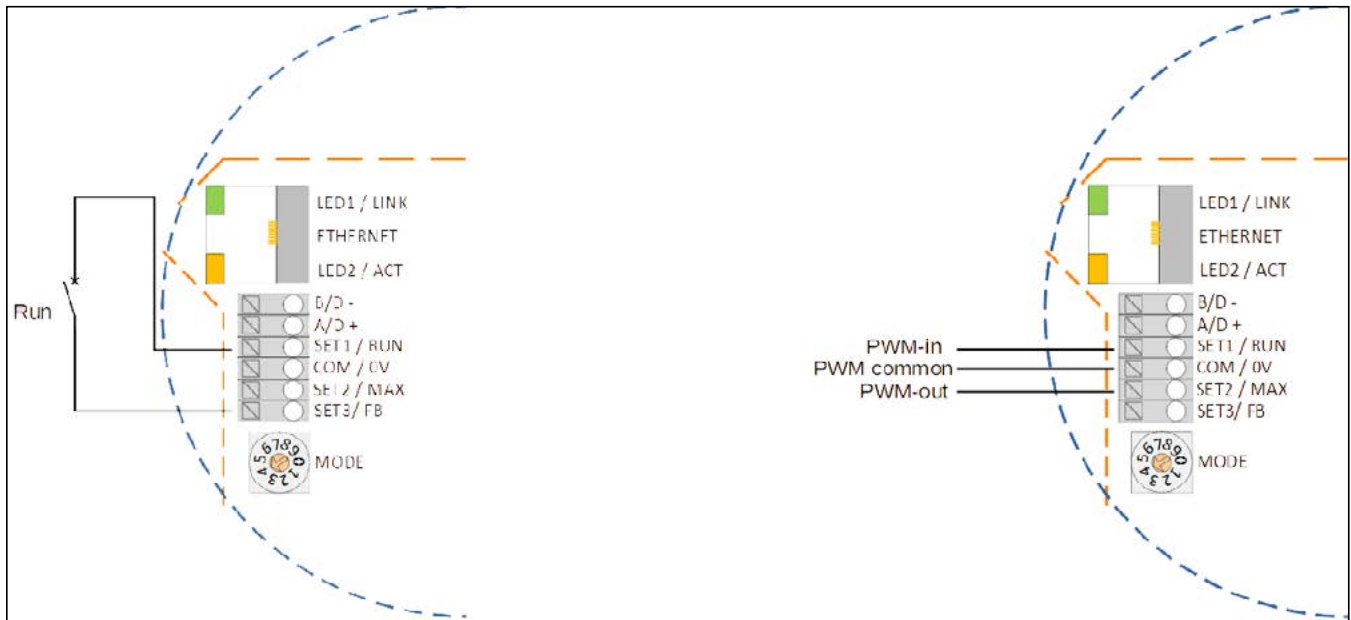

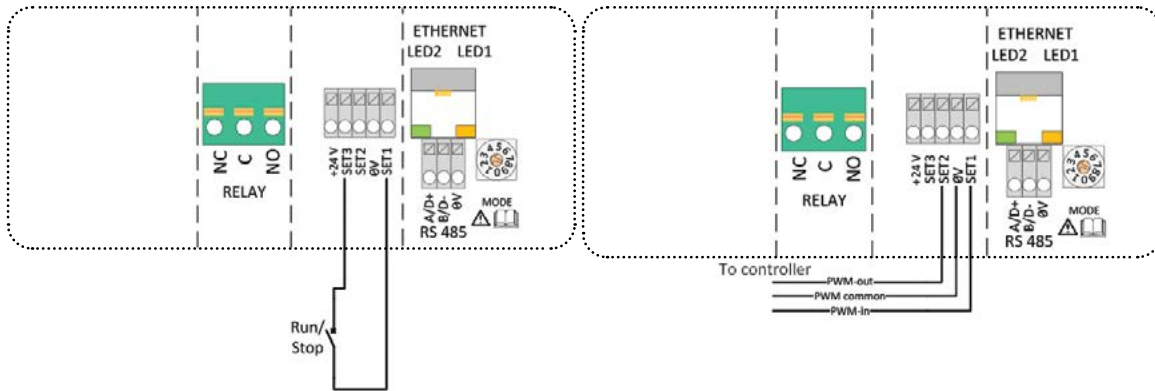

MODE 3 – PWM Solar

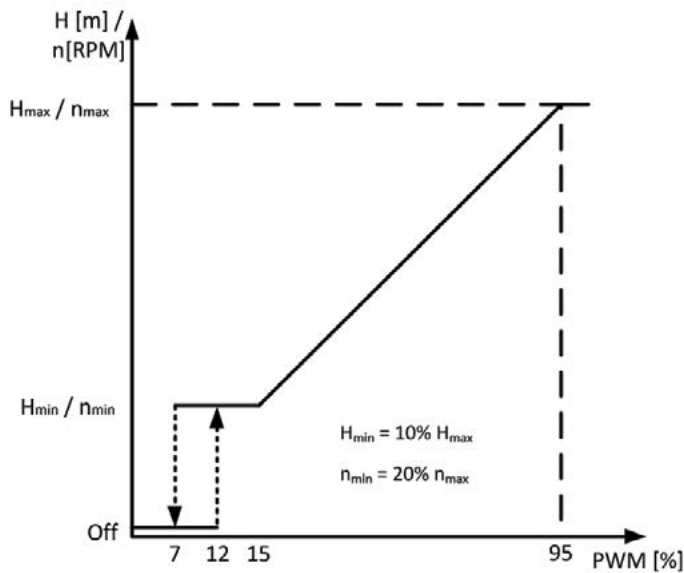

Sequence of Operation:

- Set 3 and Set 1 Open – Pump in Standby (VFD powered, motor is off, no flow), regardless of PWM signal
- Set 3 and Set 1 Closed – increasing PWM signal
 - 0 to 12% pump standby
 - 12% to 15% pump runs at min speed (20% of max speed) or min head (10% of max head)

NOTE: Min speed user adjustable to meet min flow requirements at 3 V

- 15% to 95% speed (or head) increases linearly with % change
- Set 3 and Set 1 Closed – decreasing PWM signal
 - 95% to 15% - speed decreases linearly with % change
 - 15% to 7% - pump runs on min speed
 - 7% to 0 - pump standby

MODE 4 – PWM Heating

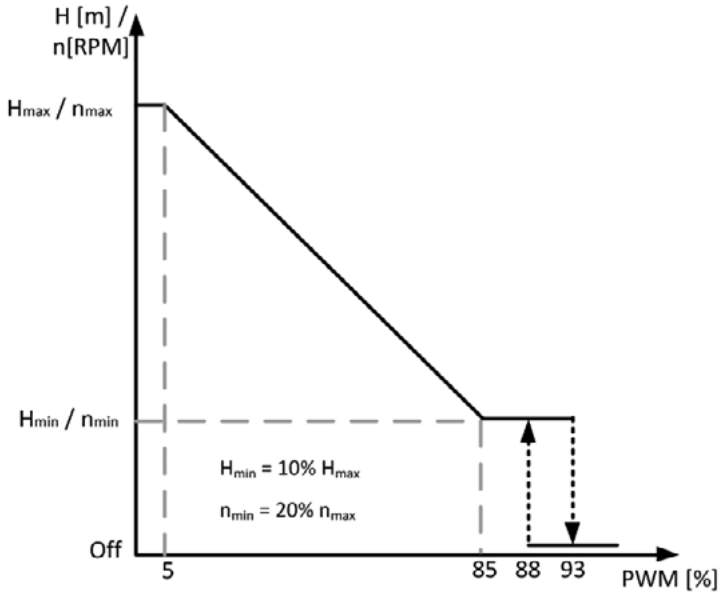

Sequence of Operation:

- Set 3 and Set 1 Open – Pump in Standby (VFD powered, motor is off, no flow), regardless of PWM signal
 - Set 3 and Set 1 Closed – increasing PWM signal
 - 0 to 5% pump at max speed or head
 - 5 to 85% speed decreased linearly with % change
 - 85% to 93% pump on standby
- NOTE: Min speed user adjustable to meet min flow requirements at 3 V)**
- 93% to 0% pump on standby











- Set 3 and Set 1 Closed – decreasing PWM signal
 - 95% to 15% - speed decreases linearly with % change
 - 15% to 7% - pump runs on min speed
 - 7% to 0% - pump standby

SET2 (PWMout)	Status
0%	PWM output interface in short circuit
2.5%	Pump in standby and ready
5%	Normal operation, no flow
5.. 75%	Normal operation, flow indication
75%	Normal operation, maximum nominal flow
80%	Error is present, performance might be reduced
85%	Error is present, pump is still functional, but might be stopped
90%	Error is present, pump is stopped
95%	Error is present, pump is stopped, permanent failure, will not restart
100%	PWM output interface is open circuit or pump is not powered

15. RELAY OUTPUT

Terminal Designation	Terminal description
MODE	Mode selection rotary switch. Used to show and configure mode of operation for relay.
LED1 / LINK	Slowly blinking when module is powered, permanently lid when link established ⁷ .
LED2 / ACT	Flashing yellow when data reception detected. Combined (OR) with Modbus & BACnet data reception indication ⁷ .
NC	Normally closed relay contact. Opens when relay is active.
C	Relay common contact.
NO / OK	Normally open relay contact. Closes when relay is active.

NOTE: VR25-H, VR30-M and VR30-H have one status relay, used to signal pump operation or malfunction. All other models have two relays. See table following for functionality.

Relay Configuration	Output Status	Description	Relay Position	LED status ⁷	
				LED 1	LED 2
0	Error [default]	Only active when the pump is powered up and detects a problem with operation.			
1	Ready	The relay signal is active when the pump is ready for operation.			
2	Operation	The relay signal is active as long as the pump is operating. If the pump comes to a stop or an error occurs, relay will deactivate.			
---	---	Relay output not active.			

Relay configuration number can be modified by either the web interface, Modbus register 012 (relay 1), 17 (relay 2 where applicable) or the Mode switch.

16. NETWORK

Terminal Designation	Terminal description
MODE	Can be used to reset network configuration
LED1 / LINK	Slowly blinking when module is powered, permanently lid when link established.
Ethernet	10BASE-T RJ-45 connector.
LED2 / ACT	Indicates Ethernet activity or Modbus reception.

The communications module has a built in web server which allows you to access your pump directly from an existing Ethernet network. Direct connection to a computer is also possible with a crossover cable.

The web server uses HTML pages to set/view:

- Regulation mode settings
- Regulation parameters (power, RPM, head, flow, efficiency)
- Relay settings
- External control inputs
- Current and previews error
- Pump statistics (power consumption, run time and other).

⁷When Mode 6 or Mode 7 is selected, LED1 and LED2 will show relay configuration. See section "4.3 Module mode selection"

LED is on 

LED is off 

16.1 Bus Topology

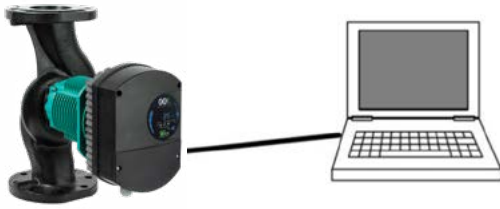

Figure 4: connecting to a computer with a standard cable



Figure 5: connecting to a network via router

16.2 Connection to a Pump Ad-Hoc

When connecting directly with the computer, a standard Ethernet cable must be used to connect with the pump. The pump can then be accessed by typing IP address "192.168.0.245" or "00e" (or "192.168.0.246" or "00e2" if it is a left twin pump) into your web browser's address bar.

16.3 Connection to a Pump via Router

When connecting via a router, Ethernet must be used to connect with the pump. The pump can then be accessed by typing IP address "192.168.0.245" or "00e" or "192.168.0.246" or "00e2" if it's a left twin pump in to your web browser's address bar.

16.4 Local Network Setup, Display & Diagnostics

For advanced setting options and troubleshooting data the pump operational data, settings, network settings, logging of overload history, and software updates the pump controller can be accessed using the html web pages. Note:

- Connection to the internet is NOT required
- Standard or crossover ethernet cables, CAT 5 and above can be used. IMPORTANT: When connecting pump to pump for parallel applications a crossover ethernet cable must be used.
- Due to the drive enclosure NEMA rating, a common RJ-45 ethernet network connector will not fit through the drive opening. If the ethernet cable is intended to be a permanent installation it is recommended to wire the cable end after the cable is fed through the opening in the drive enclosure.
- There are no additional devices or proprietary software required to access the pumps html web pages.

Modbus RTU over RS-485

VR Series is a Modbus RTU lag pump.

Typically, only one lead pump is connected to the serial bus, and one or several lags are also connected to the bus. Lags do not communicate with each other and will never transmit data without receiving a proper request from the master device.

Modbus over Ethernet

Modbus device is available at port 502. Default address is thus 192.168.0.245:502

Supported protocols are:

- Modbus TCP
- Modbus RTU over TCP
- Modbus UDP
- Modbus RTU over UDP

Protocol is automatically recognized according to received packet and no additional configuration is needed.

Instructions for connection:

1. Connect the pump via laptop
 - a. Connect the pump and laptop using a standard or crossover Ethernet cable
 - b. Observe the RJ45 communication LED's with both the pump and laptop powered
 - i. LED1 / LINK: Slowly flashing when powered, solid when link established
 - ii. LED2 / ACT: Flashing yellow when link established
 - c. Open any Web Browser
 - i. IMPORTANT: Connection to the Internet is NOT required
 - d. Enter the pumps IP Address or NetBIOS Name in the web browser
 - i. Default IP is 192.168.0.245
 - ii. Default IP for a Lag or Back-up pump in a parallel application is typically 192.168.0.246
 - e. Once connected, the Pump Overview HTML pages include
 - i. Overview Tab: Displays the pump's real time operational data
 - ii. Pump Tab: Access to various pump setting adjustments and is where the minimum Pump RPM setting is changed. See example below
 - iii. Network Tab: Ability to change the pump network connection
 - iv. Log Tab: Displays current and past error codes
 - v. More Tab: Used to update software and firmware

Overview Pump Network Log More

Welcome!

You have reached **00e series VR 30** circulating pump, named 00E. It is connected to network with IP 192.168.0.245 and MAC 02:01:36:BF:42:AD

Operation data

Op. mode: PROP. PRESSURE
 Power: 4 W (1550 W)
 Head: 0.0 ft H2O (0.0 ft H2O)
 Flow: 0.0 gpm (328.6 gpm)
 RPM: 0 /min (2800 /min)
 Efficiency: 0 %

Control signals

Setpoint: 0.0 % (ANALOG)
 Mode switch: 1
 SET1: OFF 0.00V -0.01mA
 SET2: OFF 0.00V -0.01mA
 SET3: ON 10.49V 0.50mA
 Relay 1: ON

Status

Error codes: 0
 Twin pump: NOT CONNECTED (-4)
 Night mode: OFF
 Motor T: 65 °F
 Heatsink T: 64 °F
 Power cycles: 16

Examples:

Overview Tab: Indicates how the pump is operating in real time values.

Note: no adjustments can be made from this page.

Operation Data: Real time operational data and maximum values

Example: Power is 4 Watts (pump is in standby) – and has a maximum wattage of 1550W, shown in brackets.

Control Signals: Mode switch setting and all external control input settings and actual values.

IMPORTANT: This is where the actual value of a 0-10Vdc signal can be read

Status: Indicates any current error codes, motor and controller temperatures and number of power cycles

Pump Tab: Where pump settings can be made (when not using the user interface)

The screenshot displays a web-based interface for pump configuration. At the top, there are navigation tabs: Overview, Pump (selected), Network, Log, and More. The main content is divided into two columns. The left column, titled 'Pump configuration', provides detailed text descriptions for various operational modes: 'Op. mode' (stop, auto pressure, proportional pressure, constant pressure, constant speed, combined mode), and 'Night mode'. The right column contains two configuration panels. The 'Pump configuration' panel includes dropdown menus for 'Op. mode' (set to COMBINED MODE), 'Max head' (42.0 ft H2O), 'Max RPM' (2800 rpm), and 'Qprop' (50%), along with a checkbox for 'Night mode'. The 'Control configuration' panel includes a 'Mode switch: 1' section with dropdowns for 'SET 1 function' (RUN input 2-3V), 'SET 2 function' (MAX input 2-10V), and 'SET 3 function' (FB output 10.5V), and a 'Relay 1 function' dropdown (PUMP READY). At the bottom right, there is a 'Save all' button.

Pump Configuration: Using the drop down the pump settings can be changed

Op Mode: Changes to Operational Modes can be made using the dropdown (Off, Proportional & Constant Pressure, Constant Speed or Combined Mode)

Max Head: Dropdown selects a specific maximum head (not applicable in Constant Speed Configuration). This value is carried over to the max value in brackets on the Overview Tab

Max RPM: Dropdown sets the maximum speed. IMPORTANT NOTE: If an external speed control input used this value must NOT be set a MAX. Max RPM shown on Overview page.

Qprop: Manually sets the slope of the proportional pressure curve

Night Mode: Toggles Night Setback on and off

Control Configuration: Ability to change the Mode, input, and output settings

Set 1, 2 and 3: Depending on Mode Switch setting various drop-down selections are available

Relay Function: Ability to change the event that changes the relay position (Pump Fault, Pump Ready, Pump Operation, Always on and No Function). Pump Fault is factory default.

Save All: IMPORTANT: Any changes made in this tab require the SAVE button be clicked for the changes to take effect.

The screenshot shows a web interface with a navigation bar at the top containing tabs for Overview, Pump, Network (selected), Log, and More. The main content area is titled "Network configuration" and includes a caution box: "CAUTION: Incorrect settings may cause loss of connectivity. Use Mode switch if needed to reset the settings to factory defaults." Below this, there are several explanatory paragraphs for "NetBios name", "IP address", "Subnet mask", "Gateway", "Twin pump", "DHCP server", and "DHCP client". To the right is a "Network settings" form with input fields for NetBios Name (00E), IP Address (192.168.0.245), DHCP server (checked), DHCP client (unchecked), Gateway (192.168.0.1), Subnet Mask (255.255.255.0), Twin pump (192.168.0.246), and Password. A "Save" button is located at the bottom of the form.

Network Tab:

Network Settings: Edit and configure Network communication, settings for Parallel Pump mode and the ability to set passwords.

LOG Tab:

Event Code: Additional information: Access to the error code history

The screenshot shows the "Log" tab selected in the navigation bar. The main content area is titled "Event code: additional info" and lists four event codes with their descriptions: E11, E43, E51, and E52. A "Clear history" button is located below the list. At the bottom of the page, there is a footer with the text "2.274.0e9a81_15-03-2021_14:14_taco opt: 39, 320".

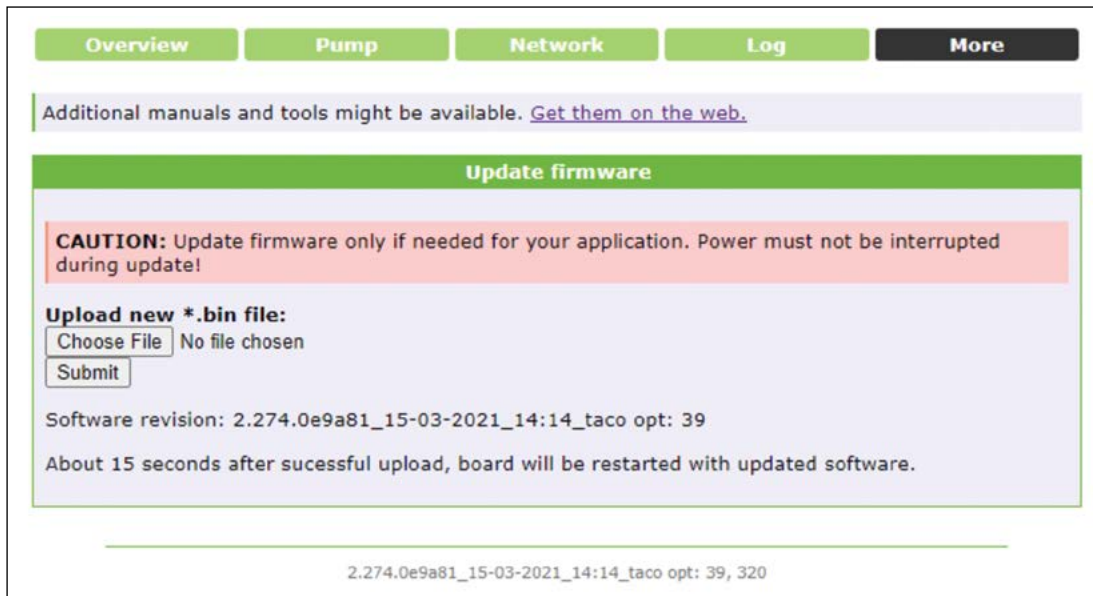

MORE:

Update Firmware: For uploading updates to the software or firmware

Summary Notes:

- For the best troubleshooting experience (product or application) ensure screenshots are taken of at least the Overview and Pump pages
- Always click "Save" when changing settings (Pump and Network)
- If changing the main IP address, it is very important to record and post the new IP address
- Look for network LEDs to light up where the ethernet cable connects to the pump and computer
- Standard or crossover ethernet cable for computer to pump communication
- Crossover cable required for pump-to-pump communication

1. Overview (default page when you connect to the pump, web page OVERVIEW) displays pump operation summary i.e.:

- Operating mode
- Power consumption
- Head
- Estimated flow
- RPM
- Estimated efficiency
- Priority set point
- Mode switch position
- Input/output status
- Replay status
- Error code
- Twin pump status
- Night mode status
- Motor temperature
- Heat sink temperature
- Number of restarts.

2. Pump settings (web page PUMP) is meant to provide regulation and control (input and output) settings.

It has control over:

- Operation mode
- Head limit (depending on pump mode)
- RPM limit (depending on pump mode),
- Ratio between head and flow HQ (depending on pump mode)
- Input/output control.
- Relay control.

Setting can be saved to permanent memory by pressing the SAVE button.

3. Network settings (web page NETWORK) provide a way to change network configuration:

- NetBIOS name - is a local network name service. Instead of '192.168.0.245' you can for example use 'http://00e'. Default: 00e,
- Pump IP address - is a pump network address. The pump is seen as http server on this address, default: 192.168.0.245,
- DHCP server - provides lease for "point to point" connection (cross-over cable to computer for example). Will disable itself if another DHCP server is found,
- DHCP client will automatically acquire DHCP address from the network,
- Default gateway – provides connection route to larger networks. This is usually a router address, default: 192.168.0.1,
- Subnet mask - sets subnet address range that is on the same subnet and can be reached directly. The rest of communication goes over the gateway, default: 255.255.255.0,
- Twin mode with IP - will connect two pumps for alternating operation. When two pumps are configured for twin mode, they will switch about once per day. Setting this field to inexistent IP will disable this option! Set it so the first pump references the second and vice versa. Default: 192.168.0.246.

Setting can be saved to permanent memory by pressing the SAVE button.

4. Log (web page LOG) displays possible previous and current errors.

5. MORE (web page MORE) has links to additional manuals and tools that might be available. Has an option to update VR Series modules software, by user inputted software file (available at your local serviceman or our webpage).

17. BACnet

17.1 BACnet MS/TP communication is standard with all VR models

VR Series module enables BACnet MS/TP communication with all models.

BACnet Standardized Device Profile (Annex L):

- BACnet Operator Workstation (B-OWS)
- BACnet Advanced Operator Workstation (B-AWS)
- BACnet Operator Display (B-OD)
- BACnet Building Controller (B-BC)
- BACnet Advanced Application Controller (B-AAC)
- BACnet Application Specific Controller (B-ASC)
- BACnet Smart Sensor (B-SS)
- BACnet Smart Actuator (B-SA)

BACnet Interoperability Building Blocks Supported (Annex K):

Name	BACnet BIBB
Read Property	DS-RP-B
Write Property	DS-WP-B

Device management services:

Name	BACnet BIBB
Who-is/I-am	DM-DDB-A DM-DDB-B
Who-has/I-have	DM-DOB-B

NOTE: Segmentation is not supported.

NOTE: Dynamically creatable objects are not supported.

17.2 Data Link LAYER Options

- MS/TP master (Clause 9), baud rate(s):

Baud Rate
9600
19200
38400 [default]

- BACnet IP

(CURRENTLY NOT IMPLEMENTED)

17.3 Device Address Binding

Is static device binding supported? (This is currently necessary for two-way communication with MS/TP lag pumps and certain other devices.)

Yes No

17.4 Networking Options

None

17.5 Network Security Options

Non-secure Device - is capable of operating without BACnet Network Security

17.6 Character Sets Supported

ISO 10646 (UTF-8) IBM™/Microsoft™ DBCS ISO 8859-1
 ISO 10646 (UCS-2) ISO 10646 (UCS-4) JIS X 0208 ANSI X3.4

17.7 Supported BACnet Interoperability Building Blocks

Data sharing services:

Name	BACnet BIBB
Read Property	DS-RP-B
Read Property Multiple	DS-RPM-B
Write Property	DS-WP-B
Write Property Multiple	DS-WPM-B
Subscribe COV	DS-COV-B

Device management services:

Name	BACnet BIBB
Who-is/I-am	DM-DDB-A DM-DDB-B
Who-has/I-have	DM-DOB-B
Device Communication Control	DM-DCC-B

NOTE: Segmentation is not supported.

Object Types Supported				
Device	Binary output	Analog input	Binary input	Analog output

NOTE: Dynamically creatable objects are not supported.

17.8 Analog Inputs (Object Type 0) • NOTE: Values are read-only

Instance	Object Name	Unit	Description
AI.0	Actual Set Point	%	Currently active Setpoint - 100% represents maximum - Pump performance depending on Control Mode - <0% indicates user control
AI.1	Actual Operating Mode	---	Current pump operating mode - Mirrors AO.1 when remotely controlled - See AO.1 for possible values
AI.2	Head	ft (H ₂ O)	Estimated pump head
AI.3	Flow	GPM	Estimated flow
AI.4	Power	W	Electrical power of the pump
AI.5	Speed	RPM	Motor speed
AI.6	Motor Temperature	°F	Medium or motor temperature
AI.7	Heatsink Temperature	°F	Controller temperature
AI.8	HMax	ft (H ₂ O)	Maximum pump head
AI.9	QMax	GPM	Maximum pump flow
AI.10	PMax	W	Rated pump power
AI.11	RPMMax	W	Maximum motor speed
AI.12	Operating Hours	h	Time active (not implemented = 0)
AI.13	Energy Consumed	kWh	Total electrical energy (not implemented = 0)
AI.14	Active Error Code	---	Currently active error. 0 = pump is operating without problems. This value will always be non-zero when there is an error present. (See section 19 "Error codes" for code details)

17.9 Analog Outputs (Object Type 1)

Instance	Object Name	Unit	Description
AI.0	Bus Set Point	%	Currently active Setpoint - 100% represents maximum - 0% stops the pump - Set B0.0 to enable
AI.1	Bus Operating Mode	---	Current pump operating mode - 0: Auto mode (only on/off) - 1: Proportional pressure, setpoint controls peak head - 2: Constant pressure, setpoint controls head - 3: Constant RPM, setpoint controls speed. - Other values reserved - Set B0.0 to enable

17.10 Binary Inputs (Object Type 3) • NOTE: Values are read-only

Instance	Object Name	Unit	Description
BI.0	Remote Access Active	---	Indicates remote control 0 = Local 1 = Remote (Bus control).
BI.1	Near Minimum Speed	---	Indicates if the pump is running near minimum speed. 0 = No 1 = Yes. This flag is set when speed falls below 1/3 of rated maximum
BI.2	Near Maximum Speed	---	Indicates if the pump is running near maximum speed. 0 = No 1 = Yes. This flag is set when power or speed is over 95% of rated maximum.

17.11 Binary Outputs (Object Type 4)

Instance	Object Name	Unit	Description
BO, 0	Remote Access Enable	---	Control bit that sets local or remote control. Setting this bit will enable pump control over BACnet. 0 = Local 1 = Remote
BO, 1	Reset Faults	---	Setting to 1 will try to clear any pending faults (not needed as faults are auto cleared) 0 = No reset 1 = Trigger reset
BO, 2	Save Configuration	---	Write analog outputs to non-volatile memory. After next power cycle, pump will start with saved configuration. 0 = No reset 1 = Trigger save

18. MODBUS

18.1 Modbus Related Interface

Terminal Designation	Terminal Description
MODE	Can be used to reset network configuration.
LED2 / ACT	Indicates Ethernet activity or Modbus reception.
B/D-	RS-485 negative data signal for Modbus.
A/D+	RS-485 positive data signal for Modbus.
COM/0V	RS-485 common and analog input common (ground).

18.2 Modbus Topology

The VR Control is a Modbus lag, connected directly to a Modbus RTU network. Connection can be made in either daisy chain style (if cabling allows such a connection) or a limited length passive tap. Schematic example is in Figure 6.

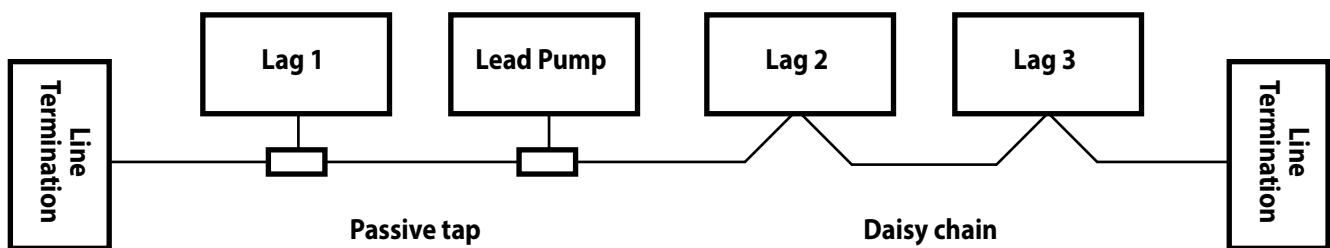

Figure 6: Example of Modbus network

Typically, only one Lead pump device is connected to the serial bus, and one or several lags are also connected to the bus. Lags do not communicate with each other and will never transmit data without receiving a proper request from the master device.

Up to 32 single load devices can be connected to one RS-485 Modbus system without using a repeater. As this module is a 1/8 load device, up to 256 modules can be connected to the bus. Repeaters can be used to extend the maximum transmission distance and increase device count if needed.

18.3 Connection to Modbus

Connection to RS-485

A screened, twisted-pair cable should be used. The cable screen must be connected to the COM terminal and connected to safety ground at one point.

NOTE: In some cases, better performance is achieved if no COM connection is made. Device can operate with 2 wire connection.

Speed, parity and address

Modbus RTU

By default, each device is set to 19200-E-1 (even parity), address 245. Properly set registers in section "0 VR control register" to configure each device before connecting it to existing network. Optionally power each device one by one, configuring the settings before adding another one.

Termination

VR Series module contains neither termination nor bias circuitry. RS-485 wiring should be externally terminated if needed.

For short wiring and/or low baud rate, interface can operate without termination. However, it is recommended that termination (100-150 ohm resistor) is added on both ends of bus wiring. There are wiring length limits regarding to speed and termination:

Maximum speed [baud]	Maximum cable length ft. (m)
38400	4000 (1200), terminated cable
9600	4000 (1200)
19200	1600 (500)
38400	800 (250)

NOTE: Any branch/derivative cable is considered unterminated. Keep them short, below 250m combined for maximum speed and reliability.

Ethernet bus

Ethernet related interface

Terminal Designation	Terminal description
MODE	Can be used to reset network configuration.
LED1 / LINK	Slowly blinking when module is powered, permanently lid when link established.
Ethernet	10BASE-T RJ-45 connector.
LED2 / ACT	Indicates Ethernet or RS-485 activity.

Services

- Http server on port 80
- Modbus server on port 502

Register overview

VR Series Modbus RTU registers are grouped in the following register blocks:

Start Address	Register block	Readable/Writeable	Description
001	VR Series configuration	R/W	Configuration of the VR module.
021	VR Series status	R	Status registers for the VR module.
101	Pump control	R/W	Pump control registers.
201	Pump status	R	Status data from the pump.
301	Pump data	R	Measured data from the pump.

All addresses contain 16 bit (one Word) registers. Some are bit interpreted while others are combined for a 32 bit value.

NOTE: All register addresses are 1-based. Address 001 is thus transmitted over bus as 0x0000.

VR control registers

Registers in this block are read with either function codes 0x03 or 0x04. They can be written as holding registers with function codes 0x06 and 0x10.

NOTE: All values in this block are stored in nonvolatile memory immediately after write.

NOTE: See section "Error! Reference source not found. Error! Reference source not found." and use Mode 8 or 9 to restore default settings if you cannot access the controller after writing to these registers.

Address	Register name	Range	Resolution	Description
001	Lag Delay	0..10000	1 ms	Delay in milliseconds for lag reply. This delay will be added to every Modbus reply [default = 0].
002	RESERVED	---	---	---
003	ModbusAddress	1..247	1	Modbus lag/device address [default = 245].
004	BitRate	0..5	1	RS-485 transmission speed enumeration. 0 = 1200 baud 1 = 2400 baud 2 = 4800 baud 3 = 9600 baud 4 = 19200 baud [default] 5 = 38400 baud 6 = 57600 baud
005.. 008	RESERVED	---	---	---
009	Parity	0..2	1	Parity setting to be used for communication. 0 = No parity 1 = Even parity [default] 2 = Odd parity
010	StopBits	1..2	2	Stop bits used for communication. 2 stop bits will only be used when "Parity" is set to 0. 1 = 1 stop bit [default] 2 = 2 stop bits
011	RESERVED	---	---	---
012	Relay1Control	0..2	1	Configures module relay output. 0 = indicates fault 1 = indicates pump ready 2 = indicates pump operation See section "Error! Reference source not found. Error! Reference source not found."
013	ErrorDelay	0..30	1	Error signal on Relay and register 201.10 will be delayed by ErrorDelay seconds.

Address	Register name	Range	Resolution	Description
014	SET1Type	---	1	Configuration for SET1 terminal. 0 = "NO FUNCTION" 1 = "RUN input 2-3V" 2 = "MAX input 0-10V" 3 = "MAX input 2-10V" 4 = "RUN input 4-6mA" 5 = "MAX input 0-20mA" 6 = "MAX input 4-20mA" 7 = "FB output 10.5V" 8 = "FLOW output 2-10V" 9 = "FLOW output 4-20mA" 10 = "RPM output 2-10V" 11 = "RPM output 4-20mA" 12 = "ERROR output 10-0V" 13 = "ERROR output 20-0mA" 14 = "PWM SOLAR input" 15 = "PWM HEATING input" 16 = "PWM FLOW+ERR output"
015	SET2Type	---	1	Configuration for SET2 terminal. See enumeration for register 014
016	SET3Type	---	1	Stop bits used for communication. 2 stop bits will only be used when "Parity" is set to 0. 1 = 1 stop bit [default] 2 = 2 stop bits
017	Relay2Control	0..2	1	Configures module relay output. 0 = indicates fault 1 = indicates pump ready 2 = indicates pump operation See section "Error! Reference source not found. Error! Reference source not found."

VR status registers

Registers in this block are read with either function codes 0x03 or 0x04. They are read-only. This block can be used for various kinds of fault finding.

Address	Register name	Resolution	Description
021..022	RESERVED	---	---
023	Software Version	0.1	Module software version
024..029	RESERVED	---	---
030	Product Version	1	Product version [32x for module, x denotes hardware revision]
031	RESERVED	---	---
032	Software Version	0.1	Module software version[10 = 1.0]

Pump control registers

Registers in this block are read with either function codes 0x03 or 0x04.

They can be written as holding registers with function codes 0x06 and 0x10.

Address	Register name	Range	Description
101	ControlReg	b0: RemoteAccess	Control bit that sets local or remote control. Setting this bit will enable pump control over Modbus. 0 = Local 1 = Remote (controlled by Modbus master).
		b1: OnOffReq	Control bit that switches the pump on or off. 0 = Off (stop) 1 = On (start).
		b2..3: RESERVED	---
		b4:	Control bit saves values in register block as default. 0 = No save 1 = Save as default. This value will be reverted back to 0 when set.
		b5..15: RESERVED	---
102	AltControlMode	---	Alternative Control mode. Use of register 108 is preferred. Sets the control mode enumeration. 0 = ConstantRPM 1 = ConstantRPM 3 = ConstantHead 4 = ConstantHead 5 = ConstantHead 6 = ProportionalHead 128 = AutoHeadMode NOTE: values outside this range reserved.
103	Operation Mode	---	RESERVED
104	SetPoint	0.. 10000	Sets desired pump set point. 0 will stop the pump. 10000 will set the pump to maximum output for desired mode. Values outside of valid range will cause the pump to operate with front panel set values.
105	RelayControl	0..2	Configures relay output. 0 = indicates fault 1 = indicates pump ready 2 = indicates pump operation See section " Error! Reference source not found. Error! Reference source not found. "
106..107	RESERVED	---	---
108	ControlMode	0..3	Sets the pump control mode. 0 = AutoHeadMode (Automatic head mode) 1 = ProportionalHead (Head proportional to flow) 2 = ConstantHead (Head is kept constant) 3 = ConstantRPM (Speed is kept constant) NOTE: values outside this range reserved. See section " Error! Reference source not found. Error! Reference source not found. " for exact parameter to be controlled.

Pump status registers

Registers in this block can be read by means of function codes 0x03 and/or 0x04. They are read-only.

Address	Register name	Description
201	StatusReg	---
	b0..b5: RESERVED	---
	b6: Rotation	Indicates if the pump is rotating (running) or not. 0 = No rotation 1 = Rotation.
	b7: RESERVED	---
	Bit 8: AccessMode	Indicates if the pump is locally or remotely controlled. 0 = Local (a source with higher priority controls the pump) 1 = Remote (controlled by Modbus master).
	Bit 9: IsOn	Indicates if the pump is on or off. 0 = Off 1 = On It not necessarily indicate rotation as an error might stop the pump.
	Bit 10: Error	Indicates if there is a problem with proper operation. 0 = No problem 1 = Error present. Pump might still run.
	Bit 11: RESERVED	---
	Bit 12: RESERVED	---
	Bit 13: NearMaxSpeed	Indicates if the pump is running near maximum speed. 0 = No 1 = Yes. This flag is set when power or speed is over 95% of rated maximum.
	Bit 14: RESERVED	---
Bit 15: NearMinSpeed	Indicates if the pump is running near minimum speed. 0 = No 1 = Yes. This flag is set when speed falls below 1/3 of rated maximum.	
202	RESERVED	(TBD)
203	ControlMode	Indicates the actual control mode. 0 = ConstantRPM 1 = ConstantRPM 3 = ConstantHead 4 = ConstantHead 5 = ConstantHead 6 = ProportionalHead 128 = AutoHeadMode.
204	RESERVED	---
205	ErrorCode1	Current first error code. 0 - when pump is operating without problems. This value will always be non-zero when there is an error present. See section "Error! Reference source not found. Error! Reference source not found." for code details.
206	ErrorCode2	Second error code. Non-zero when there is more than one error. See section "Error! Reference source not found. Error! Reference source not found." for code details.
207	ErrorCode3	Third error code. Non-zero when there is more than two errors. See section "Error! Reference source not found. Error! Reference source not found." for code details.
208	ControlMode	Indicates the actual control mode. 0 = AutoHeadMode (Automatic head mode) 1 = ProportionalHead (Head proportional to flow) 2 = ConstantHead (Head is kept constant) 3 = ConstantRPM (Speed is kept constant). NOTE: values outside this range reserved. See section "Error! Reference source not found. Error! Reference source not found." for exact parameter to be controlled.

Pump data registers

Registers in this block can be read by means of function codes 0x03 and/or 0x04. They are read-only.

Address	Register name	Range	Resolution	Description
301	Head	---	0.01 m	Pump head estimation in meters of water column.
302	Flow	---	0.1 m ³ /h	Pump flow estimation.
303	Efficiency	---	0.01 %	Estimated pump efficiency.
304	Speed	---	1 rpm	Motor speed.
305	Frequency	---	0.1 Hz	Motor frequency [100.0 Hz for 3000 rpm and 4 pole motor].
306..307	RESERVED	---	---	---
308	ActualSetPoint	0..10000	0.01 %	Indicates actual set point of the pump. (-1 for internal pump regulation), tbd
309..311	RESERVED	---	---	---
312	PowerHI	0..2 ³²	1 W	Total power consumption of the system.
313	PowerLO	0..2 ³²	1 W	Total power consumption of the system.
314..317	RESERVED	---	---	---
318	CircuitTemp	-5500.. 16000	0.01 °C	Power electronics hotspot temperature.
319	MotorTemp	-5500.. 16000	0.01 °C	Motor compartment temperature.
320..321	RESERVED	---	---	---
322	LiquidTemp	-5500.. 16000		Liquid temperature.
323..326	RESERVED	---	---	---
327	OperationTimeHI	---	1 hour	Total operation time (above zero speed) of the pump. ¹
328	OperationTimeLO	---	1 hour	Total operation time (above zero speed) of the pump. ¹
329	TotalPoweredTime- HI	---	1 hour	Total power-on time of the module. ¹
330	TotalPoweredTime- LO	---	1 hour	Total power-on time of the module. ¹
331	RESERVED	---	---	---
332	EnergyHI	---	1 kWh	Total energy consumption of the system. ¹
333	EnergyLO	---	1 kWh	Total energy consumption of the system. ¹

¹ Not available on all models.

19. FAULT FINDING

19.1 Error Codes

The following error codes will be displayed on the user interface, HTML Pump Overview tab (Status) for current error, HTML Log tab for error history and the appropriate Modbus and BACnet registers.

Error categories

E1x Motor Load Errors

E2x Overload Protection Errors

E3x Pump Errors

E4x Device Specific Error Codes

E5x Motor Error Codes

Error code details (cause, solution and pump reaction)

Error	Fault Description	Cause	Pump Reaction / Solution
E10	Low Motor Load (probable dry run)	Check for air at pump (low or no inlet pressure. If pump noisy, check for impeller damage. If pump in error is on a secondary piping system, the primary pump could be pumping through the secondary causing a low load.	Pump runs at minimum speed until load is increased to the required minimum (pump system is pressurized or air lock is removed). If oversized primary suspected, turn off primary and observe secondary
E11	High Motor Load (excessive wattage)	Possible causes: Binding of the rotating assembly, uncontrolled excessive flow, viscous pumping fluids or misalignment of the impeller eye and volute seal ring.	Pump runs at normal speed, limited by wattage, until the cause is corrected. Check rotating assemble including sleeve bearings for contamination, insure the pump is not running off it's curve. If glycol used for freeze protection, confirm % concentration (should not need to exceed 40%) and monitor as the system temperature increases. For misalignment, inspect the impeller area in the outlet side of the volute. Missalignment will occur during the motor alignment process
E24	Converter Overload	IGBT transistor fault. Check motor mechanically and electrically, check motor electrical connections. Check motor mechanically for external water leaks, build up of stator condensation or thermal damage. Misalignment of the impeller eye and volute seal ring	Confirm stator housing condensate drain slots are open and not insulated over
E25	Over voltage	High input voltage or electronic board failure	Pump runs normally If voltage within range, change the pump
E26	Under voltege	Low input voltage, electronic board failure or flow through pump when off.	Pump runs at a lower power Check input power.
E27	PFC overcurrent	PFC fault	Pump will not run Change the frequency converter or change the pump For misalignment, inspect the impeller area in the outlet side of the volute. Misalignment will occur during the motor alignment process. close a valve near the pump (error should be eliminated) If flow through off pump and voltage are confirmed ok, replace the pump
E31	Software motor protection active	Loose contact, check motor mechanically	Pump will not run Reconnect bimetal

Error Codes Continued

Error	Fault Description	Cause	Pump Reaction / Solution
E42	Faulty LED	LED on the User Interface failure	Pump runs normally, but no display Check ribbon cable connection between the board and drive cover. If OK, replace the drive cover
E43	Communications failed	Loose contact	Pump runs normally. Reconnect or change the cable
E51	Motor software protection active	IGBT transistor fault. Check motor mechanically and electrically, check motor electrical connections. Check motor mechanically for external water leaks, build up of static condensation or thermal damage. Misalignment of the impeller eye and volute seal ring	Pump will not run. For misalignment, inspect the impeller area in the outlet side of the volute. Misalignment will occur during the motor alignment process. If OK perform a hard reset (power pump off / on)
E52	Excessive motor temperature	Motor is too hot	Pump will not run until the motor temperature is reduced. May require a hard reset to remove error. Reduce ambient temperature around pump, Check for fluid temperatures above 220° F. Ensure motor is installed horizontally. Conform pump is operating within allowable Watts and Amperage (ensure the pump is not running off it's curve)
E53	Pump model invalid or out of range	Software does not match the pump model	Pump will run, but at wrong power and speed settings. Reflash the pump »bin« software using the HTML More Tab
hi	Pump set to max RPM	RPM setting and application mismatch	If the pump does not change speeds as expected, reduce speed by 100 RPM. RPM will show in place of hi and speed modulation will occur.



Performance Curves

VR15 & VR20

ECM High-Efficiency Circulators



VR Circulators are available in High (H), Medium (M) and Low (L) Head Models

VR15 Performance Curves

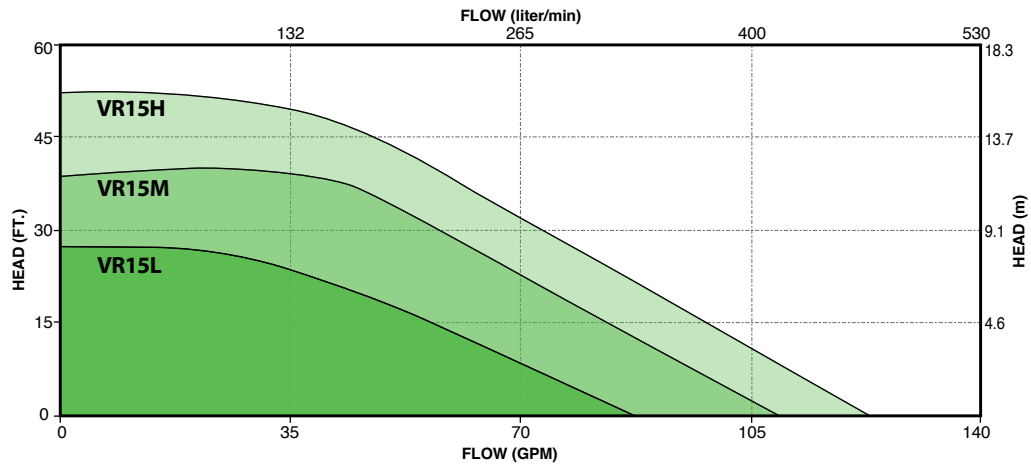

VR20 Performance Curves

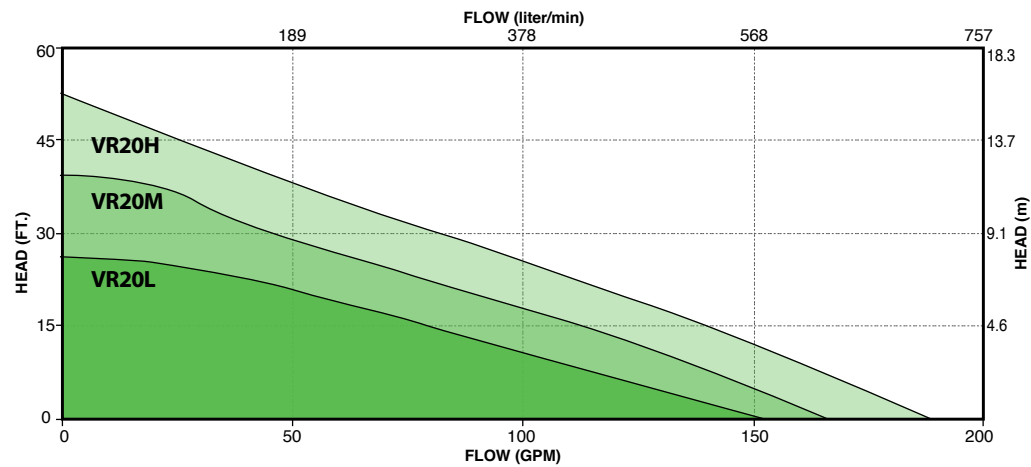



Performance Curves

VR25 & VR30

ECM High-Efficiency Circulators



VR Circulators are available in High (H), Medium (M) and Low (L) Head Models

VR25 Performance Curves

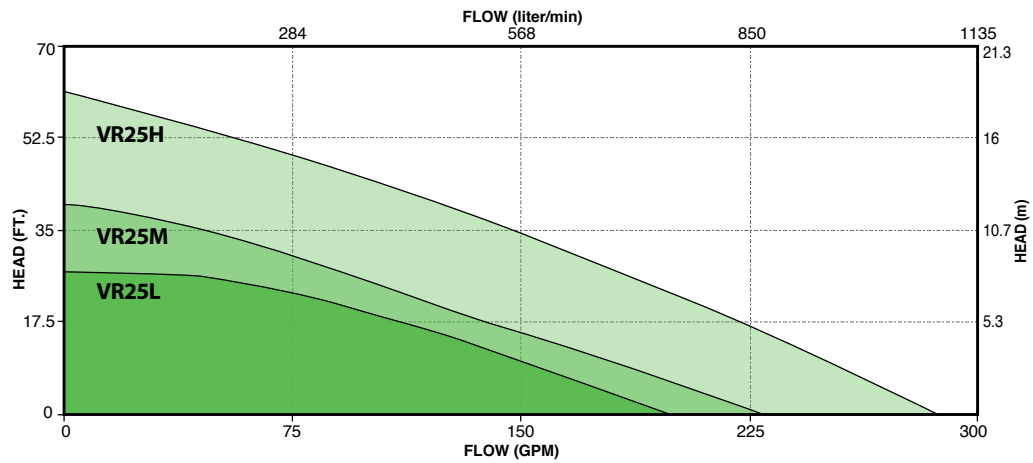

VR30 Performance Curves

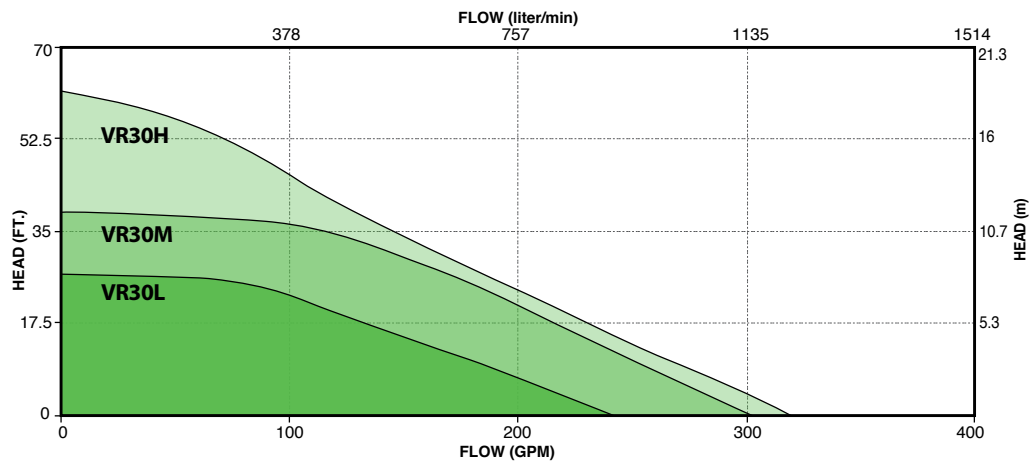

VR15 (L / M / H)

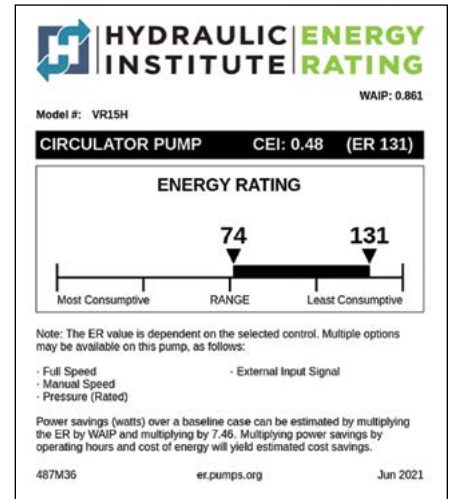
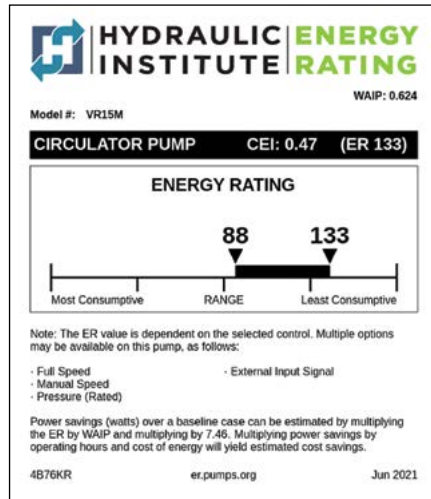
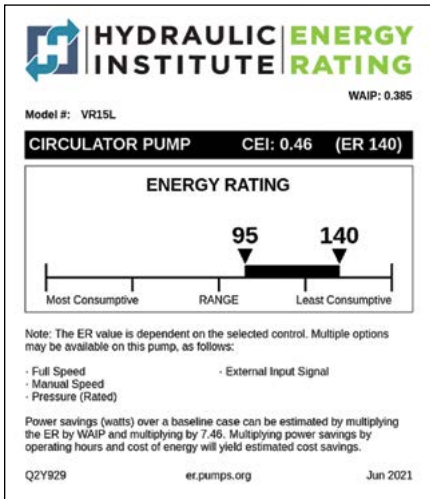

VR20 (L / M / H)

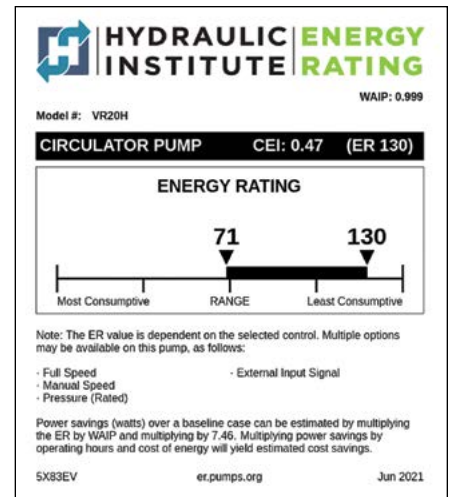
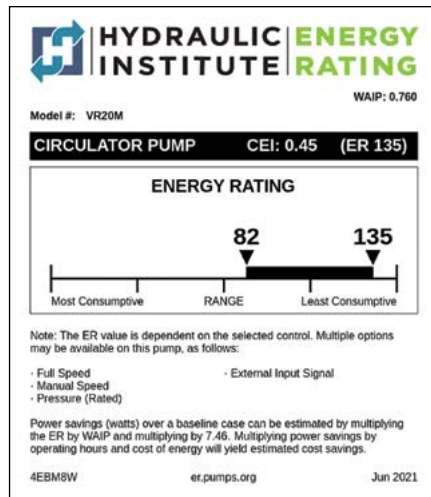
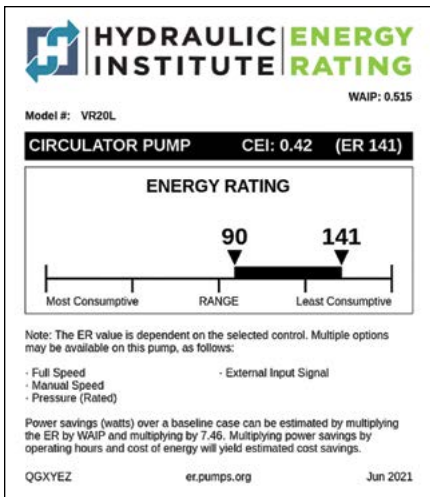

VR25 (L / M / H)

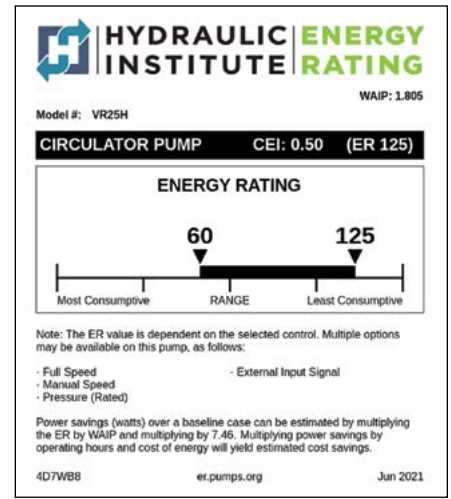
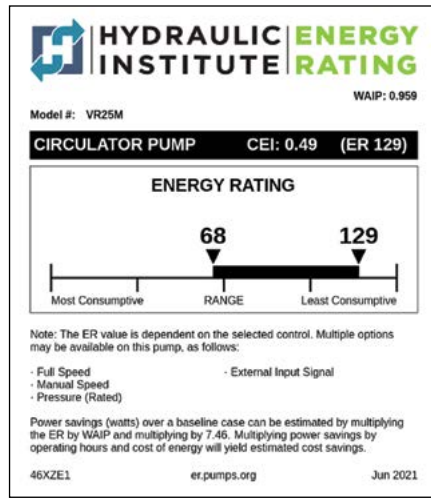
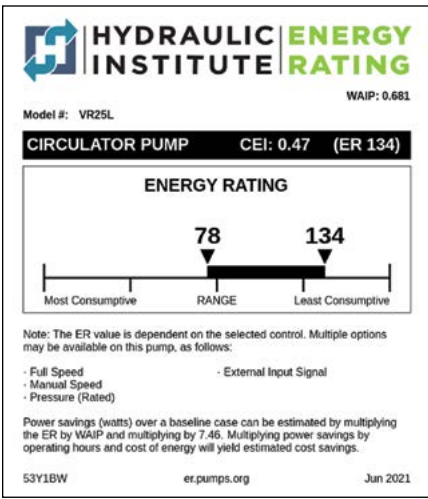

VR30 (L / M / H)

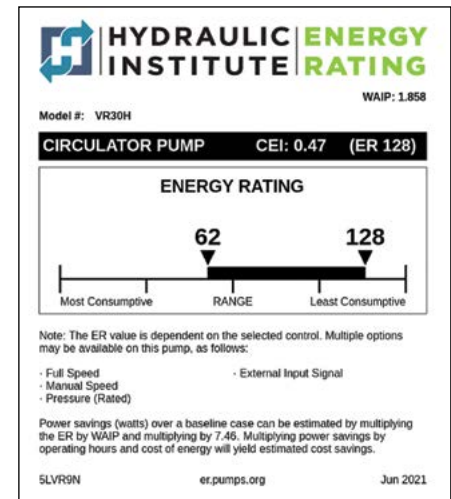
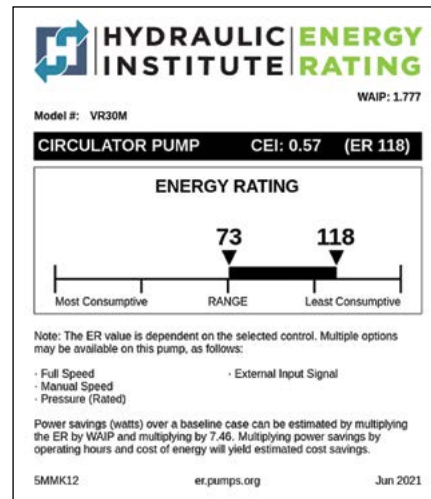
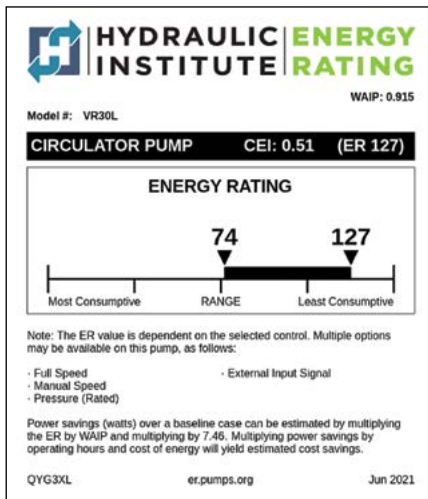

LIMITED WARRANTY STATEMENT

Taco, Inc. will repair or replace without charge (at the company's option) any product or part which is proven defective under normal use within one (1) year from the date of start-up or one (1) year and six (6) months from date of shipment (whichever occurs first).

In order to obtain service under this warranty, it is the responsibility of the purchaser to promptly notify the local Taco stocking distributor or Taco in writing and promptly deliver the subject product or part, delivery prepaid, to the stocking distributor. For assistance on warranty returns, the purchaser may either contact the local Taco stocking distributor or Taco. If the subject product or part contains no defect as covered in this warranty, the purchaser will be billed for parts and labor charges in effect at time of factory examination and repair.

Any Taco product or part not installed or operated in conformity with Taco instructions or which has been subject to misuse, misapplication, the addition

of petroleum-based fluids or certain chemical additives to the systems, or other abuse, will not be covered by this warranty.

If in doubt as to whether a particular substance is suitable for use with a Taco product or part, or for any application restrictions, consult the applicable Taco instruction sheets or contact Taco at [401-942-8000].

Taco reserves the right to provide replacement products and parts which are substantially similar in design and functionally equivalent to the defective product or part. Taco reserves the right to make changes in details of design, construction, or arrangement of materials of its products without notification.

TACO OFFERS THIS WARRANTY IN LIEU OF ALL OTHER EXPRESS WARRANTIES. ANY WARRANTY IMPLIED BY LAW INCLUDING WARRANTIES OF MERCHANTABILITY OR FITNESS IS IN EFFECT ONLY FOR THE DURA-

TION OF THE EXPRESS WARRANTY SET FORTH IN THE FIRST PARAGRAPH ABOVE.

THE ABOVE WARRANTIES ARE IN LIEU OF ALL OTHER WARRANTIES, EXPRESS OR STATUTORY, OR ANY OTHER WARRANTY OBLIGATION ON THE PART OF TACO.

TACO WILL NOT BE LIABLE FOR ANY SPECIAL, INCIDENTAL, INDIRECT OR CONSEQUENTIAL DAMAGES RESULTING FROM THE USE OF ITS PRODUCTS OR ANY INCIDENTAL COSTS OF REMOVING OR REPLACING DEFECTIVE PRODUCTS.

This warranty gives the purchaser specific rights, and the purchaser may have other rights which vary from state to state. Some states do not allow limitations on how long an implied warranty lasts or on the exclusion of incidental or consequential damages, so these limitations or exclusions may not apply to you.

