

Model shown contains optional Seal Fail circuitry.

COMPONENTS

- a. ON/OFF Switch - Control/Alarm Power
- b. 120V Incoming Power Terminals
- c. Power LED - (Green)
- d. Pump HOA Switches
- e. Float LEDs - (Red) x4
- f. Pump LEDs
Pump Run - (Green)
Pump Fail - (Red)
- g. Simulate Float Buttons x4
- h. Float Terminals x8
- i. Lead/Lag Selector Switch
- j. Dual Seal Fail Pot - (Optional)
- k. Dual Seal Fail LEDs - (Red) - (Optional)
- l. Auxiliary Alarm Terminals

PROGRAMMING INSTRUCTIONS

WITH POWER ON, HOAs OFF, FLOATS OFF OR DISCONNECTED, PRESS DESIRED FLOAT BUTTON RAPIDLY 4 TIMES AND HOLD

PUMP LEDs WILL FLASH UPON SUCCESSFUL PROGRAMMING

OPTIONS	FLOAT BUTTON	DEFAULT	OPERATION
PUMP FAIL ALARM	STOP	ON	ACTIVATES IF A PUMP CAUSES "LAG" 3 CYCLES IN A ROW
MANUAL ALARM RESET	LEAD	OFF	LATCHES HIGH ALARM: CLEAR WITH EXTERNAL TEST SWITCH
SEAL FAIL HORN	LAG	OFF	ACTIVATES HORN UPON SEAL FAIL
ALARM FLASHER	ALARM	OFF	FLASHES BEACON UPON HIGH ALARM

ALARM CONDITIONS

ALARM	BEACON	CONTROLLER LED	HORN
PUMP FAIL	FLASHING	RED PUMP LIGHT	NO
SEAL FAIL	FLASHING	SF1, SF2	PROG
FLOAT FAIL	FLASHING	BAD FLOAT NOT LIT	NO
HIGH ALARM	SOLID	ALARM FLOAT	YES

Liberty Pumps®

A Family and Employee Owned Company

Three Phase Duplex

AE34=3-131, AE34=3-141, AE34=3-171,
AE34=3-191, AE34=3-511, AE34=4-131,
AE34=4-141, AE34=4-171, AE34=4-191,
AE34=4-511, AE54=3-121, and AE54=4-121

Manufactured by SJE Rhombus®

Installation and Operation Manual

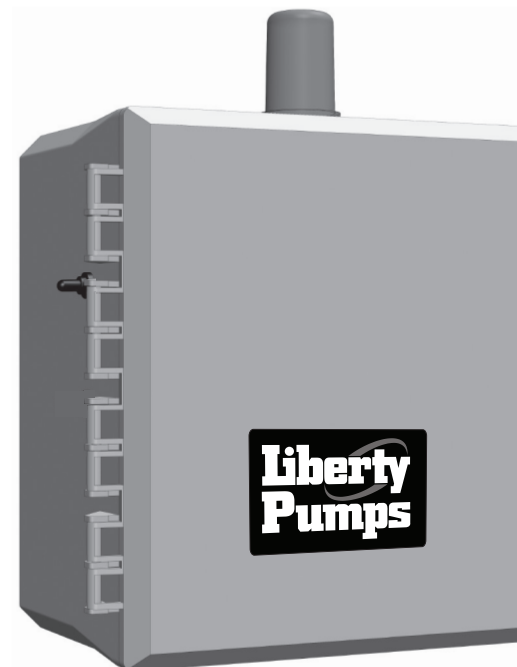

Parts Included

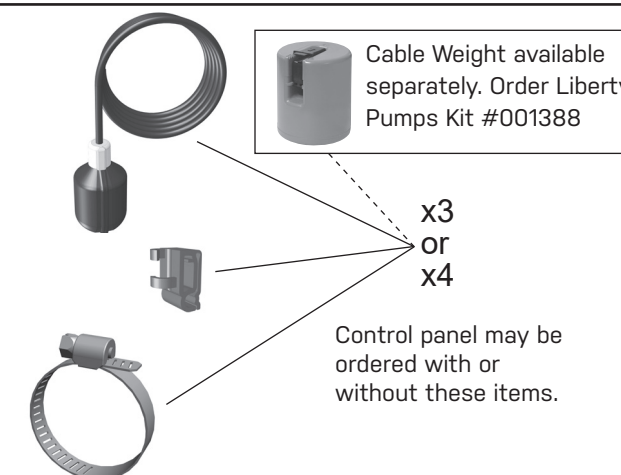
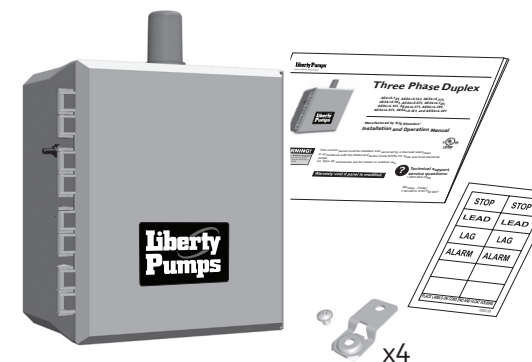

Cable Weight available separately. Order Liberty Pumps Kit #001388

x3
or
x4

Control panel may be ordered with or without these items.

WARNING!

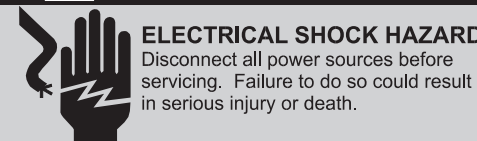

ELECTRICAL SHOCK HAZARD
Disconnect all power sources before servicing. Failure to do so could result in serious injury or death.

This control panel must be installed and serviced by a licensed electrician in accordance with the National Electric Code NFPA-70, state and local electrical codes. UL Type 4X enclosures are for indoor or outdoor use.

Warranty void if panel is modified.



Call factory with servicing questions:
1-800-543-2550

Liberty Pumps offers a three-year limited warranty.
For complete terms and conditions, please visit www.libertypumps.com.

Products returned must be cleaned, sanitized, or decontaminated as necessary prior to shipment to ensure that employees will not be exposed to health hazards in handling said material. All applicable laws and regulations shall apply.

© 2019 SJE, Inc. All Rights Reserved.
SJE RHOMBUS is a trademark of SJE, INC.
PN 1038909E • Rev 08/19

Installing the Float Switches

The Three Phase Duplex control panel operates with float switches to activate pump STOP, LEAD pump START, LAG pump START and high-level ALARM functions.

1 **⚠ WARNING!**

Ensure all power is turned OFF before installing floats in tank. Failure to do so could result in serious or fatal shock.

2 Label each float and cord end with the provided pairs of STOP, LEAD, LAG, and ALARM stickers.

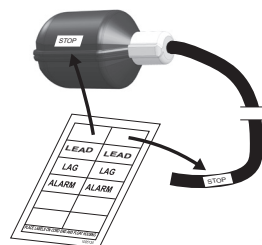
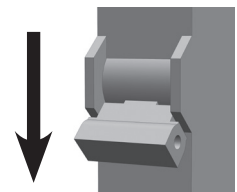

3 **⚠ CAUTION!**

If the floats are not properly mounted and connected in the correct order, the pumps will not function properly.

Floats require free range of motion.

They must not touch each other or any equipment in the pump chamber.

Pipe Clamp Mounting

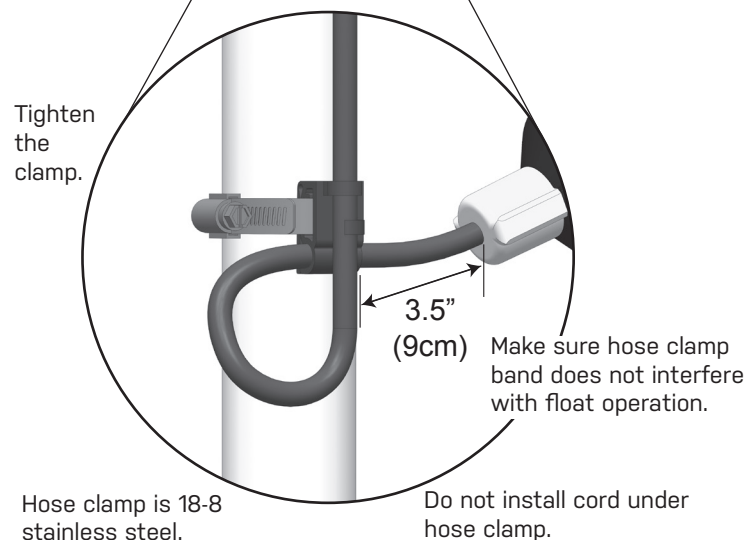
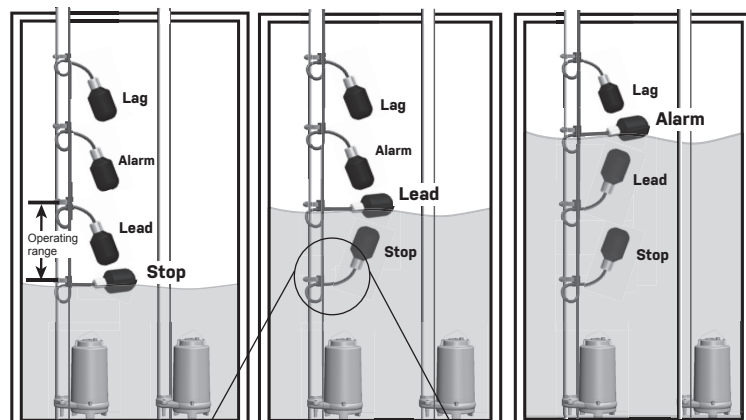

Mounting the Control Panel

NOTE

If the distance to the control panel exceeds the length of the float switch cords or the pump power cord, splicing in a liquid-tight junction box will be required. For outdoor or wet installation, we recommend a Liberty Pumps UL Type 4X junction box.

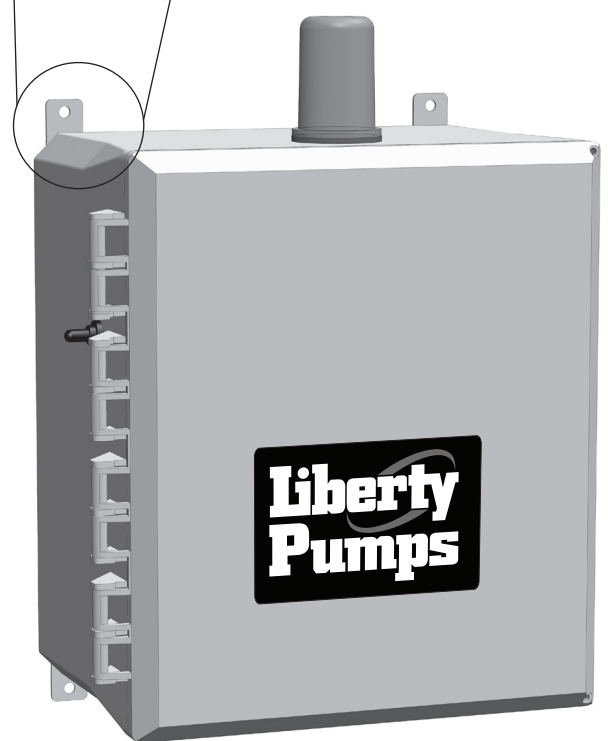
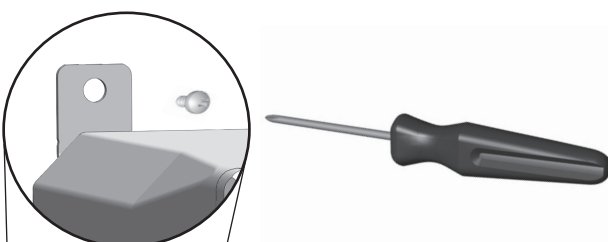

Wiring the Control Panel

1 Determine conduit entrance locations on control panel as shown. Check local codes and schematic on the inside cover of the panel for the number of power circuits required.

⚠ CAUTION!

Be sure the pump power voltage and phase are the same as the pump motor being installed.

2 Connect the following wires to the proper terminal positions:

- incoming power
- pump 1
- pump 2
- float switches

See schematic on inside cover of the control panel for details.

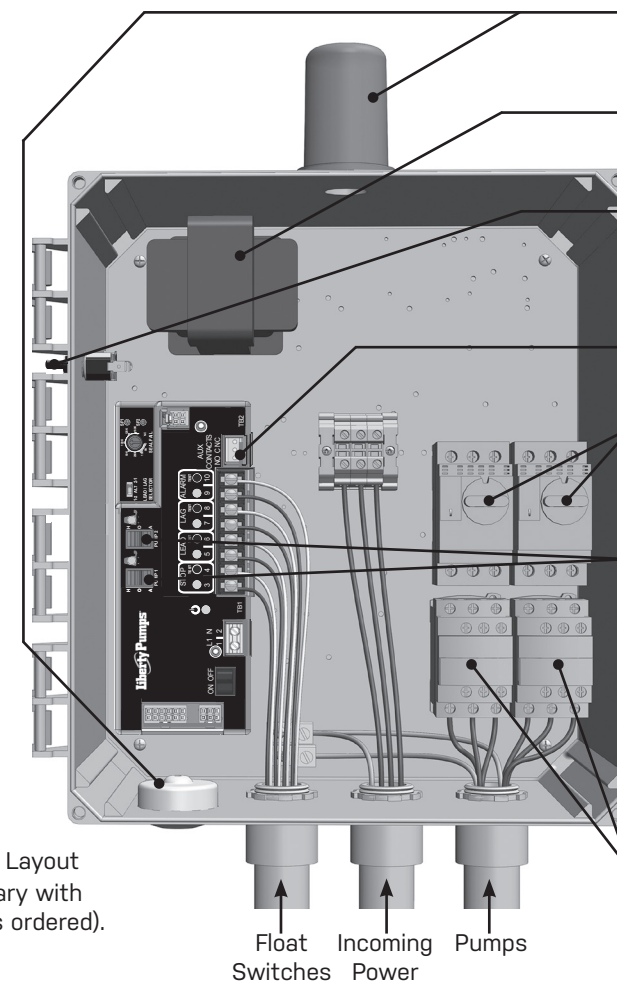

Typical Layout
(May vary with options ordered).

Float Switches Incoming Power Pumps

⚠ CAUTION! You must use conduit sealant to prevent moisture or gases from entering the panel.

Type 4X conduit must be used to maintain a Type 4X rating of the control panel.

3 Verify correct operation of control panel after installation is complete.

Operation

Liberty Pumps Three Phase Duplex control panel operates with float switches. When all floats are in the open or OFF position, the panel is inactive. As the liquid level rises and closes the STOP float, the panel remains inactive until the LEAD float closes. At this point the LEAD pump will turn ON (if the Hand-Off-Auto switch is in the AUTO mode and the power is ON). The pump will remain ON until both the STOP and LEAD floats return to their OFF positions. If the liquid level rises beyond both the STOP and LEAD floats to reach the LAG float, the lag pump will turn ON (if the Hand-Off-Auto switch is in the AUTO mode and the power is ON). Both pumps will remain ON until the STOP, LEAD, and LAG floats return to their OFF positions. If the liquid level rises to reach the ALARM float, the alarm will be activated.

Alarm System (Indicator Light and Horn)

When an alarm condition occurs, the red light and horn will be activated.

Transformer

The transformer converts incoming three phase power to 120V to be used for control and alarm.

If the **TEST/NORMAL/SILENCE** switch is moved to the SILENCE position and released, the horn will be silenced. When the alarm condition is cleared, the alarm system is reset.

Auxiliary Contact

Form C - Can be wired normally open or normally closed.

Motor Protective Switches

Each pump circuit has motor protective switches that provides pump disconnect, overload, and branch circuit protection. Adjust overload to pump FLA.

Hand-Off-Auto (HOA) Switches

The HOA 3-way switches control pump functions.

HAND In HAND mode, the pump will turn ON.

OFF OFF turns the pump OFF.

AUTO In AUTO mode, commands from the float switches turn each pump ON and OFF.

Motor Contactors

Motor contactors control pumps by switching electrical lines.

? Technical support, service questions:
1-800-543-2550

Monday - Friday
7:00 AM to 6:00 PM Eastern Time