

Zoning

**532\_D**

02/15

Replaces: New

## Installation & Operation Manual

### Introduction

The tekmarNet<sup>®</sup> Thermostat 532 is a communicating thermostat designed for one stage hydronic heating systems. Simple up and down buttons and a display with large type make this thermostat easy to read and use. It has two auxiliary sensor inputs that can be assigned to measure room, floor, or outdoor temperature. An optional floor sensor protects the floor from overheating and enhances comfort. The 532 can be wired using 2 or 4 wires to connect to tekmarNet zoning controls, or can be installed as a stand-alone thermostat using 3 wires.

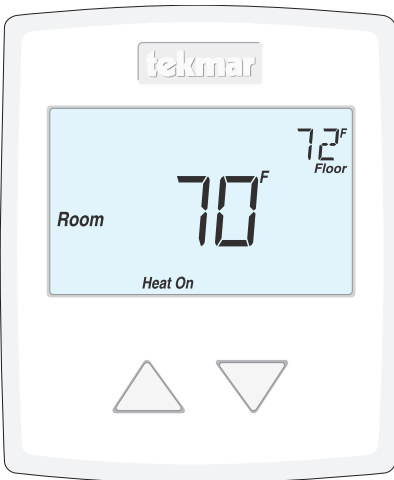

### Features

- tekmarNet communication compatible
- Radiant floor heating
- Floor & air temperature control
- Zone synchronization
- Network schedule member
- Optimum start
- Away scene
- Air group member
- 2 auxiliary sensor inputs
- Backlight
- Room temperature limiting

## Table of Contents

Getting Started .....	2
Important Safety Information .....	3
Installation .....	4
Preparation .....	4
Removing The Thermostat Base .....	4
Mounting The Thermostat .....	5
Thermostat Wiring .....	6
Testing the Thermostat Wiring .....	8
Switch Settings .....	9
User Interface .....	10
Home Screen .....	10
Symbols Description .....	10
Sequence of Operation .....	11
Heating Operation .....	11
Air Group Operation .....	13
Schedules .....	13
Scenes (System Override) .....	14
tekmarNet® Address .....	14
Lock/Unlock And Access Levels .....	14
Programmable Settings .....	15
Troubleshooting .....	17
Error Messages .....	17
Technical Data .....	19
Limited Warranty and Product Return Procedure .....	20

## Getting Started

Congratulations on the purchase of your new tekmar® thermostat.

This manual will step through the complete installation, programming and sequence of operation for this control. At the back, there are tips for control and system troubleshooting.

## Important Safety Information

It is your responsibility to ensure that this thermostat is safely installed according to all applicable codes and standards. tekmar is not responsible for damages resulting from improper installation and/or maintenance.



This is a safety-alert symbol. The safety alert symbol is shown alone or used with a signal word (DANGER, WARNING, or CAUTION), a pictorial and/or a safety message to identify hazards.

When you see this symbol alone or with a signal word on your equipment or in this Manual, be alert to the potential for death or serious personal injury.



This pictorial alerts you to electricity, electrocution, and shock hazards.

### **WARNING**

This symbol identifies hazards which, if not avoided, could result in death or serious injury.

### **CAUTION**

This symbol identifies hazards which, if not avoided, could result in minor or moderate injury.

### **NOTICE**

This symbol identifies practices, actions, or failure to act which could result in property damage or damage to the equipment.

### **WARNING**



Read Manual and all product labels BEFORE using the equipment. Do not use unless you know the safe and proper operation of this equipment. Keep this Manual available for easy access by all users. Replacement Manuals are available at [tekmarControls.com](http://tekmarControls.com)

### **WARNING**

- It is the installer's responsibility to ensure that this thermostat is safely installed according to all applicable codes and standards.
- Improper installation and operation of this thermostat could result in damage to the equipment and possibly even personal injury or death.
- This thermostat is not intended for use as a primary limit control. Other controls that are intended and certified as safety limits must be placed into the control circuit.

### **NOTICE**

Do not attempt to service the thermostat. There are no user serviceable parts inside the thermostat. Attempting to do so voids warranty.

# Installation

## Preparation

### Tools Required

- tekmar or jeweller screwdriver
- Phillips head screwdriver
- Wire stripper
- Drill (for wall anchor)
- 3/16" drill bit (for wall anchor)

### Materials Required

- 18 AWG LVT Solid Wire  
(Low Voltage Connections)

### Installation Location

Choose the placement of the thermostats early in the construction process to enable proper wiring during rough-in.

### NOTICE

Consider the following:

- Interior Wall.
- Keep dry. Avoid potential leakage onto the control.
- Relative Humidity less than 90%. Non-condensing environment.
- No exposure to extreme temperatures beyond 32-122°F (0-50°C).
- No draft, direct sun, or other cause for inaccurate temperature readings.
- Away from equipment, appliances, or other sources of electrical interference.
- Easy access for wiring, viewing, and adjusting the display screen.
- Approximately 5 feet (1.5 m) off the finished floor.
- The maximum length of wire is 500 feet (150 m).
- Strip wire to 3/8" (10 mm) for all terminal connections.
- Use standard 8 conductor, 18 AWG wire.

## Removing The Thermostat Base

To remove the thermostat base:

- Locate the tab on the bottom of the thermostat.
- Push the tab with either your thumb or with a screwdriver.
- Lift the thermostat front away from the thermostat's base.

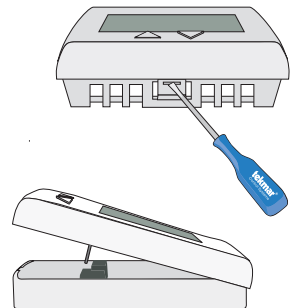

## Mounting The Thermostat

### ⚠ WARNING



To prevent the risk of personal injury and/or death, make sure power is not applied to the thermostat until it is fully installed and ready for final testing. All work must be done with power to the circuit being worked on turned off.

Please be aware local codes may require this thermostat to be installed or connected by an electrician.

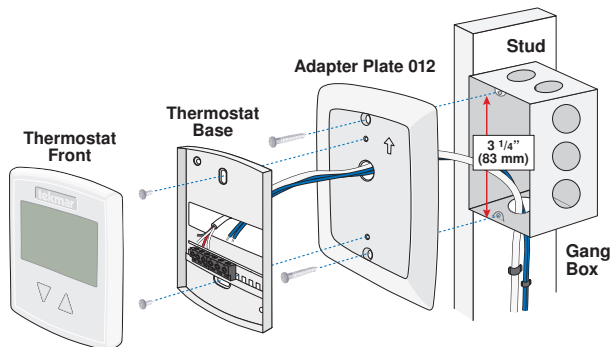

If a single gang box is used:

- Adapter Plate 012 is required (sold separately).
- Feed the wiring through the hole in the adaptor plate and the thermostat base.
- Fasten the adaptor plate to the gang box.
- Fasten the base of the thermostat to the adaptor plate.
- Terminate wiring to the wiring strip. Do not over tighten wiring screws. Hand tighten only.
- Push the thermostat front onto the thermostat base.

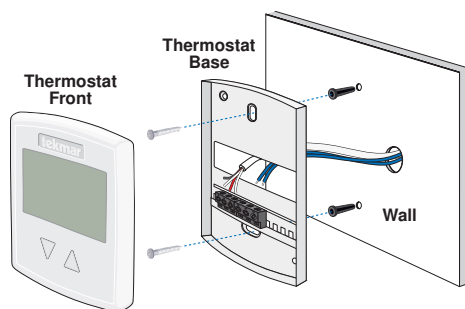

If mounting directly to the wall:

- Drill holes using a 3/16" drill bit and install the wall anchors.
- Feed the wiring through the large hole in the thermostat base.
- Fasten the thermostat base to the wall using the wood screws to the wall anchors.
- Terminate wiring to the wiring strip. Do not over tighten wiring screws. Hand tighten only.
- Push the thermostat front onto the thermostat base.

# Thermostat Wiring

## tekmarNet®2 - Wiring Center 313 or 314

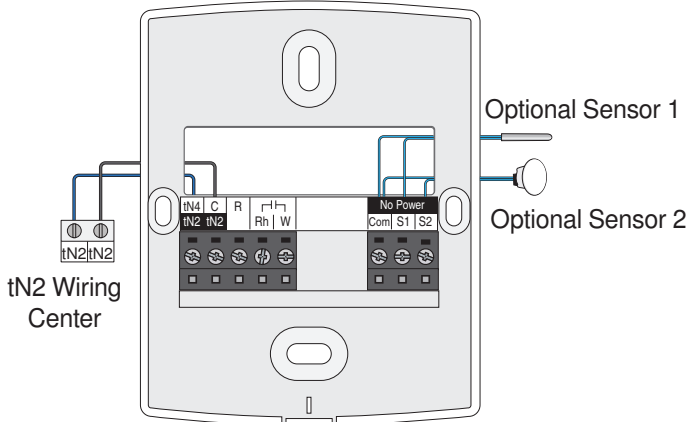

## tekmarNet®4 - Wiring Center 315 or 316

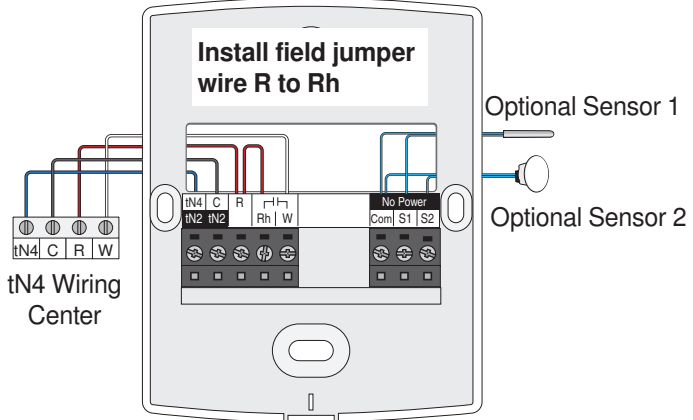

## Zone Valve

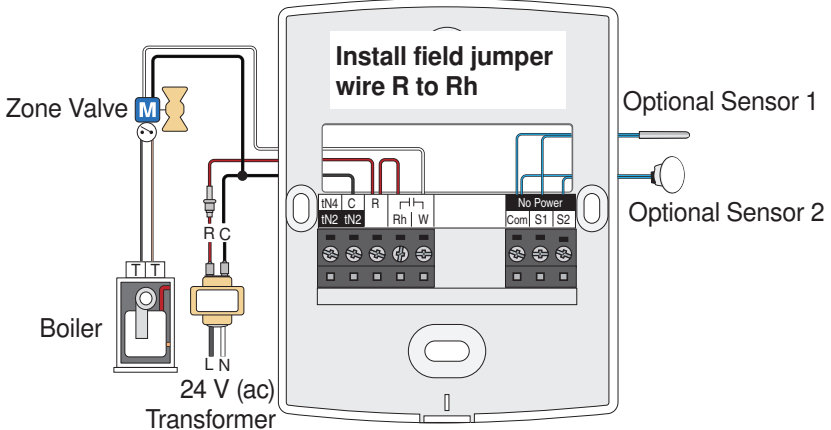

# Thermostat Wiring

## Switching Relay

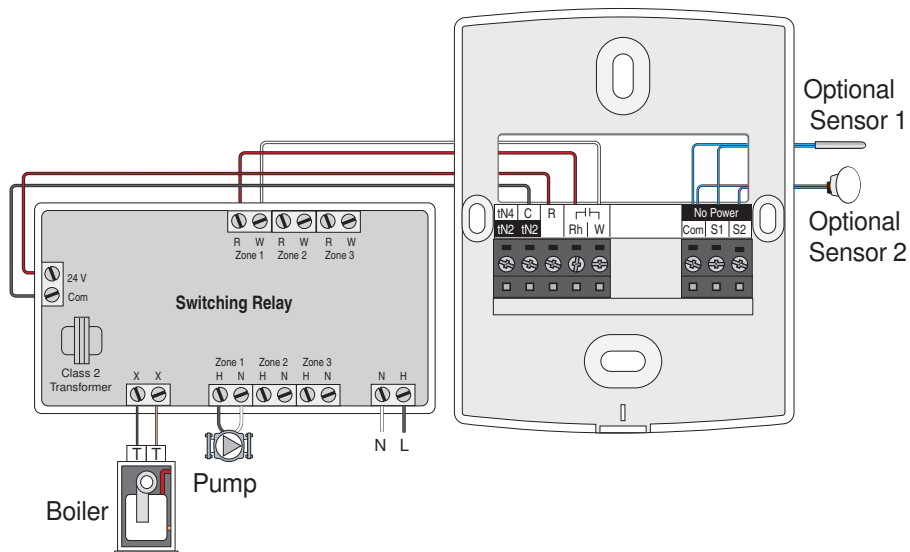

## Relay 003

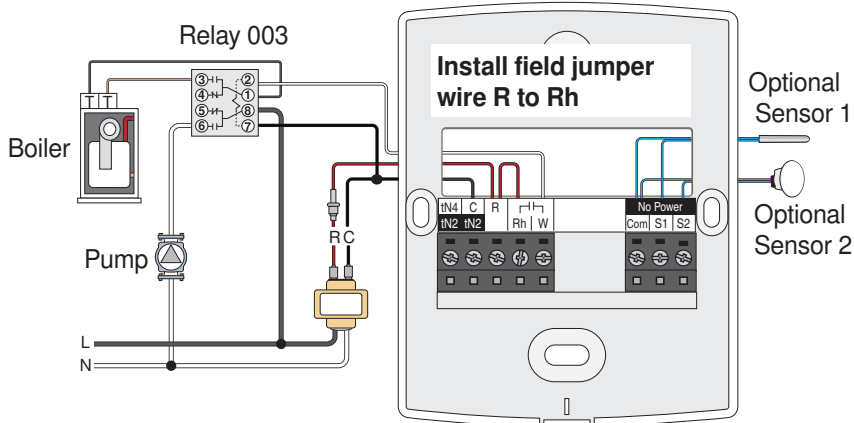

Available auxiliary sensors:

- Outdoor Sensor 070
- Slab Sensor 072 20' (6 m) wire
- Slab Sensor 073 40' (12 m) wire
- Indoor Sensor 076
- Indoor Sensor 077 *Cover Plate*
- Slab Sensor 079 10' (3 m) wire
- Indoor Sensor 084 *Flush Mount*

## Testing the Thermostat Wiring

### CAUTION

Only qualified personnel should perform testing procedures. A licensed electrician is recommended.

### Testing tN2 Wiring



It is normal for the thermostat to take up to 20 seconds to power on once connected to a tN2 system. If the thermostat display does not turn on after 20 seconds, try moving the thermostat tN2 wire connections to another zone on the tN2 Wiring Center or tN2 Zone Manager. If the thermostat display does not power on, contact your tekmar sales representative for assistance.

### Testing tN4 and Stand Alone Wiring

#### Power

If the thermostat display does not power on, remove the thermostat front and test for 24 V(ac)  $\pm 10\%$  between the R and C wiring terminals. If the voltage is incorrect, check the voltage at the transformer. If the transformer measures 24 V(ac)  $\pm 10\%$  between the R and C, then there may be an open circuit along the wires. If the thermostat display turns off when powering the heat relay and the load, then the transformer VA capacity is too small and a larger transformer is required.

#### Heat Relay

Push the  button and set the temperature below the current room or floor temperature. There should be no "Heat On" symbol on the display. Measure the voltage on the heating equipment (wiring center, zone valve or relay). The voltage measure 0 V(ac). Then push the  button and set the temperature above the current room or floor temperature. The "Heat On" symbol should appear. Make sure that the display does not show "WWSD" or "Max" which limit the operation of the heat relay. Measure the voltage on the heating equipment (wiring center, zone valve or relay). The voltage should measure 24 V (ac). If there is no voltage check to insure that any necessary jumper wires are installed and check the wires for open or short circuits.

#### tN4 Communication

The  symbol is shown on the display when communication is present. If the thermostat is connected in a network and the communication is missing, there may be an open or short circuit on the tN4 and C bus wires.



# Switch Settings

The switch settings are located on the rear of thermostat face.

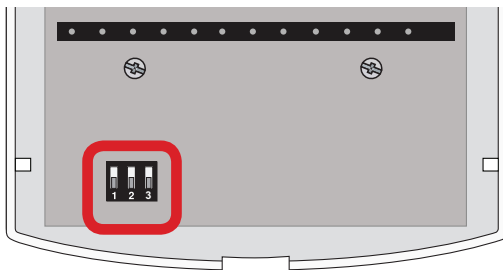

Switch	Position	Action
1	ON	<b>SETBACK</b> The thermostat follows a programmable setback schedule as a schedule member if available. Requires the installation of a Thermostat 552, 553, 554, 557 or a Timer 033 to use this feature.
	OFF	<b>OFF</b> The thermostat does not follow a programmable setback schedule.
2	ON	<b>SCENE</b> The thermostat responds to changes in the scene (systemwide manual overrides). Requires the installation of a Gateway or User Switch to use this feature.
	OFF	<b>OFF</b> The thermostat does not respond to scenes.
3	ON	<b>LOCK ACCESS LEVEL</b> Some Setup menu settings are not visible. Set to Unlock during installation process. tekmarNet <sup>®</sup> reset control must also be set to Unlocked and Installer access level.
	OFF	<b>UNLOCK ACCESS LEVEL</b> All Setup menu settings are available. Set to Lock when installation completed.

# User Interface

## Home Screen

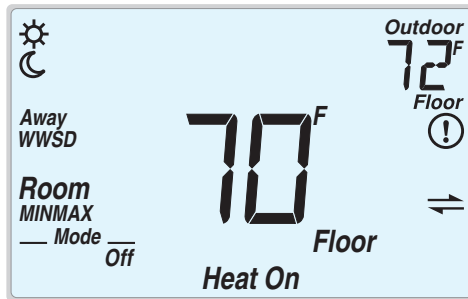

## Symbols Description

<b>Heat On</b>	<b>HEAT ON</b> Heat is turned on.	<b>WWSD</b>	<b>WWSD</b> Warm Weather Shut Down.
<b>—MODE—</b> <b>Off</b>	<b>MODE OFF</b> The heating system is off.		<b>WARNING SYMBOL</b> Indicates an error is present.
	<b>SUN</b> Operating at the occupied (day) temperature.	<b>Away</b>	<b>SCENE AWAY</b> Operating at Away temperature.
	<b>MOON</b> Operating at the unoccupied (night) temperature.		<b>tekmarNet®</b> Communication is present.
<b>MIN</b>	<b>MIN</b> Flashes when adjusting temperature and the floor is at or below the floor minimum temperature.	<b>MAX</b>	<b>MAX</b> Flashes when adjusting temperature and the floor has reached the floor maximum temperature.

# Sequence of Operation

## Heating Operation

To change the heat temperature setting, push the  $\Delta$  or  $\nabla$  button to select a preferred temperature setting. The Heat On symbol is shown on the display when the thermostat is heating. The heat can cycle on and off within  $\pm 1.5^\circ\text{F}$  ( $1^\circ\text{C}$ ) of the temperature setting. The floor and air heating can be shut off by holding the  $\nabla$  button until Set Room is Off. To resume heating when the Mode is Off, press the  $\Delta$  button to navigate to the Mode setting, then press the  $\Delta$  button to select Mode Heat. The thermostat will resume heating at the last previously set temperature.

## Air Temperature Only

If there is only an air temperature sensor (no floor sensor), the thermostat operates to control your desired air temperature.

## Floor Temperature Only

If the air sensor has been disabled, the thermostat will only maintain floor temperature and ignore air temperature. This operation is recommended for areas such as bathrooms to ensure that tile floors are warm to the touch.

## Floor and Air Temperature

If the air sensor is turned on and a floor sensor is connected, the thermostat will maintain the desired air temperature as well as a minimum floor temperature.

This operation is recommended for areas with large windows that allow the sun to shine into a room and keep it warm without the need for heating. This can allow the floors to cool off during the afternoon. When the sun goes down, it can take a long time for the floors to get warm again. This may cause the room to cool off too much in the early evening. A floor minimum setting can help with this condition by maintaining a floor minimum temperature. Keep in mind the floor minimum temperature will override the air temperature, and if set too high, may overheat the room.

This operation is also recommended for rooms with hardwood floors. Setting floor minimum and maximum temperatures is a way of enhancing the comfort of the living space while protecting floor coverings.

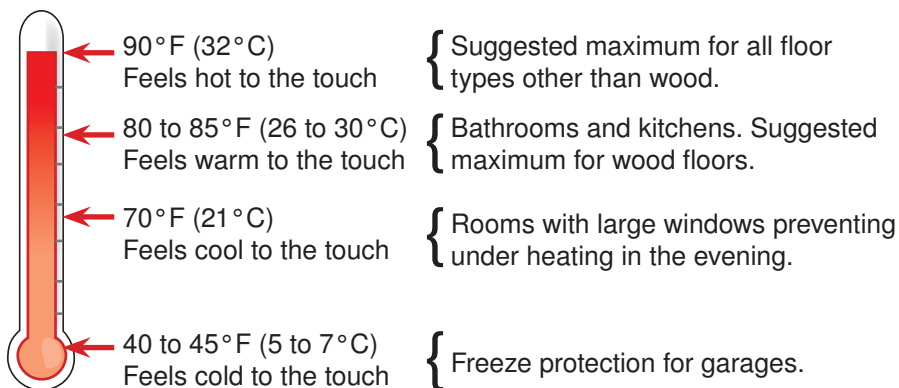

## Room Minimum and Maximum

---

Room Minimum and Maximum temperature settings are available in the Setup menu. These allow the installer to select start and stop limits for the temperature setting. This is useful in commercial installations and child or guest bedrooms where availability of the full temperature setting range may not be desirable.

## Warm Weather Shut Down

---

When the outdoor air temperature exceeds the Warm Weather Shut Down (WWSD) setting on the tekmarNet main control, the heating system is shut off.

## Freeze Protection

---

The thermostat operates the heat whenever the room or floor temperature falls below 40°F (4.5°C) even when the mode is set to off.

## Exercising

---

When connected to a tekmarNet system control, the thermostat exercises the heat relay for 10 seconds every 3 days. Exercising helps prevent zone valves or zone pumps from failing due to precipitate buildup. During exercising, the relay turns on but is not shown on the display.

## Flushing

---

The flushing feature is for open-loop systems that use a domestic hot water tank as a heat source. Flushing ensures that fresh potable water is circulated through the system once each day. If the thermostat is connected to a tekmarNet system control with the flushing feature turned on, the relay turns on but is not shown on the display.

## Hydronic System Supply Pump

---

When connected to a tekmarNet system control, the thermostat's W Pump setting affects how the primary pump or mix pump on the system control operates. When connected to the boiler bus, the boiler system or primary pump is operated when W Pump is set to on. When connected to the mix bus, the mix system pump is operated when W Pump is set to on.

If the thermostat operates a thermal motor (wax actuator) zone valve, set the W Delay setting to on. This provides a three-minute delay to allow the zone valve to open before the primary or mix pump is turned on.

In special applications with multiple zoning manifolds, the W Pump setting can be set to off. This allows a Zone Group Pump located on the Zone Manager or Wiring Center to operate the pump for the manifold.

## DHW Tank Priority

---

When a tekmarNet® system control is heating an indirect Domestic Hot Water (DHW) tank, the thermostat may shut off the heating zones to allow the DHW tank to recover quickly. This is determined by the DHW priority of the tekmarNet system control.

## Air Group Operation

In order to prevent heating and cooling at the same time, this thermostat can operate together with other thermostats on a tekmarNet system to form an air group.

In an air group, a heat-cool thermostat is assigned as the air group master. The air group master operates the cooling and air heating equipment for the group. The 532 can be set to be a member of the air group.

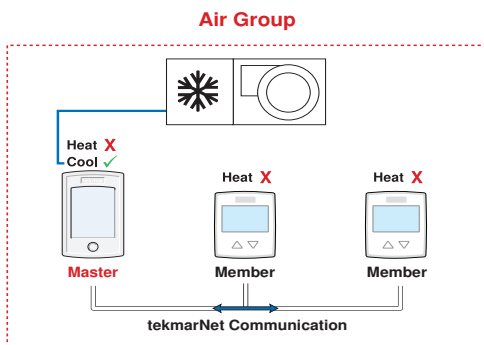

When operating as an air group, the air temperature readings of all the air group member thermostats are communicated to the air group master thermostat and an average temperature is determined.

When the air group master is in cooling operation, the air group member thermostats do not operate the heating system for air heating. Once the cooling system shuts off, heating is available if required.

Some air group master thermostats have the ability to prevent radiant floor heating while the air heating system is operating during mild outdoor temperatures. Once the outdoor temperature falls below the first stage warm weather shut down setting, the air group member thermostats are allowed to heat if required.

## Schedules

Lowering the room temperature setting reduces the amount of fuel required to heat the building, resulting in energy savings.

This thermostat can follow a programmable schedule in order to automatically lower the room temperature setting. A schedule master such as a Timer 033 or a programmable tekmarNet thermostat 552, 553, 554 or 557 is required in order to gain programmable schedule functionality.

When operating on a programmable schedule, a ☀ or a ☾ is shown on the display.

Display	Action
☀	Programmable schedule at occupied temperature.
☾	Programmable schedule at unoccupied temperature.





When a programmable schedule is selected, there is a time delay for the temperature in the room to change from the ☾ temperature to the ☀ temperature.



When a schedule is set, the thermostat uses Optimum Start to predict the heat up and cool off rate of the room. The optimum start feature allows the room to reach the set room ☀ temperature by the time set in the programmable schedule.

## Scenes (System Override)

Scenes provide an easy way to save energy while away on vacation, or override a pre-set schedule when plans change. tekmarNet® devices such as a User Switch 479 provide scene adjustment.

This thermostat responds to the following scenes:

Scene	Display	Room Temperature Setting
1		Follows the programmable schedule or operates at the occupied  temperature
2	<b>Away</b>	Away temperature
3		Unoccupied  temperature

While in the Away scene, the room temperature cannot be changed using the  $\Delta$  or  $\nabla$  button. Change the scene from Away to  or  to change the temperature.

## tekmarNet® Address

When connected to a tekmarNet® system, each thermostat will be automatically given an address. The address is useful as a troubleshooting tool to locate thermostats with errors and also allows room naming on a Gateway.

The address consists of the bus water temperature followed by the thermostat device number. Available buses are b (boiler), 1, 2 and 3. Device numbers range from 01 to 24. If the thermostat is used without a tekmarNet® system control, the bus number is not shown.

When using the thermostat together with a Gateway, it is important that each address be manually set. This allows each thermostat to be named on the Gateway.

If two thermostats are manually set to the same address, an error message will appear. The error remains until one of the addresses is manually changed to a vacant address or to Auto.

It is highly recommended to keep a documented list of thermostat addresses. This is extremely helpful when troubleshooting errors. The tekmarNet® system control will display addresses of thermostats that have errors. Referring to the address documentation simplifies the process to locate and correct errors.

## Lock/Unlock And Access Levels



The thermostat can be either locked or unlocked. When locked, there are fewer settings available in the Setup menu. There are two locations to lock the thermostat:

- 1) Locally on the back of the thermostat using the Lock switch
- 2) Globally on the tekmarNet® system control using the Lock switch or Access Level set to User.

Both the local and global lock settings must be set to unlock before all thermostat settings are available. Once installation is complete, it is recommended to lock the thermostat.

# Programmable Settings





Setting	Range	Default
<p>The following settings are available when the thermostat is <b>locked</b> or <b>unlocked</b>.  <b>Press the <math>\Delta</math> and <math>\nabla</math> buttons together for 3 seconds</b> to enter and advance to the next setting.</p>		
<p><b>MODE</b>            Select heat or off.</p>	Heat, Off	Heat
<p><b>SET ROOM <math>\star</math></b>            Set the room temperature while in the occupied time period. Available when a room sensor is connected.</p>	40 to 95°F (4.5 to 35.0°C)	70°F (21.0°C)
<p><b>SET ROOM <math>\text{C}</math></b>            Set the room temperature while in the unoccupied time period. Available when a room sensor is connected and a schedule or scenes are selected.</p>	40 to 95°F (4.5 to 35.0°C)	65°F (18.5°C)
<p><b>SET ROOM AWAY</b>            Set the room temperature while in the away scene. Available when a room sensor is connected and a schedule or scenes are selected.</p>	40 to 95°F (4.5 to 35.0°C)	62°F (16.5°C)
<p><b>SET FLOOR <math>\star</math></b>            Set the floor temperature while in the occupied time period. Available when an auxiliary floor sensor is connected.</p>	Off, 40 to 122°F (Off, 4.5 to 50.0°C)	72°F (22.0°C)
<p><b>SET FLOOR <math>\text{C}</math></b>            Set the floor temperature while in the unoccupied time period. Available when an auxiliary floor sensor is connected and the schedule or scenes switch settings are on. "Off" is the factory default when there are both room air and floor temperature sensors.</p>	Off, 40 to 122°F (Off, 4.5 to 50.0°C)	65°F (18.5°C) or Off
<p><b>LIGHT</b>            Select when the display backlight should operate. Auto operates the backlight for 30 seconds after a keystroke. Sun turns on the backlight</p>	Off, Auto, Sun, On	Auto
<p><b>UNITS</b>            Select the temperature units.</p>	°F or °C	°F
<p><b>TYPE AND SOFTWARE VERSION</b>            Device Type number. Hold the <math>\Delta</math> button to view the software version and view any system overrides.  <b>W OVR ON:</b> Heat relay is on for purging, exercising, flushing  <b>W OVR OFF:</b> Heat relay is off for DHW or setpoint priority  <b>OPT START:</b> Optimum start is in effect.  <b>AIR MASTR:</b> Heat relay is off because air group master thermostat is cooling or W1 Warm Weather Shut Down in effect.</p>	N/A	532
<p><b>ADDRESS</b>            The tekmarNet® address is shown in the large number field. The address and "Auto" are alternated when using automatic addressing.</p>	Auto, 01 to 24, b:01 to b:24, 1:01 to 3:24	Auto



Setting	Range	Default
<b>SCHEDULE</b> The thermostat can follow a shared network schedule. Select to follow either schedule master 1, 2, 3 or 4. Requires tekmarNet.	1 to 4	1
The following additional settings are available when the thermostat is <b>unlocked</b> .		
<b>SET LIMIT ROOM MAX ☼</b> Set the max room temperature limit while in the occupied time period. Available when a room sensor is connected.	40 to 95°F (4.5 to 35.0°C)	95°F (35.0°C)
<b>SET LIMIT ROOM MAX ☾</b> Set the max room temperature limit while in the unoccupied time period. Available when a room sensor is connected and a schedule or scenes are selected.	40 to 95°F (4.5 to 35.0°C)	95°F (35.0°C)
<b>SET LIMIT ROOM MIN</b> Set the min room temperature limit for both occupied and unoccupied time periods. Available when a room sensor is connected, and schedule or scenes are selected.	40 to 95°F (4.5 to 35.0°C)	40°F (4.5°C)
<b>SET FLOOR MAX</b> Set the max floor temperature in order to protect the floor covering. Available when an auxiliary floor sensor is connected. Suggested settings: Tile = 90°F (32°C), Wood Floor = 85°F (29°C)	Off, 40 to 122°F (Off, 4.5 to 50.0°C)	85°F (29.5°C)
<b>SENSOR 1</b> Select the type of sensor connected to auxiliary input 1. Available when a sensor is automatically detected.	None, Room, Flor, Out	Flor
<b>SENSOR 2</b> Select the type of sensor connected to auxiliary input 2. Available when a sensor is automatically detected.	None, Room, Flor	Room
<b>ROOM SENSOR</b> Select if the built-in room temperature sensor is on or off. The built-in room sensor can only be disabled when an auxiliary room or floor sensor is connected.	Off or On	On
<b>AIR GROUP</b> Select if this thermostat should be included in an air group to interlock heating and cooling for the group. Requires tekmarNet.	Off, 1 to 16	Off
<b>W PUMP</b> During a heat call, select whether or not the tN4 system control's pump should turn on or be off to allow a zone group pump per manifold. Requires a tekmarNet System Control.	Off or On	On
<b>W DELAY</b> During a heat call, select whether or not the tN4 system control's pump should be delayed by 3 minutes to allow manifold thermal actuator zone valves to open. Requires a tekmarNet System Control.	Off or On	Off
<b>ESCAPE</b> Release the  and  buttons to return to the home screen.		



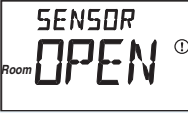
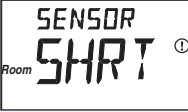
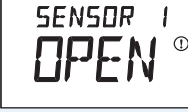
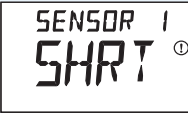
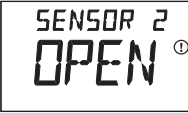

# Troubleshooting

## Error Messages

Error Message	Description
	<b>SETUP MENU SAVE ERROR</b> The thermostat failed to read the programmable settings from memory and has reloaded the factory default settings. The thermostat operates on the factory defaults settings to ensure the building does not freeze. To clear the error, set the switch settings to unlock and go through all the settings in the Programmable Setting menu.
	<b>tN2 PORT ERROR</b> The thermostat has been connected to a tN2 zone already in use by a 2-stage zoning control. A 2-stage device requires two tN2 ports to operate. To clear the error, move the thermostat's tN2 wires to an unused tN2 port on the zoning control.
	<b>tekmarNet ERROR</b> The tekmarNet communication bus has either an open or a short circuit. The result is that there are no communications. Check for loose wires between tN4 and C. Check for short circuits between the tN4 and C wires on the House Control, Wiring Center, or Zone Manager. Check for correct polarity between the C and R wires. The error clears automatically once the wiring fault has been corrected. To force the error to clear while allowing a short or open circuit to continue, push and hold the Up and Down buttons together.
	<b>ADDRESS ERROR</b> Two thermostats have been manually set to the same address. The thermostat continues to operate with this error but does not communicate with the tekmarNet system. To clear this error, select an unused tekmarNet address or select automatic addressing.
	<b>DEVICE LIMIT ERROR</b> More than 24 devices (thermostats, setpoint and snow melting controls) have been connected to the tekmarNet communication bus. To clear the error, remove and relocate devices to other available buses until the device count is 24 or less.

Error Message	Description
 <p>The error message shows the text "ROOM SENSOR OPEN" in a stylized font. "ROOM" is in small letters to the left of "SENSOR". "OPEN" is in large letters. A circled "1" is to the right of "OPEN".</p>	<p><b>ROOM SENSOR OPEN CIRCUIT ERROR</b>  The built-in air temperature sensor has an open circuit fault. Do not confuse this error with the auxiliary room sensor short circuit error. This error cannot be field repaired. Contact your wholesaler or tekmar sales representative for details on repair procedures.</p>
 <p>The error message shows the text "ROOM SENSOR SHRT" in a stylized font. "ROOM" is in small letters to the left of "SENSOR". "SHRT" is in large letters. A circled "1" is to the right of "SHRT".</p>	<p><b>ROOM SENSOR SHORT CIRCUIT ERROR</b>  The built-in air temperature sensor has a short circuit fault. Do not confuse this error with the auxiliary room sensor short circuit error. This error cannot be field repaired. Contact your wholesaler or tekmar sales representative for details on repair procedures.</p>
 <p>The error message shows the text "SENSOR 1 OPEN" in a stylized font. "1" is in large letters to the right of "SENSOR". "OPEN" is in large letters. A circled "1" is to the right of "OPEN".</p>	<p><b>SENSOR 1 OPEN CIRCUIT ERROR</b>  Auxiliary sensor 1 has an open circuit. Check for loose or damaged wires. Locate and repair the problem as described in the sensor Installation &amp; Operation Manual (070_D, 079_D). The error clears once the auxiliary sensor 1 fault is corrected. If the sensor was intentionally removed, power the thermostat down and up to clear the error.</p>
 <p>The error message shows the text "SENSOR 1 SHRT" in a stylized font. "1" is in large letters to the right of "SENSOR". "SHRT" is in large letters. A circled "1" is to the right of "SHRT".</p>	<p><b>SENSOR 1 SHORT CIRCUIT ERROR</b>  Auxiliary sensor 1 has a short circuit. Check for damaged wires. Locate and repair the problem as described in the sensor Installation &amp; Operation Manual (070_D, 079_D). The error clears after the auxiliary sensor 1 fault is corrected.</p>
 <p>The error message shows the text "SENSOR 2 OPEN" in a stylized font. "2" is in large letters to the right of "SENSOR". "OPEN" is in large letters. A circled "1" is to the right of "OPEN".</p>	<p><b>SENSOR 2 OPEN CIRCUIT ERROR</b>  Auxiliary sensor 2 has an open circuit. Check for loose or damaged wires. Locate and repair the problem as described in the sensor Installation &amp; Operation Manual (070_D, 079_D). The error clears once the auxiliary sensor 2 fault is corrected. If the sensor was intentionally removed, power the thermostat down and up to clear the error.</p>
 <p>The error message shows the text "SENSOR 2 SHRT" in a stylized font. "2" is in large letters to the right of "SENSOR". "SHRT" is in large letters. A circled "1" is to the right of "SHRT".</p>	<p><b>SENSOR 2 SHORT CIRCUIT ERROR</b>  Auxiliary sensor 2 has a short circuit. Check for damaged wires. Locate and repair the problem as described in the sensor Installation &amp; Operation Manual (070_D, 079_D). The error clears after the auxiliary sensor 2 fault is corrected.</p>
 <p>The error message shows the text "AIR GROUP LOST" in a stylized font. "AIR GROUP" is in small letters to the left of "LOST". "LOST" is in large letters. A circled "1" is to the right of "LOST".</p>	<p><b>AIR GROUP MEMBER ERROR</b>  The thermostat can no longer detect its air group or cooling group master thermostat through the tekmarNet system. To clear the error, either select a heat-cool thermostat to be the air group master or set this thermostat's air group member setting in the programmable settings to None.</p>

Error Message	Description
	<b>INTERNAL ERROR</b> The thermostat has an internal fault. This error cannot be field repaired. Contact your wholesaler or tekmar sales representative for details on repair procedures.
	<b>POWER</b> The thermostat power supply voltage on wiring terminals R and C is too low. The thermostat does not operate until the voltage is increased to 24 V (ac).

## Technical Data

<b>tekmarNet<sup>®</sup> Thermostat 532 One Stage Heat</b>	
Literature	532_C, 532_D, 532_Q, 532_U
Control	Microprocessor control. This is not a safety (limit) control.
Packaged weight	0.53 lb. (240 g)
Dimensions	3-11/16" H x 3" W x 15/16" D (94 x 76 x 24 mm)
Enclosure	White PVC plastic, NEMA Type 1
Approvals	Meets Class B: ICES & FCC Part 15
Ambient conditions	Indoor use only, 32 to 122°F (0 to 50°C), RH ≤90% non-condensing
Power supply	24 V ± 10%, 50/60 Hz, 1.8 VA standby, Class 2
Relays	24 V (ac/dc), 2 A, Class 2 circuits
Sensor	NTC thermistor, 10 kΩ @ 77°F (25°C ±0.2°C) β=3892
– Included	None
– Optional	tekmar type # 070, 072, 073, 076, 077, 079, 084

## Limited Warranty and Product Return Procedure

**Limited Warranty** *The liability of tekmar under this warranty is limited. The Purchaser, by taking receipt of any tekmar product ("Product"), acknowledges the terms of the Limited Warranty in effect at the time of such Product sale and acknowledges that it has read and understands same.*

The tekmar Limited Warranty to the Purchaser on the Products sold hereunder is a manufacturer's pass-through warranty which the Purchaser is authorized to pass through to its customers. Under the Limited Warranty, each tekmar Product is warranted against defects in workmanship and materials if the Product is installed and used in compliance with tekmar's instructions, ordinary wear and tear excepted. The pass-through warranty period is for a period of twenty-four (24) months from the production date if the Product is not installed during that period, or twelve (12) months from the documented date of installation if installed within twenty-four (24) months from the production date.

The liability of tekmar under the Limited Warranty shall be limited to, at tekmar's sole discretion: the cost of parts and labor provided by tekmar to repair defects in materials and / or workmanship of the defective product; or to the exchange of the defective product for a warranty replacement product; or to the granting of credit limited to the original cost of the defective product, and such repair, exchange or credit shall be the sole remedy available from tekmar, and, without limiting the foregoing in any way, tekmar is not responsible, in contract, tort or strict product liability, for any other losses, costs, expenses, inconveniences, or damages, whether direct, indirect, special, secondary, incidental or consequential, arising from ownership or use of the product, or from defects in workmanship or materials, including any liability for fundamental breach of contract.

The pass-through Limited Warranty applies only to those defective Products returned to tekmar during the warranty period. This Limited Warranty does not cover the cost of the parts or labor to remove or transport the defective Product, or to reinstall the repaired or replacement Product, all such costs and expenses being subject to Purchaser's agreement and warranty with its customers.

Any representations or warranties about the Products made by Purchaser to its customers which are different from or in excess of the tekmar Limited Warranty are the Purchaser's sole responsibility and obligation. Purchaser shall indemnify and hold tekmar harmless from and against any and all claims, liabilities and damages of any kind or nature which arise out of or are related to any such representations or warranties by Purchaser to its customers.

The pass-through Limited Warranty does not apply if the returned Product has been damaged by negligence by persons other than tekmar, accident, fire, Act of God, abuse or misuse; or has been damaged by modifications, alterations or attachments made subsequent to purchase which have not been authorized by tekmar; or if the Product was not installed in compliance with tekmar's instructions and / or the local codes and ordinances; or if due to defective installation of the Product; or if the Product was not used in compliance with tekmar's instructions.

THIS WARRANTY IS IN LIEU OF ALL OTHER WARRANTIES, EXPRESS OR IMPLIED, WHICH THE GOVERNING LAW ALLOWS PARTIES TO CONTRACTUALLY EXCLUDE, INCLUDING, WITHOUT LIMITATION, IMPLIED WARRANTIES OF MERCHANTABILITY AND FITNESS FOR A PARTICULAR PURPOSE, DURABILITY OR DESCRIPTION OF THE PRODUCT, ITS NON-INFRINGEMENT OF ANY RELEVANT PATENTS OR TRADEMARKS, AND ITS COMPLIANCE WITH OR NON-VIOLATION OF ANY APPLICABLE ENVIRONMENTAL, HEALTH OR SAFETY LEGISLATION; THE TERM OF ANY OTHER WARRANTY NOT HEREBY CONTRACTUALLY EXCLUDED IS LIMITED SUCH THAT IT SHALL NOT EXTEND BEYOND TWENTY-FOUR (24) MONTHS FROM THE PRODUCTION DATE, TO THE EXTENT THAT SUCH LIMITATION IS ALLOWED BY THE GOVERNING LAW.

**Product Warranty Return Procedure** All Products that are believed to have defects in workmanship or materials must be returned, together with a written description of the defect, to the tekmar Representative assigned to the territory in which such Product is located. If tekmar receives an inquiry from someone other than a tekmar Representative, including an inquiry from Purchaser (if not a tekmar Representative) or Purchaser's customers, regarding a potential warranty claim, tekmar's sole obligation shall be to provide the address and other contact information regarding the appropriate Representative.

WARNING: This product contains chemicals known to the State of California to cause cancer and birth defects or other reproductive harm. For more information: [www.watts.com/prop65](http://www.watts.com/prop65)



Product design, software and literature are Copyright ©2015 by tekmar Control Systems Ltd., A Watts Water Technologies Company. Head Office: 5100 Silver Star Road, Vernon, B.C. Canada V1B 3K4, 250-545-7749, Fax. 250-545-0650 Web Site: [www.tekmarControls.com](http://www.tekmarControls.com)

