

Tankless Water Heater Installation and Operation Manual



Full-length French and Spanish versions available online at rinnai.us

INTERNAL (INDOOR) MODELS:

CU199i (REU-N3237FFC-US)

CU160i (REU-N2530FFC-US)

EXTERNAL (OUTDOOR) MODELS:

CU199e (REU-N3237WC-US)

CU160e (REU-N2530WC-US)

SENSEI™



ANSI Z21.10.3 • CSA 4.3

⚠ WARNING If the information in these instructions is not followed exactly, a fire or explosion may result causing property damage, personal injury, or death.

- Do not store or use gasoline or other flammable vapors and liquids in the vicinity of this or any other appliance.
- WHAT TO DO IF YOU SMELL GAS
 - Do not try to light any appliance.
 - Do not touch any electrical switch; do not use any phone in your building.
 - Immediately call your gas supplier from a neighbor's phone. Follow the gas supplier's instructions.
 - If you cannot reach your gas supplier, call the fire department.
- Installation and service must be performed by a qualified installer, service agency or the gas supplier.

⚠ AVERTISSEMENT Assurez-vous de bien suivre les instructions données dans cette notice pour réduire au minimum le risque d'incendie ou d'explosion ou pour éviter tout dommage matériel, toute blessure ou la mort.

- Ne pas entreposer ni utiliser d'essence ou ni d'autres vapeurs ou liquides inflammables à proximité de cet appareil ou de tout autre appareil.
- QUE FAIRE SI VOUS SENTEZ UNE ODEUR DE GAZ :
 - Ne pas tenter d'allumer d'appareil.
 - Ne touchez à aucun interrupteur ; ne pas vous servir des téléphones se trouvant dans le bâtiment.
 - Appelez immédiatement votre fournisseur de gaz depuis un voisin. Suivez les instructions du fournisseur.
 - Si vous ne pouvez rejoindre le fournisseur, appelez le service des incendies.
- L'installation et l'entretien doivent être assurés par un installateur ou un service d'entretien qualifié ou par le fournisseur de gaz.

Rinnai Customer Care 1-800-621-9419

rinnai.us



Contents

Thank You	3
1. Safety	4
1.1 Safety Symbols.....	4
1.2 Safety Precautions	5
2. About the Water Heater	6
2.1 Items Included	6
2.2 Items Needed for Installation (Not Included).....	6
2.3 Items Not Required But May Be Useful.....	6
2.4 Accessories	7
2.5 Specifications.....	8
2.6 Dimensions	9
3. Install the Water Heater	11
3.1 Installation Guidelines	11
3.2 Choose an Installation Location.....	12
3.3 Mount the Internal (Indoor) Water Heater to the Wall	15
3.4 Mount the External (Outdoor) Water Heater to the Wall.....	16
3.5 Vent the Water Heater	17
3.6 Connect the Water Supply	44
3.7 Install the Isolation Valves.....	45
3.8 Pressure Relieve Valve.....	46
3.9 Condensate.....	48
3.10 Connect the Gas Supply.....	50
3.11 Connect the Power Supply	53
3.12 Parameter Settings	54
3.13 External Pump with Circ-Logic.....	55
3.14 Service Indicator (Service Soon, 55)	56
3.15 Post-Water Heater Installation Checklist	57
4. Operate the Water Heater	58
4.1 Safety Precautions	58
4.2 Controller.....	59
4.3 Setting the Temperature	60
4.4 Performance Data.....	61
4.5 Diagnostic Codes	62
5. Maintain the Water Heater	63
5.1 Maintenance.....	63
5.2 Cleaning and Inspecting the Air Filter (Indoor Units Only).....	65
5.3 Flushing the Heater Exchanger	66
5.4 Draining the Water Heater	67
6. Appendices	69
6.1 Wiring Diagram.....	69
6.2 Ladder Diagram	70
6.3 Pressure Drop and Water Flow Curves.....	71
6.4 Guidelines for Additional Temperature Controllers.....	72
6.5 Massachusetts State Gas Regulations	73
6.6 Warranty.....	74

Thank You

Thank you for purchasing a Rinnai Tankless Water Heater. Before installing and operating this water heater, be sure to read these instructions completely and carefully to familiarize yourself with the water heater's features and functionality.

If You Need Service

Contact your local dealer/distributor or call Rinnai Customer Care at 1-800-621-9419 Monday to Friday between 8 AM to 8 PM ET. Please have your full serial number or model number available for product- or service-related issues.

To The Installer

- A trained and qualified professional must install the water heater, inspect it, and leak test it before use. The warranty will be voided due to any improper installation.
- The trained and qualified professional should have skills such as:
 - Gas sizing
 - Connecting gas lines, water lines, valves, and electricity
 - Knowledge of applicable national, state, and local codes
 - Installing venting through a wall or roof
 - Training in installation of tankless water heaters. Training on Rinnai Tankless Water Heaters is accessible at www.trainingevents.rinnai.us
- Read all instructions in this manual before installing the water heater. The water heater must be installed according to the exact instructions in this manual.
- Proper installation is the responsibility of the installer.
- When installation is complete, leave this manual with the water heater (for internal/indoor units) or give the manual directly to the consumer.

To The Consumer

- You must read the entire manual to properly operate the water heater and to have regular maintenance performed.
- Keep this manual for future reference.
- As when using any appliance generating heat, there are certain safety precautions you should follow. See section “1.2 Safety Precautions” for detailed safety precautions.
- Be sure your water heater is installed by a licensed installer.
- If installing in the state of Massachusetts, you must read section “6.5 Massachusetts State Gas Regulations” in this manual.

1. Safety

WARNING

- If the information in these instructions is not followed exactly, a fire or explosion may result causing property damage, personal injury, or death.
- Do not store or use gasoline or other flammable vapors and liquids in the vicinity of this or any other appliance.
- WHAT TO DO IF YOU SMELL GAS:
 - Do not try to light any appliance.
 - Do not touch any electrical switch; do not use any phone in your building.
 - Immediately call your gas supplier from a neighbor's phone. Follow the gas supplier's instructions.
 - If you cannot reach your gas supplier, call the fire department.
- Installation and service must be performed by a qualified installer, service agency or the gas supplier.
- The warning signs in this manual are here to prevent injury to you and others. Please follow them explicitly.

AVERTISSEMENT

- Assurez-vous de bien suivre les instructions données dans cette notice pour réduire au minimum le risque d'incendie ou d'explosion ou pour éviter tout dommage matériel, toute blessure ou la mort.
- Ne pas entreposer ni utiliser d'essence ou ni d'autres vapeurs ou liquides inflammables à proximité de cet appareil ou de tout autre appareil.
- QUE FAIRE SI VOUS SENTEZ UNE ODEUR DE GAZ :
 - Ne pas tenter d'allumer d'appareil.
 - Ne touchez à aucun interrupteur ; ne pas vous servir des téléphones se trouvant dans le bâtiment.
 - Appelez immédiatement votre fournisseur de gaz depuis un voisin. Suivez les instructions du fournisseur.
 - Si vous ne pouvez rejoindre le fournisseur, appelez le service des incendies.
- L'installation et l'entretien doivent être assurés par un installateur ou un service d'entretien qualifié ou par le fournisseur de gaz.
- Les panneaux d'avertissement de ce manuel sont ici pour éviter de vous blesser et d'autres personnes. Suivez-les explicitement.

1.1 Safety Symbols



Safety alert symbol. Alerts you to potential hazards that can kill or hurt you and others.



Indicates an imminently hazardous situation which, if not avoided, will result in personal injury or death.



Indicates a potentially hazardous situation which, if not avoided, could result in personal injury or death.



Indicates a potentially hazardous situation which, if not avoided, could result in minor or moderate injury. It may also be used to alert against unsafe practices.

1.2 Safety Precautions

The following precautions apply to the installer and consumer. Read and follow all instructions in this section.



WARNING

DO NOT adjust the internal gas valve. The design is such that adjustment is not required. Warranty will be voided if the internal gas valve is adjusted.

- Before operating, smell all around the appliance area for gas. Be sure to smell next to the floor because some gas is heavier than air and will settle on the floor.
- Keep the area around the appliance clear and free from combustible materials, gasoline, and other flammable vapors and liquids.
- Combustible construction refers to adjacent walls and ceiling and should not be confused with combustible or flammable products and materials. Combustible and/or flammable products and materials should never be stored in the vicinity of this or any gas appliance.
- Always check the water temperature before entering a shower or bath.
- To protect yourself from harm, before performing maintenance:
 - Turn off the electrical power supply by unplugging the power cord or by turning off the electricity at the circuit breaker. (The temperature controller does not control the electrical power.)
 - Turn off the gas at the manual gas control valve, usually located immediately below the water heater.
 - Turn off the incoming water supply. This can be done at the isolation valve immediately below the water heater or by turning off the water supply to the building.
 - Use only your hand to turn the manual gas control valve. Never use tools. If the manual gas control valve will not turn by hand, do not try to repair it; call a trained and qualified professional. Force or attempted repair may result in a fire or explosion.
- Do not use this appliance if any part has been under water. Immediately call a licensed professional to inspect the appliance and to replace any part of the control system and any manual gas control valve which has been under water.
(N'utilisez pas cet appareil s'il a été plonge dans l'eau, même partiellement. Faites inspecter l'appareil par un licence professionnelle et remplacez toute partie du système de contrôle et toute commande qui ont été plongés dans l'eau.)
- Do not use substitute materials. Use only parts certified for the appliance.
- Should overheating occur or the gas supply fail to shut off, turn off the manual gas control valve to the appliance.
(En cas de surchauffe ou si l'alimentation en gaz ne s'arrête pas, fermez manuellement le robinet d'arrêt de l'admission de gaz.)
- Only trained and qualified professionals are permitted to adjust parameter settings.
- Do not use an extension cord or adapter plug with this appliance.
- Any alteration to the appliance or its controls can be dangerous and will void the warranty.
- Proper venting is required for the safe operation of this appliance.
- Flammable liquids such as cleaning solvents, aerosols, paint thinners, adhesives, gasoline and propane must be handled and stored with extreme care. These flammable liquids emit flammable vapors and when exposed to an ignition source can result in a fire hazard or explosion. Flammable liquids should not be used or stored in the vicinity of this or any other gas appliance.
- DO NOT operate the water heater without the front panel installed. The front panel should only be removed for service/maintenance or replacing internal components.
- BURN HAZARD. Hot exhaust and vent may cause serious burns. Keep away from the water heater. Keep small children and animals away from the water heater.
- Hot water outlet pipes leaving the water heater can be hot to touch.
- Do not store or use gasoline or other flammable vapors and liquids in the vicinity of this or any other appliance.
(Ne pas entreposer ni utiliser d'essence ou ni d'autres vapeurs ou liquides inflammables à proximité de cet appareil ou de tout autre appareil.)
- Install the vent system per local and national codes.
- Do not install this water heater above 10,200 ft (3,109 m).
- Do not obstruct combustion air to the water heater.
- Failure to properly vent this appliance can result in death, personal injury and/or property damage.
- Rinnai recommends that every home have a carbon monoxide (CO) alarm in the hallway near bedrooms in each sleeping area. Check batteries monthly and replace them annually.
- California law requires the following Proposition 65 warning to be provided:



WARNING

This product can expose you to chemicals including lead, lead compounds and carbon disulfide which are known to the State of California to cause cancer, birth defects or other reproductive harm. For more information, visit www.P65Warnings.ca.gov.

2. About the Water Heater

2.1 Items Included

Unpack the Rinnai Tankless Water Heater package and verify the following contents are included. If any items are missing, contact your local dealer/distributor or call Rinnai Customer Care at 1-800-621-9419.

- Rinnai Tankless Water Heater
- Wall Mounting Bracket (for internal/indoor water heaters only)
- Pressure Relief Valve and Adapter
- Isolation Valve Kit (for quick isolation of the water heater for service and/or maintenance)
- Literature Bag
 - Tankless Water Heater Installation and Operation Manual (this manual)
 - Wall Mounting Bracket Template (for internal/indoor water heaters only)
 - Model/Serial Number Labels (with printed QR code)
- External Pump Cable (for external recirculation pump control)
- Controller Cable (for additional controller connection)
- Vent screens (x2) and vent screen screws (x2) (for internal/indoor water heaters only). The vent screen prevents debris and other objects from entering the terminal. One vent screen is for the intake; the other is for the exhaust
- Self-Tapping Screws (x2) (for internal/indoor water heaters only)

2.2 Items Needed for Installation (Not Included)









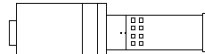
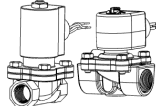

- Pipe wrenches (x2)
- Phillips Head screwdriver
- Wire cutters
- Gloves
- Safety glasses
- Level
- Soap or gas leak detector solution
- Approved venting
- Teflon tape (recommended) or pipe compound
- Pipe insulation

2.3 Items Not Required But May Be Useful

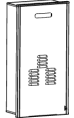
- Hammer drill with concrete bits
- Saw
- Threading machine with heads and oiler
- Core drill with diamond head
- Torch set
- Copper tubing cutter
- Steel pipe cutter
- Heat tape
- Electrical wire
- Concrete wall anchors
- Optional pipe cover
- PVC glue/cement and primer
- 2 conductor 22 AWG wire for controller
- Single gang electrical box
- Wire nuts
- Unions and drain valves

2.4 Accessories

Numerous optional accessories are available for purchase for your Rinnai Tankless Water Heater. Listed below are some commonly purchased accessories. For a complete list of accessories, visit www.rinnai.us. For questions, or to purchase an accessory, contact your local Rinnai dealer/distributor or Rinnai Customer Care at 1-800-621-9419.

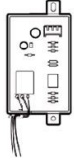
Product	Product Description	Image
Room Air Screen	Recommended air filter/screen for use in room air applications only.	
Condensate Neutralizer	Neutralizes the condensate generated by the water heater.	
ScaleCutter	Filters and reduces the amount of scale entering the water heater allowing for greater water heater longevity.	
ScaleCutter Refill Cartridge	Refill cartridge for the ScaleCutter filter assembly.	
Drain Down Kit	Provides freeze protection by immediately draining the water heater upon loss of power.	
Additional Controller	Additional controllers are available for user convenience.	
Recess Box	Allows an external (outdoor) water heater to be recessed into a wall.	
Pipe Cover	Encloses the piping below the water heater for aesthetic purposes.	
Control-R™ Wi-Fi Module (And Accessories)	Controls On-Demand recirculation, remotely adjust temperatures, and communicates with the service provider portal. The Control-R™ Wi-Fi Module and MC-195T-US controller are not compatible accessories and must not be installed together.	
Recirculation Pump	A pump system can be incorporated with Rinnai Circ-Logic recirculation technology in a dedicated recirculation system.	
EZConnect™ Cable	Electronically connects two water heaters and allows them to function as one hot water source.	
Cascade Cable	Electronically connects up to 24 water heaters and enables them to function as one hot water source. Note: One cable is needed for each water heater.	
DPS/MIS Switch	<ul style="list-style-type: none"> The DPS function provides domestic hot water priority for combination tankless water heater/air handler applications. The MIS function provides tankless water heater monitoring via systems such as BMS (Building Management System). 	

2.5 Specifications

		Internal (Indoor) Units		External (Outdoor) Units	
		CU199i	CU160i	CU199e	CU160e
Minimum Gas Consumption Btu/h		15,000			
Maximum Gas Consumption Btu/h		199,000	160,000	199,000	160,000
Flow Rate ¹ (Min - Max)		0.26 - 9.8 GPM (1.0 - 37 L/min)	0.26 - 8.0 GPM (1.0 - 30 L/min)	0.26 - 9.8 GPM (1.0 - 37 L/min)	0.26 - 8.0 GPM (1.0 - 30 L/min)
Max Flow Rate with Parameter Adjustment		11 GPM (42 L/min)	9 GPM (34 L/min)	11 GPM (42 L/min)	9 GPM (34 L/min)
Weight		64 lb (29 kg)	62 lb (28 kg)	64 lb (29 kg)	62 lb (28 kg)
Sound level		49 dB	48 dB	53 dB	52 dB
Electrical Data	Normal	84 W	52 W	81 W	49 W
	Standby	1.3 W			
	Freeze Protection	148 W		152 W	
	Max Current	4 Amps			
	Fuse	10 Amps			
Temperature Setting		<ul style="list-style-type: none"> • Minimum: 98° F (37° C) • Maximum: Default: 140° F (60° C) With Parameter Adjustment: 185° F (85° C) 			
By-Pass Flow Control		Electronic			
Gas Supply Pressure ²	Natural	3.5 in. w.c. - 10.5 in. w.c.			
	Propane	8.0 in. w.c. - 13.5 in. w.c.			
Type of Appliance		Super-High-Efficiency (Condensing), Tankless, Temperature Controlled Continuous Flow Gas Hot Water System			
Ignition System		Direct Electronic Ignition			
Electric Connections		<ul style="list-style-type: none"> • Appliance: AC 120 Volts, 60Hz. • Temperature Controller: DC 12 Volts (Digital) 			
Water Supply Pressure		<ul style="list-style-type: none"> • Minimum: 50 PSI (Recommended 60-80 PSI for maximum performance) • Maximum: 150 PSI 			
Remote Control Cable		Non-Polarized Two Core Cable (Minimum 22 AWG)			
ENERGY STAR® Qualified		Yes			
Complies with South Coast Air Quality Management District 14 ng/J or 20 ppm NOx emission levels		Yes			

¹ Minimum flow may vary slightly depending on the temperature setting and the inlet water temperature. Minimum activation flow is 0.4 GPM (1.5 L/min).

² The maximum gas supply pressure must not exceed the value specified by the manufacturer.

Rinnai products are continually being updated and improved; therefore, specifications are subject to change without prior notice.

2.6 Dimensions

Measurements: in. (mm)

Internal (Indoor) Models (CU199i and CU160i)

Vent Connection:

2 in. (51 mm) nominal
PVC/Polypropylene or
3 in./5 in. Concentric.

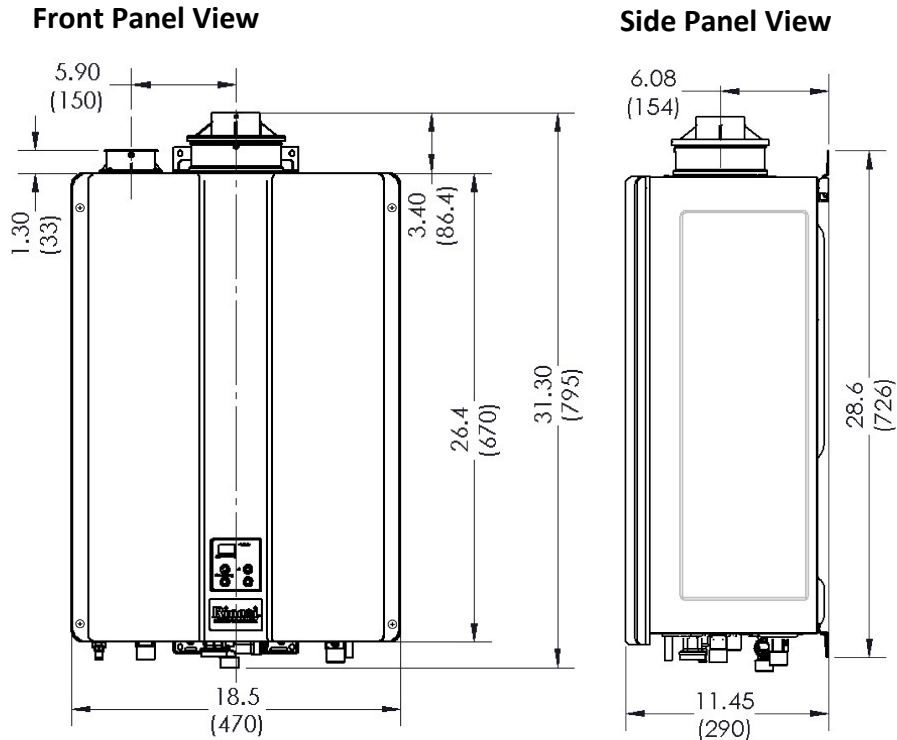

External (Outdoor) Models (CU199e and CU160e)

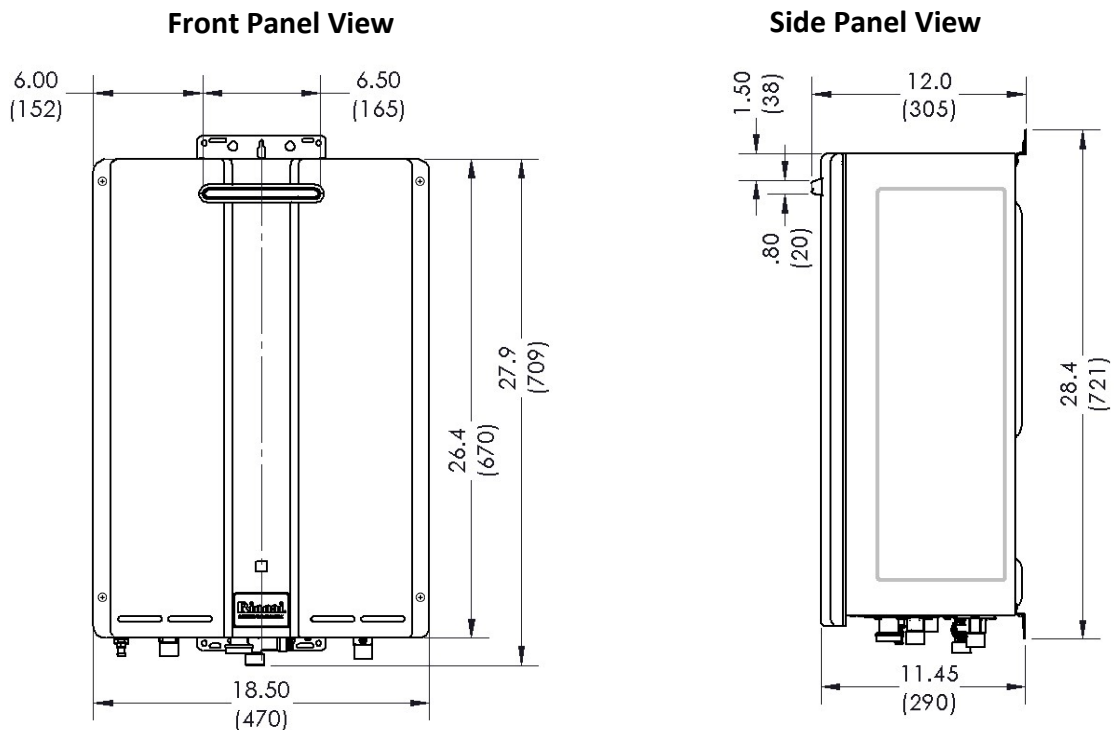

Connections (for Internal and External Water Heaters)

Measurements: in. (mm)

Bottom View of Water Heater

GAS
3/4 INCH NPT

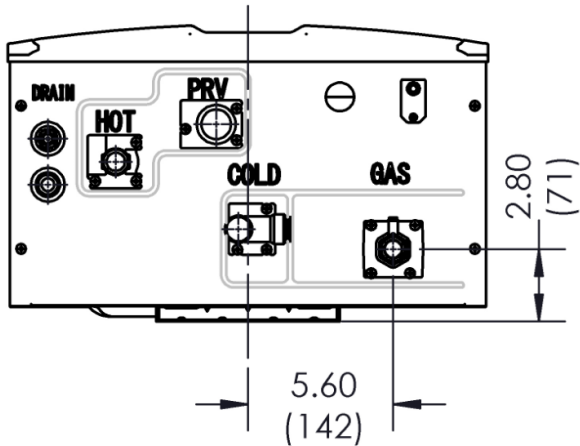

CONDENSATE DRAIN
1/2 INCH NPT

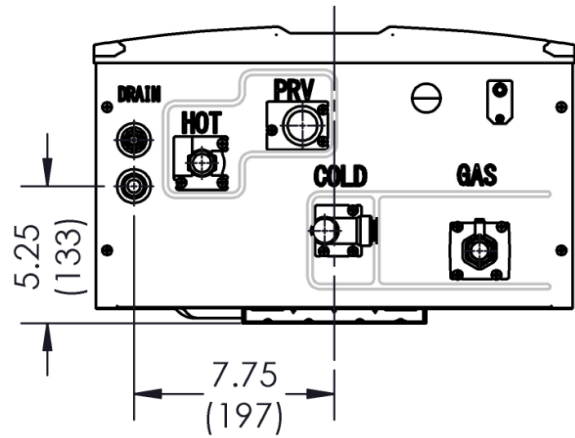

COLD INLET
3/4 INCH NPT

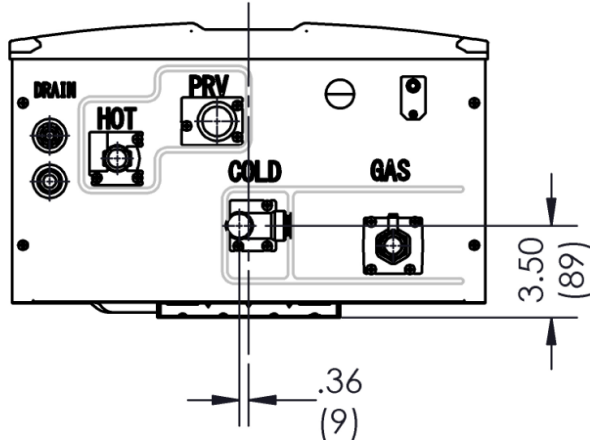

HOT OUTLET
3/4 INCH NPT

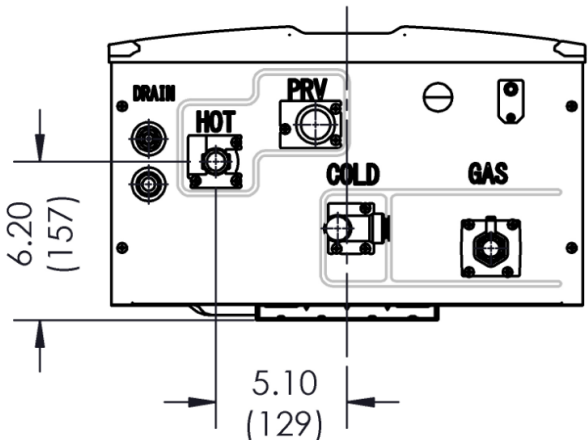

Pressure Relief Valve (PRV)

M33 THREAD

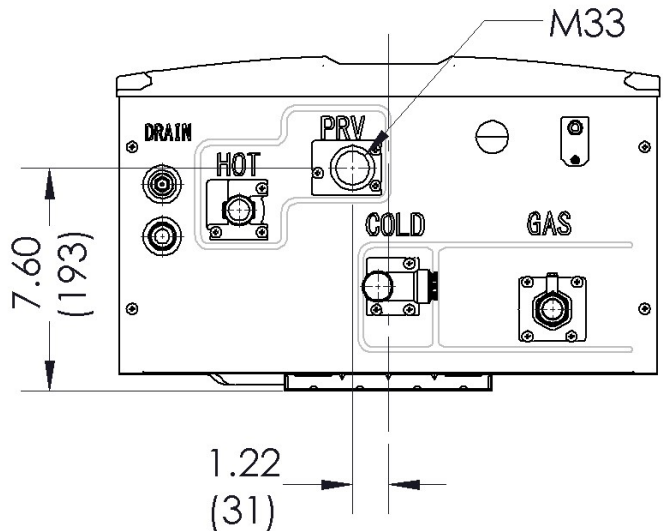
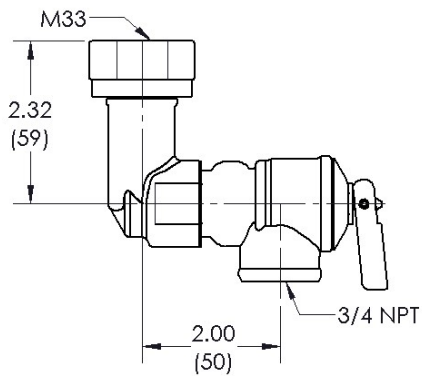

3. Install the Water Heater

THIS SECTION IS INTENDED FOR THE INSTALLER

Installer qualifications: A trained and qualified professional must install the appliance, inspect it, and leak test the water heater before use. The warranty will be voided due to any improper installation. The trained and qualified professional should have skills such as: Gas sizing; Connecting gas lines, water lines, valves, and electricity; Knowledge of applicable national, state, and local codes; Installing venting through a wall or roof; and training in installation of tankless water heaters. Training for Rinnai Tankless Water Heaters is accessible online at www.trainingevents.rinnai.us.

3.1 Installation Guidelines

When installing the water heater, follow these guidelines:

- This water heater is suitable for combination water heating and space heating and not suitable for space heating applications only.
- The installation must conform with local codes or, in the absence of local codes, with the *National Fuel Gas Code, ANSI Z223.1/NFPA 54*, or the *Natural Gas and Propane Installation Code, CSA B149.1*.
- The appliance, when installed, must be electrically grounded in accordance with local codes or, in the absence of local codes, with the *National Electrical Code, ANSI/NFPA 70*, or the *Canadian Electrical Code, CSA C22.1*.
- The appliance and its main gas valve must be disconnected from the gas supply piping system during any pressure testing of that system at test pressures in excess of 1/2 psi (3.5 kPa) (13.84 in W.C.). For system testing at pressures less than or equal to 1/2 psi (3.5 kPa) (13.84 in W.C.) the appliance must be isolated from the gas supply piping by closing its individual manual shutoff valve.
- You must follow the installation instructions and those in section “3.5 Vent the Water Heater” for adequate combustion air and exhaust.
- If a water heater is installed in a closed water supply system, such as one having a backflow preventer in the cold water supply line, means shall be provided to control thermal expansion. Contact the water supplier or local plumbing inspector on how to control thermal expansion.
- Should overheating occur or the gas supply fail to shut off, turn off the manual gas control valve to the appliance.
(En cas de surchauffe ou si l'alimentation en gaz ne s'arrête pas, fermez manuellement le robinet d'arrêt de l'admission de gaz.)
- Combustion air must be free of chemicals, such as chlorine or bleach, that produce fumes. These fumes can damage components and reduce the life of your appliance.

DO NOT

- ❌ DO NOT install the following internal (indoor) water heaters outdoor: CU160i and CU199i
- ❌ DO NOT install the following external (outdoor) water heaters indoor: CU160e and CU199e
- ❌ DO NOT install the water heater in an area where water leakage of the unit or connections will result in damage to the area adjacent to the appliance or to lower floors of the structure. When such locations cannot be avoided, it is recommended that a suitable drain pan, adequately drained, be installed under the water heater. The pan must not restrict combustion air flow.
- ❌ DO NOT install the water heater in an area with negative air pressure.
- ❌ DO NOT obstruct the flow of combustion and ventilation air.
- ❌ DO NOT use this appliance in an application such as a pool or spa heater that uses chemically treated water. This appliance is suitable for filling large or whirlpool spa tubs with potable water.
- ❌ DO NOT use substitute parts that are not authorized for this appliance.

3.2 Choose an Installation Location

When selecting an installation location, you must ensure that clearances will be met and that the vent length will be within required limits. Consider the installation environment, water quality, and need for freeze protection. Requirements for the gas line, water lines, electrical connection, and condensate disposal can be found in their respective installation sections in this manual.

Water Quality Guidelines

This section provides information on the importance of water quality to the Rinnai Tankless Water Heater. The information is intended to serve as general guidelines only and is not a complete list of water quality guidelines.

Consideration of care for your water heater should include evaluation of water quality. The water must be potable, free of corrosive chemicals, sand, dirt, or other contaminants. It is up to the installer to ensure the water does not contain corrosive chemicals or elements that can affect or damage the Rinnai Tankless Water Heater. Water that contains chemicals exceeding the levels below can damage the Rinnai Tankless Water Heater. Replacement of components due to water quality damage is not covered by the warranty.

Contaminant	Maximum Level
Total Hardness	Up to 200 mg/L
Aluminum *	Up to 0.2 mg/L
Chlorides *	Up to 250 mg/L
Copper *	Up to 1.0 mg/L
Dissolved Carbon Dioxide (CO ₂)	Up to 15.0 mg/L
Iron *	Up to 0.3 mg/L
Manganese *	Up to 0.05 mg/L
pH *	6.5 to 8.5
TDS (Total Dissolved Solids) *	Up to 500 mg/L
Zinc *	Up to 5 mg/L

* Source: Part 143 National Secondary Drinking Water Regulations

If you install this water heater in an area that is known to have hard water or that causes scale build-up, the water must be treated and may require a more frequent flushing schedule.

This water heater includes a service indicator (Service Soon, 55). When selected in the parameter settings, an 55 code will display on the controller indicating that it is time to flush and service the water heater. Scale build-up is caused by hard water and can be accelerated if the water heater is set at a high temperature.

Rinnai offers Southeastern Filtration's "ScaleCutter Water Conditioning System" that offers superior lime scale prevention and corrosion control by feeding a blend of control compounds into the cold water supply.

Environment

Air surrounding the water heater, venting, and vent termination(s) is used for combustion and must be free of any compounds that cause corrosion of internal components. These include corrosive compounds that are found in aerosol sprays, detergents, bleaches, cleaning solvents, oil based paints/varnishes, and refrigerants. The air in beauty shops, dry cleaning stores, photo processing labs, and storage areas for pool supplies often contains these compounds. Therefore, it is recommended that external (outdoor) models be used for these locations where possible. In applications utilizing room air where there are high levels of particulates, Rinnai offers a room air screen. The water heater, venting, and vent termination(s) should not be installed in any areas where the air may contain these corrosive compounds.

Internal (Indoor) Water Heaters

- Install the water heater as far away as possible from any air inlet vents. Corrosive fumes, sometimes found in hair/nail salons, spas, or other industries exposed to toxic fumes, may be released through these vents when not in operation. Chemicals that are corrosive in nature should not be stored or used near the water heater or vent termination. This requirement applies to internal (indoor) and external (outdoor) water heaters.
- In coastal regions, the water heater should be installed so that it is sheltered/protected from exposure to sea breeze. Exposure to salty spray or breeze can cause corrosion of the water heater.



DO NOT install the water heater in areas where combustion air might be contaminated with chemicals.



DO NOT use room air in applications where the indoor air is corrosive. Install the water heater as direct vent in a sealed closet so that it is protected from the potential of contaminated indoor air.

External Water Heaters and Vent Terminations

- Install the water heater as far away as possible from exhaust vent hoods and dryer vents.
- In coastal regions, the water heater should be installed so that it is sheltered/protected from exposure to sea breeze. Exposure to salty spray or breeze can cause corrosion of the water heater.
- Damage and repair due to corrosive compounds in the air is not covered by warranty.
- Install the water heater as far away as possible from any air inlet vents. Corrosive fumes, sometimes found in hair/nail salons, spas, or other industries exposed to toxic fumes, may be released through these vents when not in operation. Chemicals that are corrosive in nature should not be stored or used near the water heater or vent termination. This requirement applies to internal (indoor) and external (outdoor) water heaters.

Freeze Protection

Make sure that in case of freezing weather the water heater and its water lines are protected to prevent freezing. Damage due to freezing is not covered by the warranty.

When connected to a 120-volt power supply, the water heater will not freeze when the outside air temperature is as cold as -22°F (-30°C) for internal (indoor) models or -4°F (-20°C) for external (outdoor) models, when protected from direct wind exposure. Because of the “wind-chill” effect, any wind or circulation of the air on the water heater will reduce its ability to protect itself from freezing.

In the event of a power failure and/or gas interruption at temperatures below freezing, the water heater should manually be drained of all water to prevent freezing damage. In addition, drain the condensate trap, drain line and pressure relief valve.

Loss of freeze protection may result in water damage from a burst heat exchanger or water lines.

The water heater may be drained manually. However, it is highly recommended to install the optional Drain Down Kit accessory that will enable the water heater to immediately drain upon loss of power (the condensate trap and pressure relief valve are not affected by the Drain Down Kit and must be manually drained).

The freeze protection features will not prevent the external piping and valves from freezing. It is recommended that hot and cold water pipes be insulated. Pipe cover enclosures may be packed with insulation for added freeze protection.

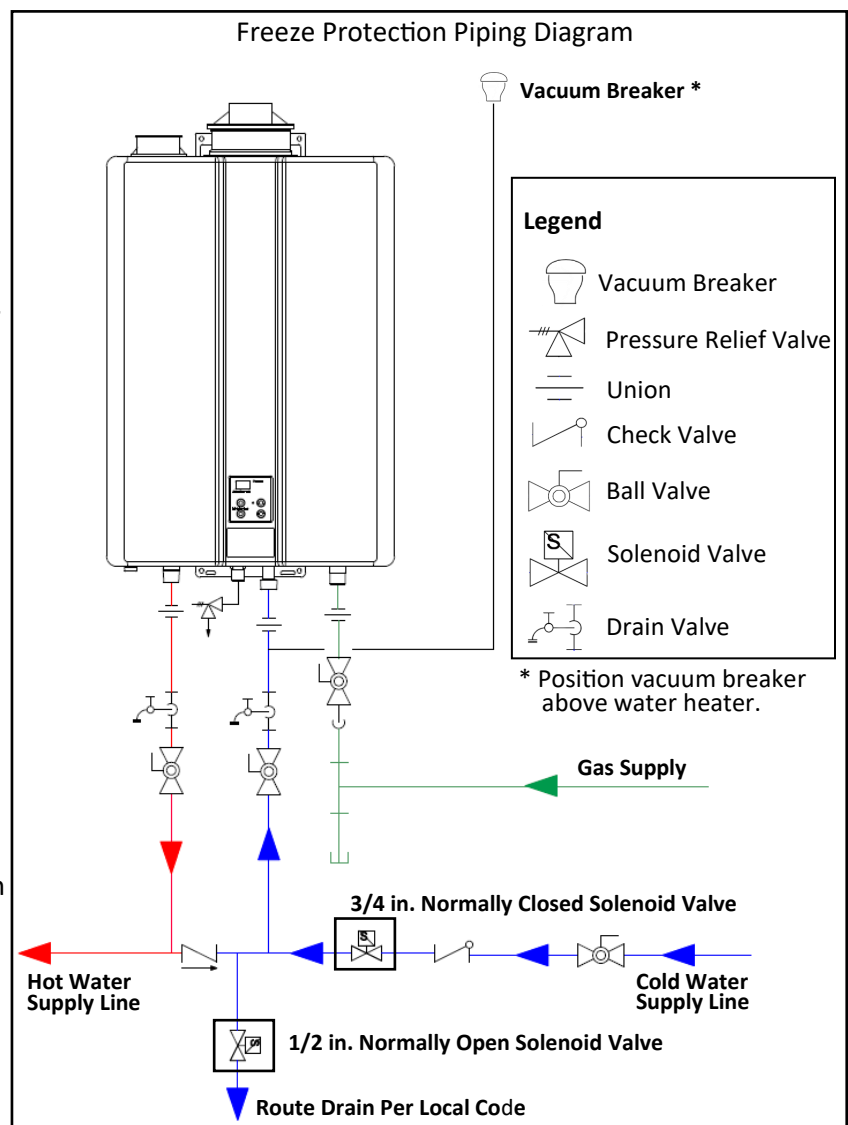

CLEARANCES

Top	2 in. (51 mm) <i>0 in from vent components</i>
Bottom/Ground	12 in. (305 mm)
Front	0 in. <i>Clearance for servicing is 24 in. (610 mm) in front of water heater</i>
Back	0 in.
Sides (Left and Right)	2 in. (51 mm) <i>Add 0.25 in. (6.35 mm) for recess box</i>
Vent <i>(Internal/Indoor Models)</i>	0 in.
Front Exhaust <i>(External/Outdoor Models)</i>	24 in. (610 mm)

INTERNAL (INDOOR) MODELS

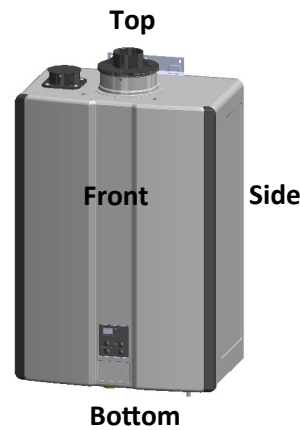

EXTERNAL (OUTDOOR) MODELS

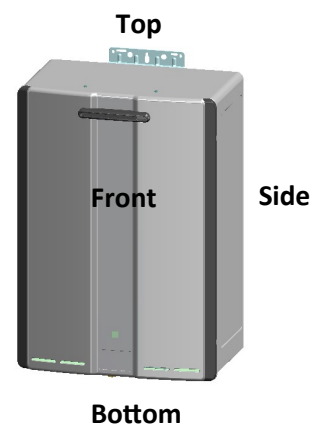

INSTALLATION LOCATION CHECKLIST

Use this checklist to ensure you have selected the correct location for the water heater.

<input type="checkbox"/>	The water heater is not exposed to corrosive compounds in the air.
<input type="checkbox"/>	The water heater location complies with the required clearances.
<input type="checkbox"/>	The planned combustion air and exhaust termination locations meet the required clearances.
<input type="checkbox"/>	The water supply does not contain chemicals or exceed total hardness that will damage the heat exchanger.
<input type="checkbox"/>	A standard 3 prong 120 VAC, 60 Hz properly grounded wall outlet (for internal/indoor models) or other 120 VAC, 60 Hz source is available.
<input type="checkbox"/>	The installation must conform with local codes or, in the absence of local codes, with the <i>National Fuel Gas Code, ANSI Z223.1/NFPA 54</i> , or the <i>Natural Gas and Propane Installation Code, CSA B149.1</i> .

3.3 Mount the Internal (Indoor) Water Heater to the Wall

You Will Need:

- Rinnai Tankless Water Heater (Internal/Indoor Model)
- Wall Mounting Bracket

Supplied by Installer:

- Level
 - 4 screws for mounting bracket installation
 - Screws for top and bottom bracket installation
- Use appropriate screws for type of wall construction.*

1

Hold the wall mounting bracket up against the wall and use a level to make sure the bracket is even. Proper operation requires the water heater to be level.

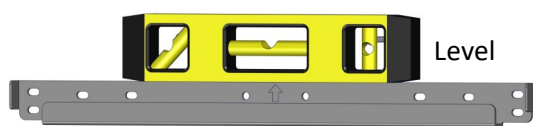

Wall Mounting Bracket

2

Use 4 screws to secure the wall mounting bracket to the wall (2 screws on far left side and 2 screws on far right side).

Use the appropriate screws for the wall construction to secure the mounting bracket to the wall between two studs.

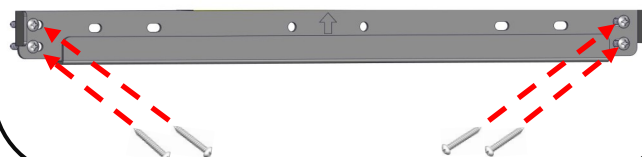

3

Insert the water heater top bracket into the wall mounting bracket.

Make sure the wall mounting bracket is sturdy and can hold the weight of the water heater before you fully let go.

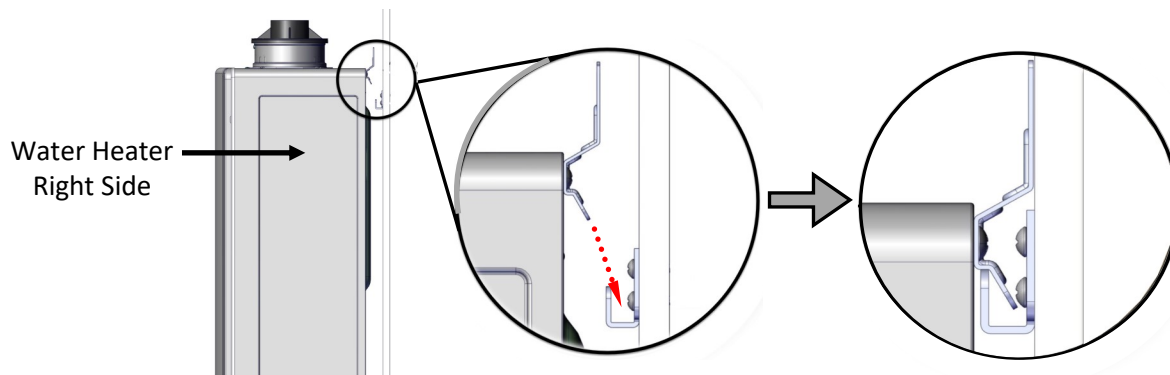

4

Securely screw the top and bottom brackets into the wall, making sure the screws are flush with the wall.

- Use any of the holes in the top and bottom brackets.
- Make sure the securing method is sufficient to support the weight of the water heater. Refer to the water heater weight in section "2.5 Specifications."

IMPORTANT: The water heater must be installed in an upright position. Do not install the water heater upside down or on its side.

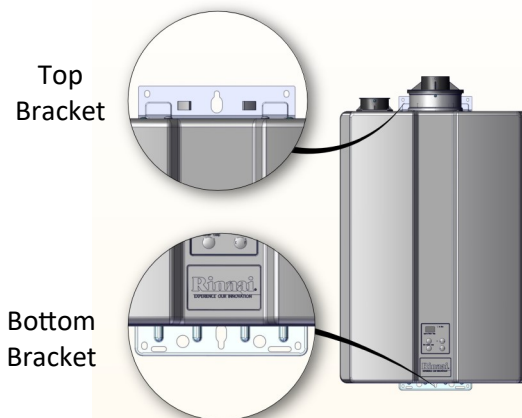

3.4 Mount the External (Outdoor) Water Heater to the Wall

You Will Need:

- Rinnai Tankless Water Heater
(External/Outdoor Model)

Supplied by Installer:

- Level
- Screws for top and bottom bracket installation
Use appropriate screws for type of wall construction.

Instructions: Securely screw the top and bottom brackets into the wall, making sure the screws are flush with the wall.

- Use any of the holes in the top and bottom brackets.
- Use a level (placed horizontally or vertically) to make sure the water heater is straight. Proper operation requires the water heater to be level.
- Make sure the securing method is sufficient to support the weight of the water heater. Refer to the water heater weight in section “2.5 Specifications.”

IMPORTANT: The water heater must be installed in an upright position. Do not install the water heater upside down or on its side.

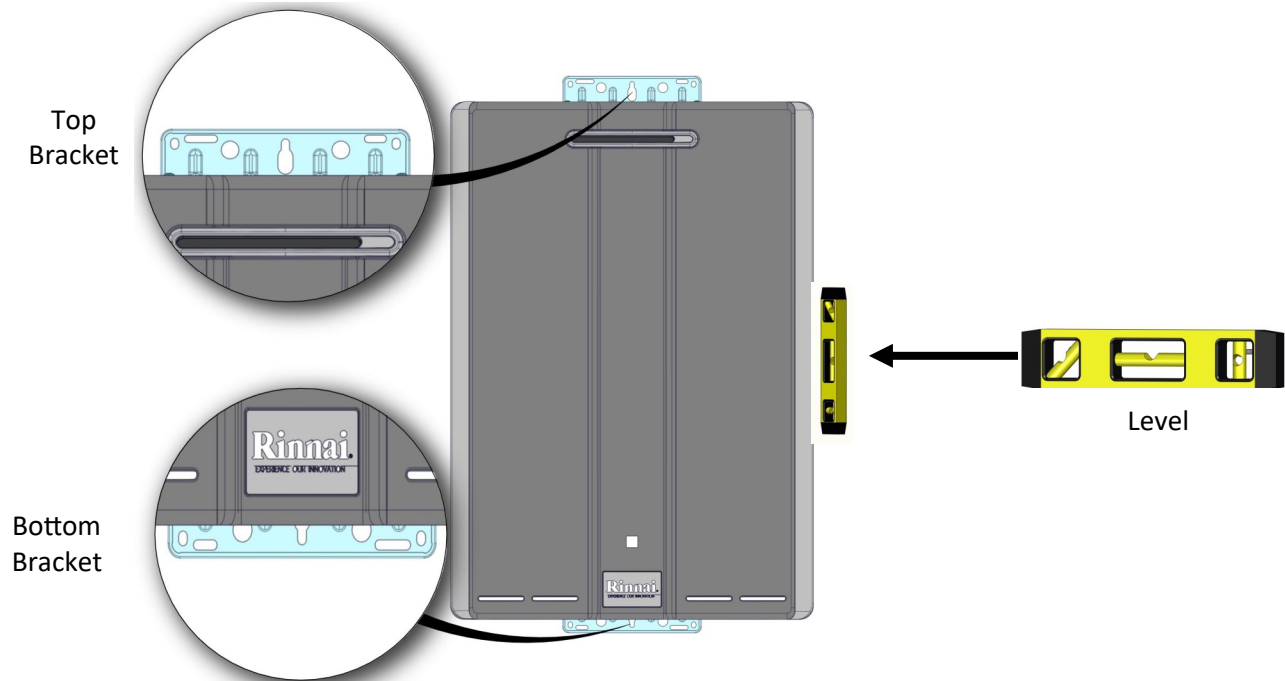







3.5 Vent the Water Heater

Guidelines

- Internal water heaters can be installed as direct vent or non-direct vent applications.
- When installed as Direct Vent, refer to the “Direct Vent Approved Vent Manufacturers and Products” section (within the “1. Direct Vent” section) for a complete list of approved vent manufacturers and products.
- When installed as Non-Direct Vent (Room Air), the vent must be Category IV and of a type listed by a national recognized testing agency.
- Exhaust must be directly vented to the outside. Combustion air can be provided from outside (Direct Vent) or from room air (Non-Direct Vent).
- If using room air (non-direct vent) for combustion, ensure the required volume of indoor air is available according to the National Fuel Gas Code, ANSI Z223.1/NFPA 54.
- Avoid dips or sags in horizontal vent runs by installing supports per the vent manufacturer’s instructions.
- Support horizontal vent runs every 4 ft (1.2 m) and all vertical vent runs every 6 ft (1.83 m) or as per vent manufacturer’s instructions or local code requirements.
- Venting should be as direct as possible with a minimum number of pipe fittings.
- For manufactured vent systems, vent connections must be firmly pressed together so that the connections form an air tight seal. Follow the venting manufacturer’s instructions.
- Refer to the PVC/CPVC manufacturer for appropriate fittings, solvents or joining methods.
- The vent piece connected to the water heater must be secured with 1 self-tapping screw.
- Refer to the instructions of the vent system manufacturer for component assembly instructions.
- If the vent system is to be enclosed, it is suggested that the design of the enclosure shall permit inspection of the vent system. The design of such enclosure shall be deemed acceptable by the installer or the local inspector.
- Any issues resulting from improper vent installation will not be covered by warranty.

WARNING

-  DO NOT use cellular core PVC/CPVC.
-  DO NOT use Radel, ABS, or galvanized material to vent this appliance.
-  DO NOT cover non-metallic vent pipe and fittings with thermal insulation.
-  DO NOT combine vent components from different manufacturers.
-  DO NOT reduce the vent diameter. Vent diameter cannot be less than 2 in. (51 mm).
-  DO NOT connect the venting system with an existing vent or chimney.
-  DO NOT common vent with the vent pipe of any other manufacturer’s water heater or appliance. Rinnai water heaters can only be common vented with Schedule 40 PVC/CPVC or with a Rinnai certified common vent system.

Venting Installation Sequence

1. Install the water heater.
2. Determine the termination method—horizontal or vertical, concentric, or twin pipes, etc.
3. Determine proper location for wall or roof penetration for each termination.
4. Install termination assembly as described in this manual or in the vent manufacturer's installation instructions.
5. Install air and vent piping from water heater to termination.
6. Slope horizontal exhaust run towards the water heater 1/4 in per foot. DO NOT slope combustion air pipe towards water heater.
7. Install vent supports and brackets allowing for movement from expansion, or as per vent manufacturer's instructions or local code requirements.
8. Install vent screen (supplied with water heater) on PVC combustion air and exhaust termination elbows as illustrated below.

- Press vent screen inside of termination piece/elbow.
- Secure vent screen to the elbow with screw provided.

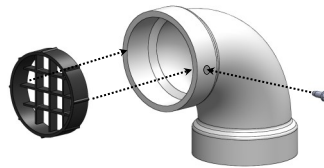

Termination Considerations

Check to determine whether local codes supersede the following clearances:

- Avoid termination locations near a dryer vent.
- Avoid termination locations near commercial cooking exhaust.
- Avoid termination locations near any air inlets.
- You must install a vent termination at least 12 in above the ground or anticipated snow level.

The vent for this appliance shall not terminate:

- Over public walkways.
- Near soffit vents or crawl space vents or other area where condensate or vapor could create a nuisance or hazard or cause property damage.
- Where condensate or vapor could cause damage or could be detrimental to the operation of regulators pressure relief valves, or other equipment.

Listed below are important considerations for locating vent termination under a soffit (ventilated or unventilated or eave vent; or to a deck or porch):

- Do not install vent termination under a soffit vent such that exhaust can enter the soffit vent.
- Install vent termination such that exhaust and rising moisture will not collect under eaves. Discoloration to the exterior of the building could occur if installed too close.
- Do not install the vent termination too close under the soffit where it could present recirculation of exhaust gases back into the combustion air part of the termination.

Select a Vent Type

Three types of venting options are available:

1 Direct Vent *(Concentric Pipe and Twin Pipe)*

Concentric Pipe

Combustion air and exhaust vent directly through a single concentric connection. Hot exhaust exits through the interior tube, while combustion air enters through the outer layer.

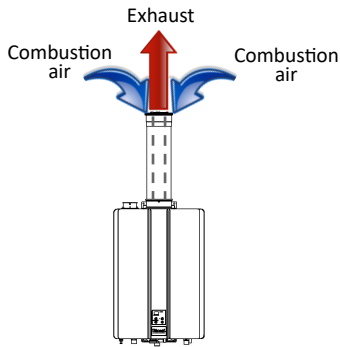

Twin Pipe

Combustion air and exhaust vent directly through separate penetrations.

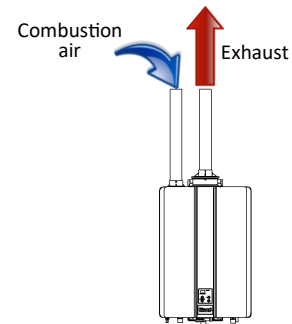

2 Non-Direct Vent *(Room Air and External)*

Room Air

Room air is used for combustion while exhaust vents to the outside.

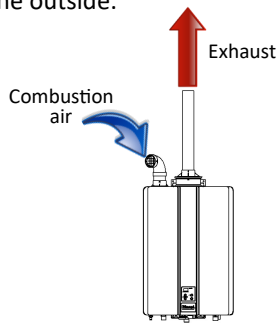

External (Outdoor)

External (outdoor) water heater.

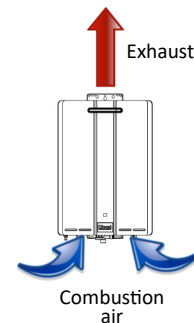

3 Common Vent *(Indoor Units Only. Direct Vent and Non-Direct/Room Air Vent)*

Direct Vent

Multiple water heaters sharing a combustion air header and a separate exhaust header that vents directly through separate penetrations to the outside.

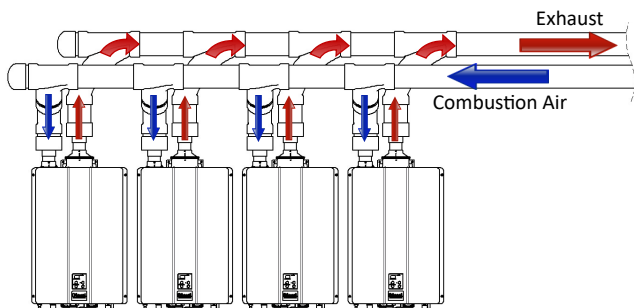

Non-Direct (Room Air) Vent

Multiple water heaters using room air for combustion while sharing an exhaust header that vents directly to the outside.

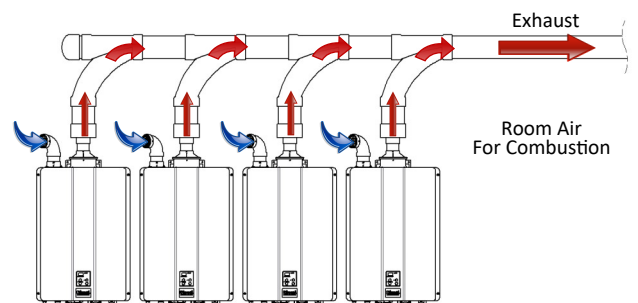







1 Direct Vent *(Concentric Pipe and Twin Pipe)*

Direct Vent Approved Vent Manufacturers and Products







Following is a list of vent components and terminations for Direct Vent installations. Install the correct venting for your model according to the venting manufacturer's instructions and the guidelines below. The information below is correct at time of publication and is subject to change without notice. Contact the vent manufacturer for questions related to the vent system, products, part numbers and instructions.



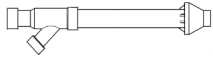
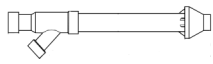
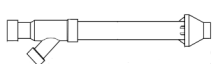





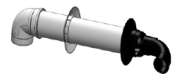

Manufacturer	Phone	Web Site
Ubbink	800-621-9419	www.rinnai.us
Centrotherm	877-434-3432	www.centrotherm.us.com
Heat-Fab	800-772-0739	www.heatfab.com
Metal Fab	800-835-2830	www.metal-fabinc.com
IPEX	U.S.: 800-463-9572 Canada: 866-473-9462	www.ipexamerica.com www.ipexinc.com
DuraVent	800-835-4429	www.duravent.com
Royal	800-232-5690	www.royalbuildingproducts.com
Ecco Manufacturing	877-955-4805	www.eccomfg.com
DiversiTech	800-995-2222	www.diversitech.com

Manufacturer	Manufacturer Part Number	Product Description	Diagram	Horizontal	Vertical	Equivalent Length (ft)
2 in./4 in. CONCENTRIC VENT TERMINATIONS						
UBBINK	229011NPP	2/4 Condensing Horizontal Termination Kit 8.7 in.		✓		5
	229012NPP	2/4 Condensing Horizontal Termination Kit 12 in.				
	229013NPP	2/4 Condensing Horizontal Termination Kit 21 in.				
	224356NPP	2/4 Condensing Roof Discharge Termination 20 in. above roof			✓	5
	710202NPP	2/4 Condensing 90 Degree Diverter Nose <i>(Use with Wall Terminal)</i>		✓		5
710215NPP	2/4 Condensing 45 Degree Diverter Nose <i>(Use with Wall Terminal)</i>		✓		5	
IPEX	196005, 197040	FGV Concentric Vent Kit (16 in. length)		✓	✓	20
	196105, 197033	FGV Concentric Vent Kit (28 in. length)		✓	✓	20
	196125	FGV Concentric Vent Kit (40 in. length)		✓	✓	20

1



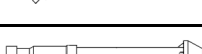
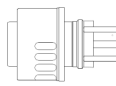





Direct Vent *(Concentric Pipe and Twin Pipe)*

Manufacturer	Manufacturer Part Number	Product Description	Diagram	Horizontal	Vertical	Equivalent Length (ft)
2 in./4 in. CONCENTRIC VENT TERMINATIONS <i>(Continued)</i>						
ROYAL	52CVKGV6502	PVC Concentric Vent Kit 2 in. x 16 in.		✓	✓	20
	52CVKGV6502-28	PVC Concentric Vent Kit 2 in. x 28 in.		✓	✓	20
	52CVKGV6502-40	PVC Concentric Vent Kit 2 in. x 40 in.		✓	✓	20
CENTROTHERM	ICRT2439	2 in. x 4 in. Concentric Roof Termination			✓	20
DURAVENT	2PPS-VKL/VK-TCL	2 in. x 4 in. Vertical Termination Cap Kit-Concentric			✓	20
	2PPS-HKL	2 in. x 4 in. Horizontal Termination Kit-Concentric		✓		20
ECCO	190288	2 in. x 4 in. Concentric Horizontal Termination		✓		5
	190295	2 in. x 4 in. Concentric Vertical Termination			✓	5
DIVERSITECH	CVENT-2	2 in. x 4 in. Concentric Horizontal Termination		✓	✓	20

Manufacturer	Manufacturer Part Number	Product Description	Diagram	Horizontal	Vertical	Equivalent Length (ft)
3 in./5 in. CONCENTRIC VENT TERMINATIONS						
UBBINK	223174PP	3/5 Condensing Horizontal Termination Kit 8.7 in.		✓		5
	223176PP	3/5 Condensing Horizontal Termination Kit 12 in.				
	223177PP	3/5 Condensing Horizontal Termination Kit 21 in.				
	223186PP	3/5 Condensing Horizontal Diverter Termination Kit 19 in.		✓		16
	224047PP	3/5 Condensing Raised Horizontal Termination Kit		✓		24
	184162PP	3/5 Condensing Roof Discharge Termination 20 in. above roof			✓	5
IPEX	196006, 197009	FGV Concentric Vent Kit 3 in. x 20 in.		✓	✓	20
	196106, 197107	FGV Concentric Vent Kit 3 in. x 32 in.		✓	✓	20
	196116, 197117	FGV Concentric Vent Kit 3 in. x 44 in.		✓	✓	20
ROYAL	52CVKGV6503 (PVC)/ 52CVKGV9003 (CPVC)	PVC/CPVC Concentric Vent Kit 3 in. x 20 in.		✓	✓	20
	52CVKGV6503-32 (PVC)/ 52CVKGV9003-32 (CPVC)	PVC/CPVC Concentric Vent Kit 3 in. x 32 in.		✓	✓	20
	52CVKGV6503-44 (PVC)/ 52CVKGV9003-44 (CPVC)	PVC/CPVC Concentric Vent Kit 3 in. x 44 in.		✓	✓	20
HEAT-FAB	SC03HT	Horizontal Termination Adapter		✓		20
	SC03VT	Vertical Termination Adapter			✓	20
CENTRO-THERM	ICRT3539	3"/5" Concentric Roof Termination PPs-UV			✓	20











1

Direct Vent (Concentric Pipe and Twin Pipe)

Manufacturer	Manufacturer Part Number	Product Description	Diagram	Horizontal	Vertical	Equivalent Length (ft)
3 in./5 in. CONCENTRIC VENT TERMINATIONS (Continued)						
METAL-FAB	3CGRLSV	Vertical Adapter			✓	1
	3CGRLSH	Horizontal Adapter		✓		6
	3CGRVT	Vertical Termination			✓	5
	3CGRHT	Horizontal Termination		✓		16
DURAVENT	3PPS-VKL/VK-TCL	3 in. x 5 in. Vertical Termination Cap Kit-Concentric			✓	20
	3PPS-HKL	3 in. x 5 in. Horizontal Termination Kit-Concentric		✓		20
ECCO	190388	3 in. x 5 in. Concentric Horizontal Termination		✓		5
	190395	3 in. x 5 in. Concentric Vertical Termination			✓	5
DIVERSITECH	CVENT-3	3 in. x 5 in. Concentric Horizontal Termination		✓	✓	20

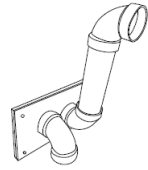









1

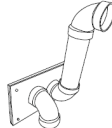

Direct Vent (Concentric Pipe and Twin Pipe)

Manufacturer	Manufacturer Part Number	Product Description	Diagram	Horizontal	Vertical	Equivalent Length (ft)
2 in. TWIN PIPE TERMINATIONS						
CENTROTHERM	ISELL0287UV	2 in. 87° Long PPS-UV		✓		6
	ISTT0220	2 in. Termination Tee		✓		6
	ISLPT0202	2 in. Low Profile Wall Termination		✓		5
DURAVENT	2PPS-HTPL	2 in. Twin Pipe Termination		✓		10
	2PPS-HSTL	2 in. Single Horizontal Termination		✓		6
	2PPS-TBL	2 in. Black UV Resistant Tee		✓		5
IPEX	196984	FGV PVC Low Profile Termination Kit		✓		5
	081216	FGV PVC Wall Termination Kit		✓		16
ROYAL	52SWVKGVS6502	PVC Side Wall Vent Kits		✓		5
	52WTVKGVS6502	PVC Wall Vent Kits		✓		16
DIVERSITECH	HVENT-2	2 in. Low Profile Horizontal Vent Kit		✓		5

1

Direct Vent (Concentric Pipe and Twin Pipe)

Manufacturer	Manufacturer Part Number	Product Description	Diagram	Horizontal	Vertical	Equivalent Length (ft)
3 in. TWIN PIPE TERMINATIONS						
CENTROTHERM	ISELL0387UV	3 in. 87° Long PPS-UV		✓		6
	ISTT0320	3 in. Termination Tee		✓		6
	ISLPT0303	3 in. Low Profile Wall Termination		✓		5
DURAVENT	3PPS-HTPL	3 in. Twin Pipe Termination		✓		10
	3PPS-HSTL	3 in. Single Horizontal Termination		✓		5
	3PPS-TBL	3 in. Black UV Resistant Tee		✓		6
IPEX	196985	FGV PVC Low Profile Termination Kit		✓		5
	081219	FGV PVC Wall Termination Kit		✓		16
ROYAL	52SWVKGVS6503	PVC Side Wall Vent Kits		✓		5
	52WTVKGVS6503	PVC Wall Vent Kits		✓		16
DIVERSITECH	HVENT-3	3 in. Low Profile Horizontal Vent Kit		✓		5

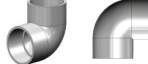
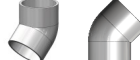
VARIOUS 2 in. OR 3 in. SCHEDULE 40 PVC/CPVC TERMINATIONS						
Air Filter Screen			✓	✓		N/A
Tee			✓	✓		5
90° Elbow			✓	✓		5
45° Elbow			✓	✓		2.5

1 Direct Vent (Concentric Pipe and Twin Pipe)

Direct Vent Termination Clearances (For Concentric and Twin Pipe)

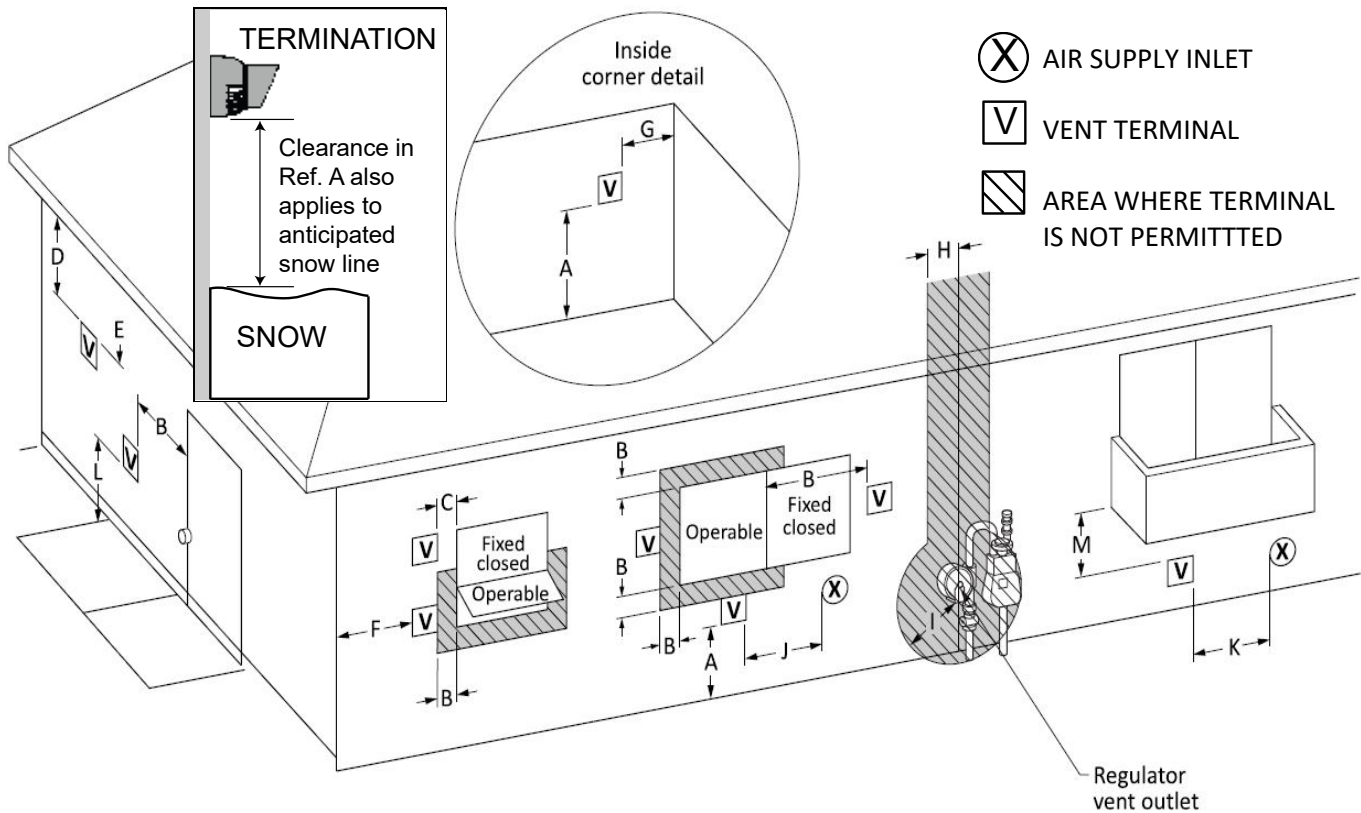

Ref	Description	Canadian Installations (CSA B149.1)	U.S. Installations (ANSI Z223.1 /NFPA 54)
		Direct Vent (Indoor Unit)	Direct Vent (Indoor Unit)
A	Clearance above grade, veranda, porch, deck, or balcony	12 in. (30 cm)	12 in. (30 cm)
B	Clearance to window or door that may be opened	36 in. (91 cm)	12 in. (30 cm)
C	Clearance to permanently closed window	*	*
D	Vertical clearance to ventilated soffit, located above the terminal within a horizontal distance of 2 ft (61 cm) from the center line of the terminal	*	*
E	Clearance to unventilated soffit	*	*
F	Clearance to outside corner	*	*
G	Clearance to inside corner	*	*
H	Clearance to each side of center line extended above meter/regulator assembly	*	*
I	Clearance to service regulator vent outlet	Above a regulator within 3 ft (91 cm) horizontally of the vertical center line of the regulator vent outlet to a maximum vertical distance of 15 ft (4 m)	*
J	Clearance to non-mechanical air supply inlet to building or the combustion air inlet to any other appliance	36 in. (91 cm)	12 in. (30 cm)
K	Clearance to a mechanical air supply inlet	6 ft (1.83 m)	3 ft (91 cm) above if within 10 ft (3 m) horizontally
L	Clearance above paved sidewalk or paved driveway located on public property	7 ft (2.13 m) [1]	*
M	Clearance under veranda, porch, deck, or balcony	12 in. (30 cm) [2]	*

Clearance to opposite wall is 24 in. (60 cm).

- [1] A vent shall not terminate directly above a sidewalk or paved driveway that is located between two single family dwellings and serves both dwellings.
 [2] Permitted only if veranda, porch, deck, or balcony is fully open on a minimum of two sides beneath the floor.

* Clearances are in accordance with local installation codes and the requirements of the gas supplier. (*Dégagement conforme aux codes d'installation locaux et aux exigences du fournisseur de gaz.*)

1 Direct Vent (Concentric Pipe)

Concentric Pipe Overview

Combustion air and exhaust vent directly through a single concentric connection. Hot exhaust exits through the interior tube, while combustion air enters through the outer layer.

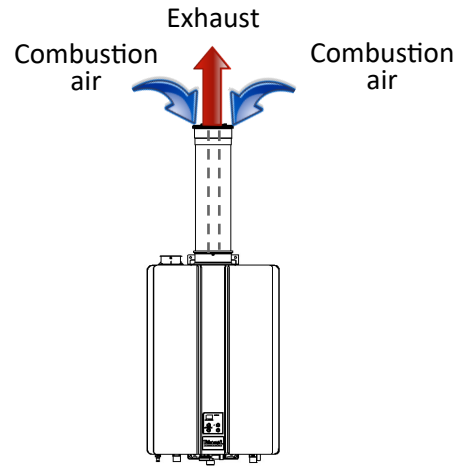

Concentric Pipe Termination Clearances

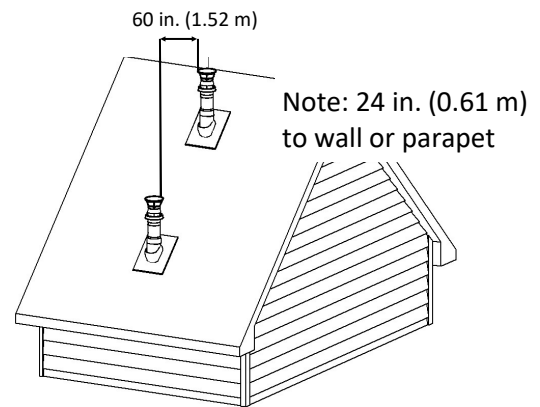
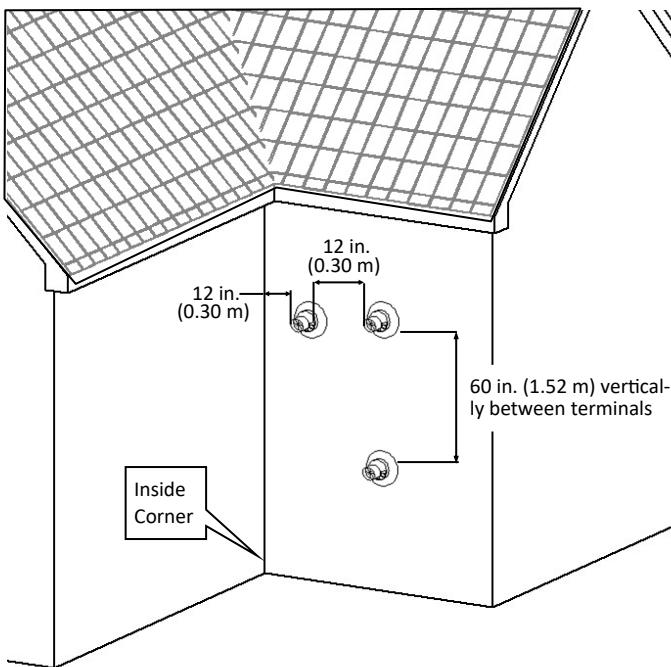

Between terminals at different levels

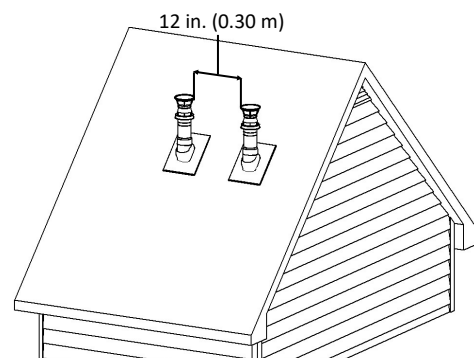

Between terminals at same level

All terminations (horizontal and/or vertical) must terminate 12 in. (0.30 m) above grade or anticipated snow level.

1 Direct Vent (Concentric Pipe)

Concentric Pipe Installation Instructions

- 1 Remove and discard screw from concentric flue connection.

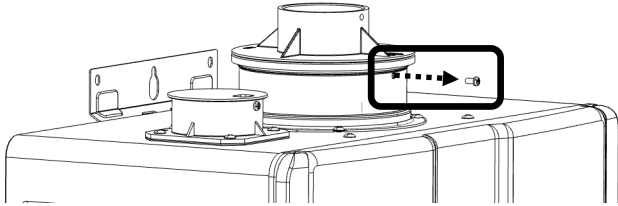

- 2 Remove exhaust adapter ring (discard for concentric venting configurations).

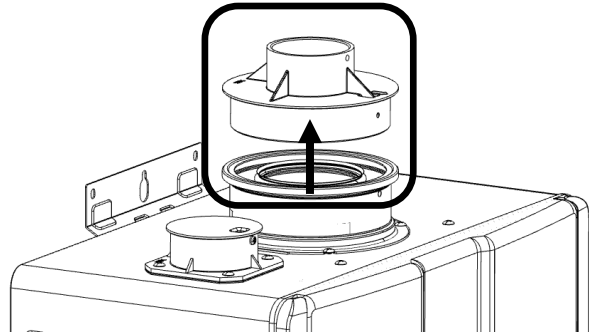

- 3 Install the concentric vent. Ensure it is properly seated.

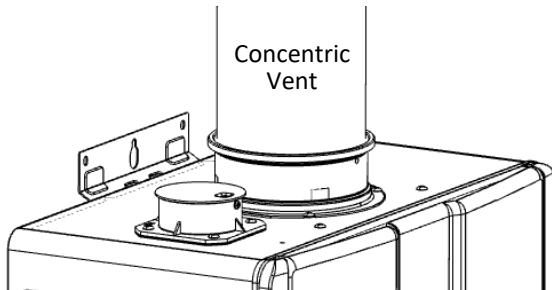

- 4 Secure the vent pipe to the concentric flue connection with the supplied screw.

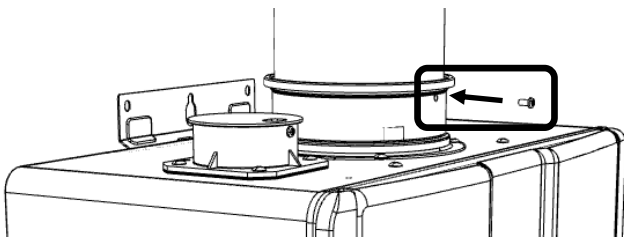

Mount Concentric Pipe Through Wall

If venting through an exterior wall, align the wall mounting bracket template (located in literature bag) to the wall and follow the instructions on the template for appropriate vent hole location. Use a level to make sure the wall mounting bracket is even and level.

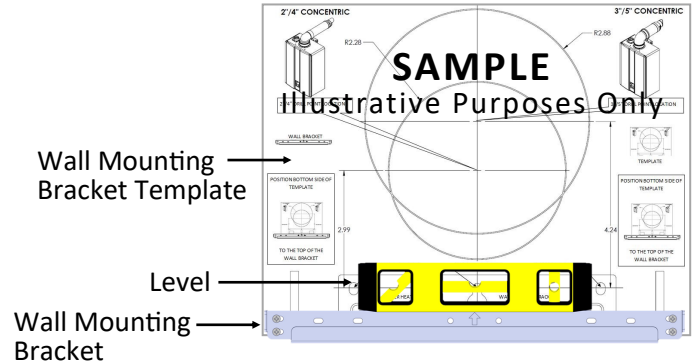

Concentric Pipe Example Vent Applications

Horizontal Wall Terminations	Vertical Roof Terminations
2 in. x 4 in. 	2 in. x 4 in. and 3 in. x 5 in.
3 in. x 5 in. 	

Concentric Pipe Maximum Vent Length

Concentric Vent Maximum Equivalent Length		
Vent Sizes	2 in. X 4 in.	3 in. X 5 in.
Vent Lengths	65 ft (20 m)	150 ft (46 m)
<ul style="list-style-type: none"> • 45° elbow is equivalent to 3 ft (1 m) • 90° elbow is equivalent to 6 ft (2 m) 		

Important: Install the venting termination according to the diagrams and instructions in this manual. Slope the venting 1/4 in. per foot toward the appliance according to the vent manufacturer's installation instructions. Dispose of condensate per local codes.

1 Direct Vent (Twin Pipe)

Twin Pipe Overview

Combustion air and exhaust vent directly through separate penetrations.

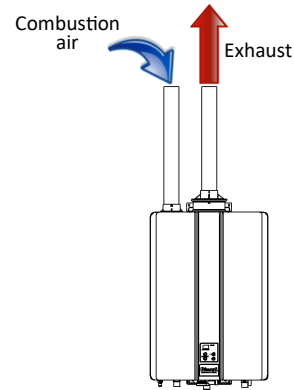

Twin Pipe Termination Clearances

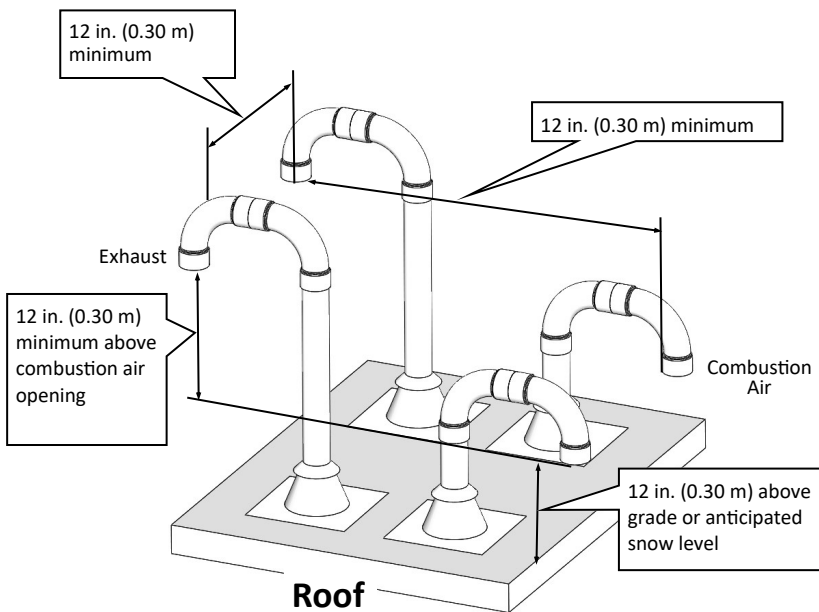

Twin Pipe Vertical Termination of Multiple Water Heaters

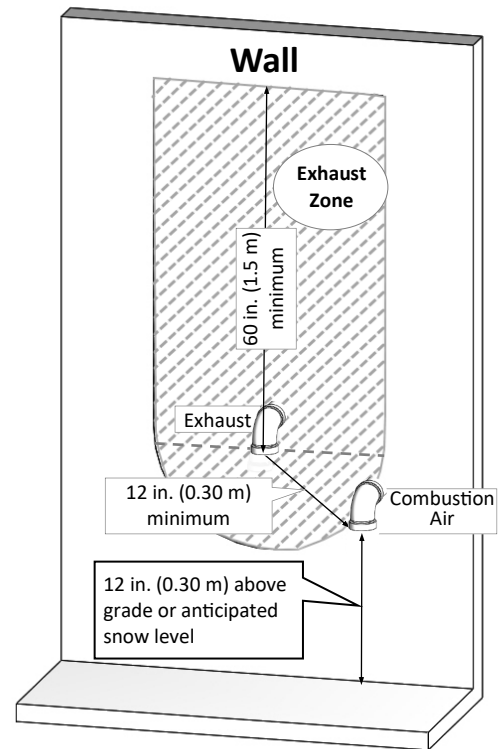

Combustion air termination not permitted in shaded area 

Horizontal Vent and Combustion Air Piping

For illustration purposes only. Listed equivalent length is based on worst case scenario of 3 X 90° elbows or 18 equivalent ft.

1 Direct Vent (Twin Pipe)

Twin Pipe Installation Instructions

The water heater is equipped with a 2 in. (51 mm) pipe connection. With the use of a pipe reducer, installers can use a 3 in. (76 mm) pipe for the combustion air and exhaust.

! WARNING

DO NOT apply PVC glues, solvents, or cleaners to the water heater's combustion air or exhaust gasket connections. Failure to correctly assemble the components according to these instructions may result in property damage, personal injury, or death.

- 1 Remove and discard the screw from the combustion air vent connection.

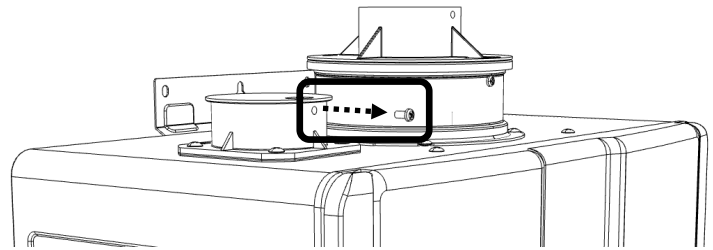

- 2 Remove and discard the combustion air vent cap.

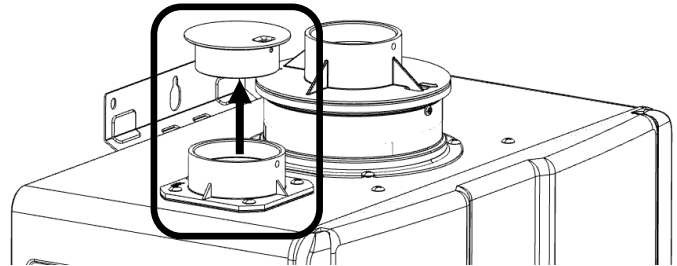

- 3 Install the combustion air vent pipe. Ensure it is properly seated.

Secure the combustion air vent pipe to the combustion air vent connection with the supplied screw.

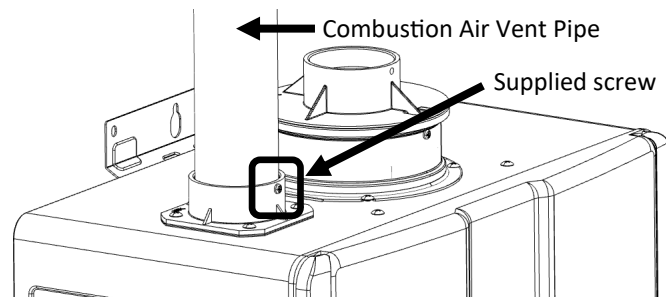

- 4 Install the exhaust vent pipe. Ensure it is properly seated.

Secure the exhaust vent pipe to the exhaust adapter ring with the supplied screw.

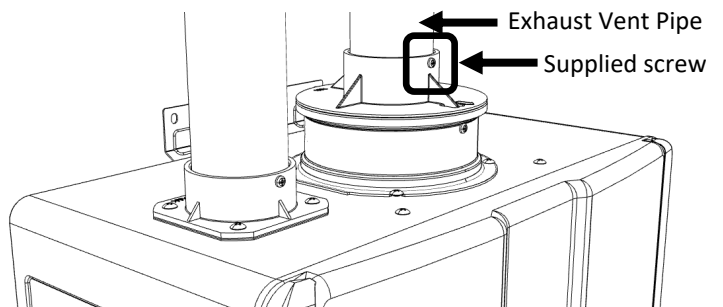



1

Direct Vent (Twin Pipe)

Twin Pipe Example Vent Applications

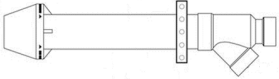
Slope horizontal exhaust 1/4 in. per foot towards the water heater. DO NOT slope combustion air pipe towards the water heater.

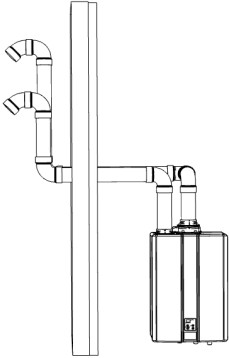
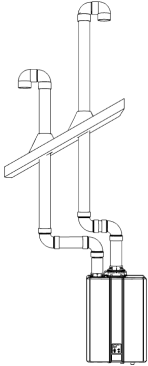
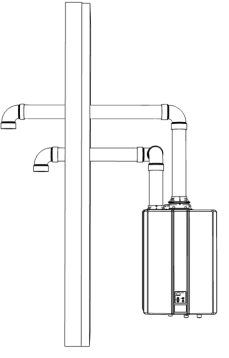
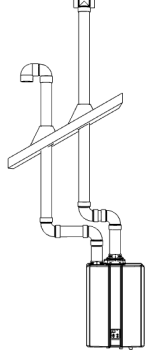
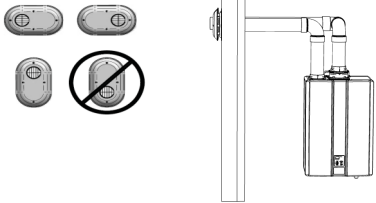
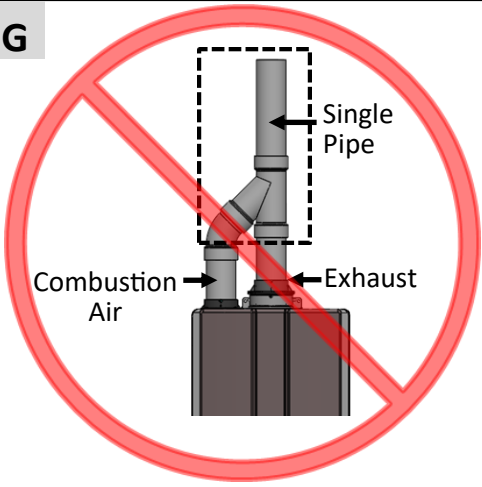
<p>This configuration requires the use of a Concentric Vent Termination</p> <p>2 in. or 3 in. PVC/CPVC IPEX / Royal Concentric Side Wall Termination Configuration</p> 	<p>This configuration requires the use of a Concentric Vent Termination</p> <p>2 in. or 3 in. PVC/CPVC IPEX / Royal Concentric Vertical Termination Configuration</p> 
<p>2 in. or 3 in. Schedule 40 PVC/CPVC Snorkel Termination Configuration</p> 	<p>2 in. or 3 in. Schedule 40 PVC/CPVC Standard upside down "U" Vertical Termination Configuration</p> 
<p>2 in. or 3 in. Schedule 40 PVC/CPVC Elbow or Tee Side Wall Termination Configuration</p> 	<p>2 in. or 3 in. Schedule 40 PVC/CPVC Tee Vertical Termination Configuration</p> 
<p>2 in. or 3 in. PVC Low Profile Termination Configuration</p> 	<p>WARNING</p> <p>Exhaust and combustion air MUST NOT be brought together into a single PVC pipe using a pipe fitting.</p> 

Twin Pipe Maximum Vent Length

Twin Pipe Maximum Equivalent Length Table		
Vent Sizes	2 in. (51 mm)	3 in. (76 mm)
Vent Lengths	65 ft (20 m)	150 ft (46 m)
<ul style="list-style-type: none"> 45° elbow is equivalent to 3 ft (1 m) 90° elbow is equivalent to 6 ft (1.83 m) 		

2 Non-Direct Vent (Room Air and External)

Room Air and External Termination Clearances

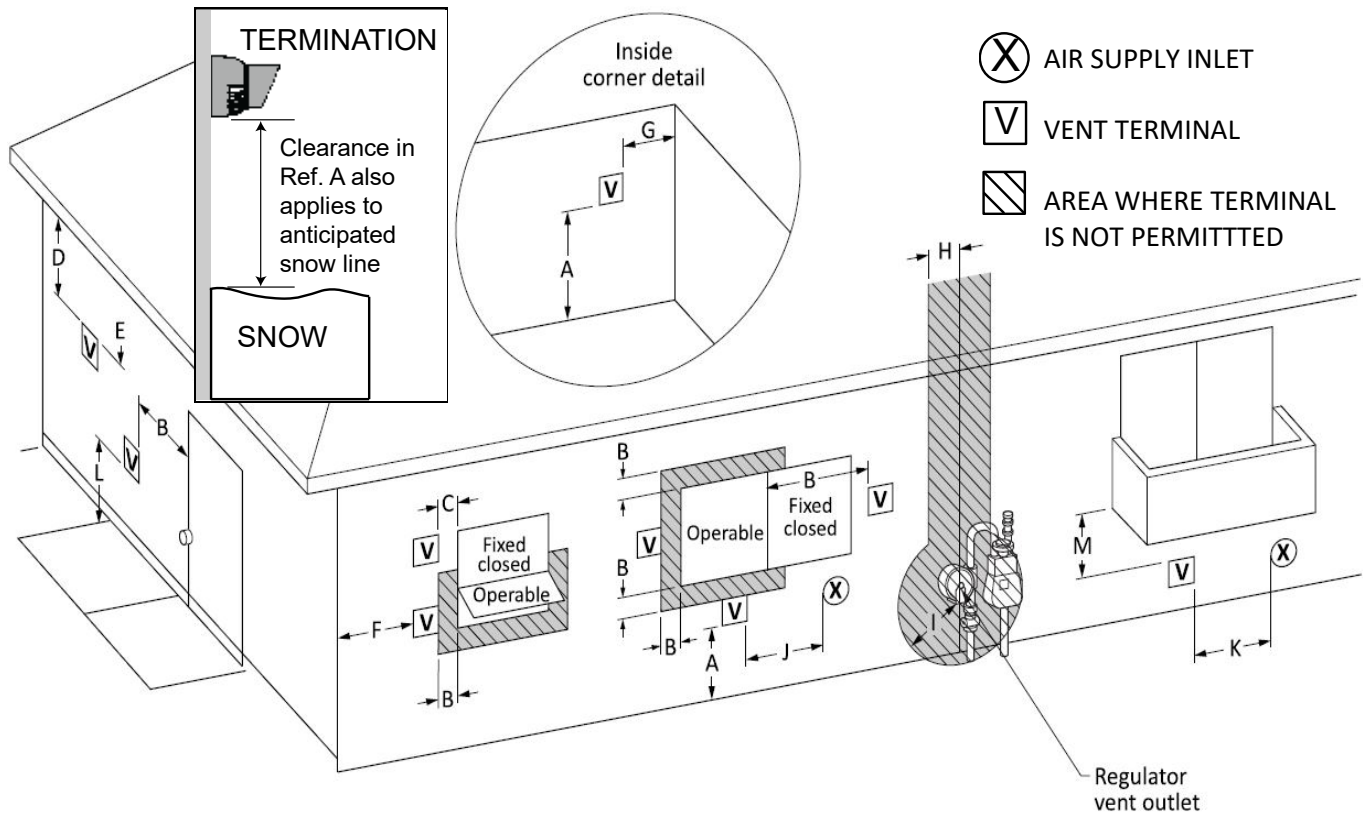

Ref	Description	Canadian Installations (CSA B149.1)	U.S. Installations (ANSI Z223.1 /NFPA 54)
		Other than direct vent (Outdoor unit and/or Room Air)	Other than direct vent (Outdoor unit and/or Room Air)
A	Clearance above grade, veranda, porch, deck, or balcony	12 in. (30 cm)	12 in. (30 cm)
B	Clearance to window or door that may be opened	36 in. (91 cm)	4 ft (1.2 m) below or to side of opening; 1 ft (300 mm) above opening
C	Clearance to permanently closed window	*	*
D	Vertical clearance to ventilated soffit, located above the terminal within a horizontal distance of 2 ft (61 cm) from the center line of the terminal	*	*
E	Clearance to unventilated soffit	*	*
F	Clearance to outside corner	*	*
G	Clearance to inside corner	*	*
H	Clearance to each side of center line extended above meter/regulator assembly	*	*
I	Clearance to service regulator vent outlet	Above a regulator within 3 ft (91 cm) horizontally of the vertical center line of the regulator vent outlet to a maximum vertical distance of 15 ft (4 m)	*
J	Clearance to non-mechanical air supply inlet to building or the combustion air inlet to any other appliance	36 in. (91 cm)	4 ft (1.2 m) below or to side of opening; 1 ft (300 mm) above opening
K	Clearance to a mechanical air supply inlet	6 ft (1.83 m)	3 ft (91 cm) above if within 10 ft (3 m) horizontally
L	Clearance above paved sidewalk or paved driveway located on public property	7 ft (2.13 m) [1]	*
M	Clearance under veranda, porch, deck, or balcony	12 in. (30 cm) [2]	*

Clearance to opposite wall is 24 in. (60 cm).

- [1] A vent shall not terminate directly above a sidewalk or paved driveway that is located between two single family dwellings and serves both dwellings.
 [2] Permitted only if veranda, porch, deck, or balcony is fully open on a minimum of two sides beneath the floor.

* Clearances are in accordance with local installation codes and the requirements of the gas supplier. (*Dégagement conforme aux codes d'installation locaux et aux exigences du fournisseur de gaz.*)

NOTE: Installation of Non-Direct Vent (Room Air) must use listed category IV venting.

NOTE: All terminations (horizontal and/or vertical) must terminate 12 in. above grade or anticipated snow level.

Termination Clearances for External (Outdoor) Water Heaters

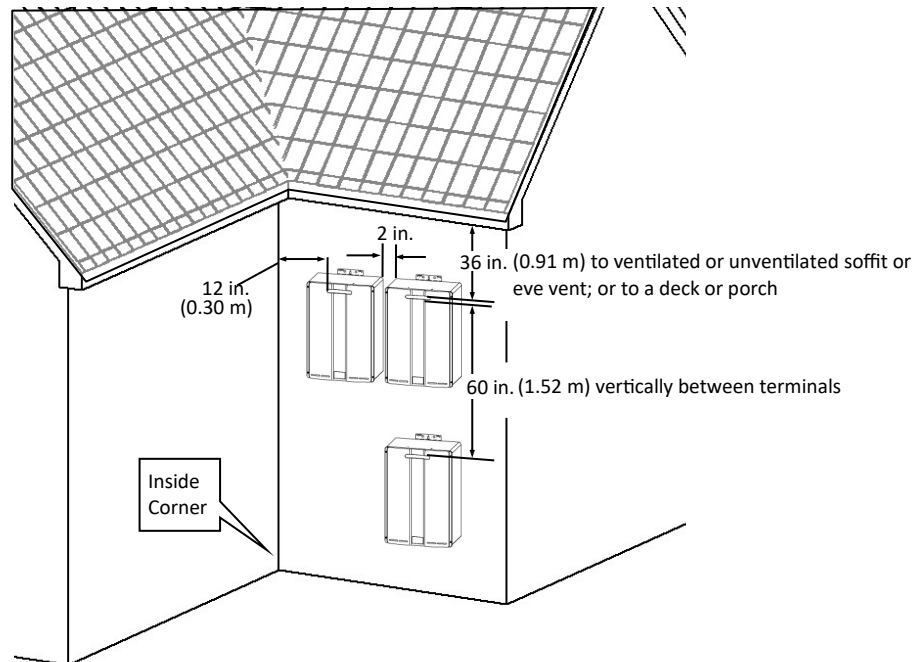

Exhaust Termination Clearances for Internal (Indoor) Room Air Applications

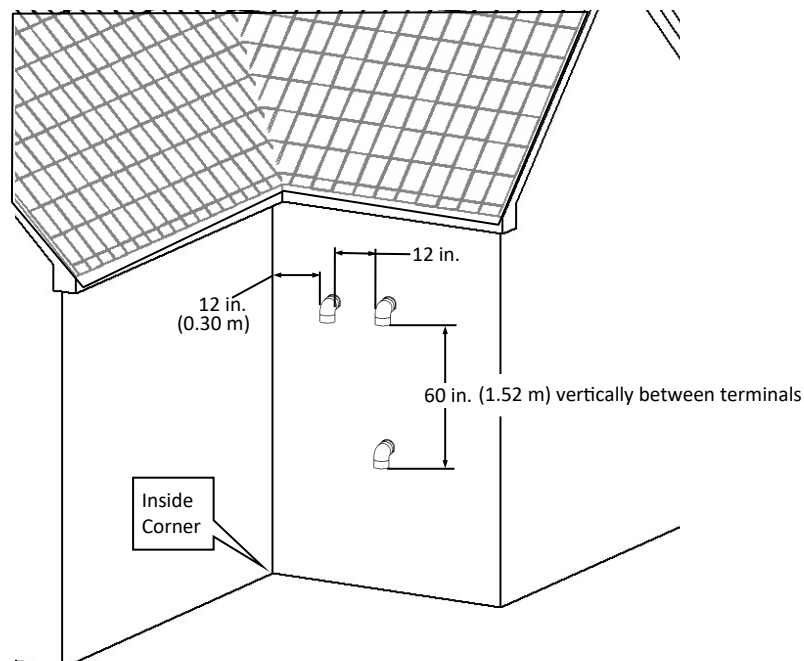

Combustion Air

WARNING

This water heater requires adequate combustion air for ventilation and dilution of flue gases. Failure to provide adequate combustion air can result in unit failure, fire, explosion, serious bodily injury or death. Use the following methods to ensure adequate combustion air is available for correct and safe operation of this water heater.

Important: Combustion air must be free of corrosive chemicals. Do not provide combustion air from corrosive environments. Appliance failure due to corrosive air is not covered by warranty.

For applications containing corrosive indoor air, this appliance must be installed as direct vent. DO NOT use room air in applications where combustion air contains acid forming chemicals such as sulfur, fluorine and chlorine. These chemicals have been found to cause rapid damage and decay and can become toxic when used as combustion air in gas appliances. Such chemicals can be found in, but not limited to bleach, ammonia, cat litter, aerosol sprays, cleaning solvents, varnish, paint and air fresheners. Do not store these products or similar products in the vicinity of this water heater.

Unconfined Space

An unconfined space is defined in *National Fuel Gas Code, ANSI Z223.1/NFPA 54* as "a space whose volume is not less than 50 cubic feet per 1000 Btu/hr (4.8 m³ per kW per hour) of the aggregate input rating of all appliances installed in that space. Rooms communicating directly with the space in which the appliances are installed, through openings not furnished with doors, are considered a part of the unconfined space." If the "unconfined space" containing the appliance(s) is in a building with tight construction, additional outside air may be required for proper operation. Outside air openings should be sized the same as for a confined space.

Confined Space

A confined space is defined in the *National Fuel Gas Code, ANSI Z223.1/NFPA 54* as "a space whose volume is less than 50 cubic feet per 1000 Btu/hr (4.8 m³ per kW per hour) of the aggregate input rating of all appliances installed in that space." Examples include a small room, closet, alcove, utility room, etc. A confined space must have two combustion air openings. Size the combustion air openings based on the BTU input for all gas utilization equipment in the space and the method by which combustion air is supplied.

Using Indoor Air For Combustion: When using air from other room(s) in the building, the total volume of the room(s) must be of adequate volume (Greater than 50 cubic feet per 1000 Btu/hr). Combustion air openings between joining rooms must have at least 1 square inch of free area for each 1000 Btu/h, but not less than 100 square inches each.

Using Outdoor Air For Combustion

Outdoor air can be provided to a confined space through two permanent openings, one commencing within 12 in. (0.30 m) of the top and one commencing within 12 in. (0.30 m) of the bottom, of the confined space. The openings shall communicate to the outside by one of two ways.

When communicating directly with the outdoors through horizontal ducts, each opening shall have a minimum free area of 1 in²/2000 Btu/hr (1100 mm²/kW) of total input rating of all appliances in the confined space.

Note: If ducts are used, the cross sectional area of the duct must be greater than or equal to the required free area of the openings to which they are connected.

*Combustion Air (Continued)***Louvers and Grills**

When sizing the permanent opening consideration must be taken for the design of the louvers or grills to maintain the required free area required for all gas utilizing equipment in the space. If the free area of the louver or grill design is not available, assume wood louvers will have 25% free area and metal louvers or grills will have 75% free area. Under no circumstance should the louver, grill or screen have openings smaller than 1/4 in.

Example: Wood: 10 in x 12 in x 0.25 = 30 in²

Metal: 10 in x 12 in x 0.75 = 90 in²

Location

To maintain proper circulation of combustion air two permanent openings (one upper, one lower) must be positioned in confined spaces. The upper shall be within 12 in. (0.30 m) of the top of the confined space and the lower opening shall be within 12 in. (0.30 m) of the bottom of the confined space. Openings must be positioned as to never be obstructed.

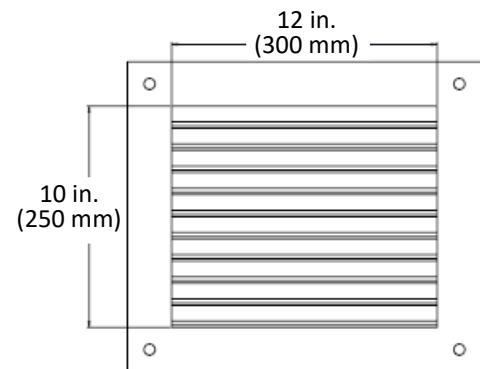
**NOTICE**

Combustion air provided to the appliance should not be taken from any area of the structure that may produce a negative pressure (i.e. exhaust fans, powered ventilation fans).

WARNING

TO PREVENT POSSIBLE PERSONAL INJURY OR DEATH DUE TO ASPHYXIATION, COMMON VENTING WITH OTHER MANUFACTURER'S INDUCED DRAFT APPLIANCES IS NOT ALLOWED.

Checklist for Combustion Air and Venting Requirements

- Verify all combustion air opening sizes are correct.
- Ensure that the Combustion Air Requirements are followed that will provide sufficient combustion air for the appliance.
- DO NOT use room air for combustion in applications where the indoor air is corrosive.
- Verify that adequate combustion air is available for all appliances installed in the space.
- Installation complies with *National Fuel Gas Code, ANSI Z223.1/NFPA 54* as well as local and state regulations therein.

2 Non-Direct Vent (Room Air)

Non-Direct Vent (Room Air) Installation Instructions

- 1 Remove and discard screw from combustion air vent connection.

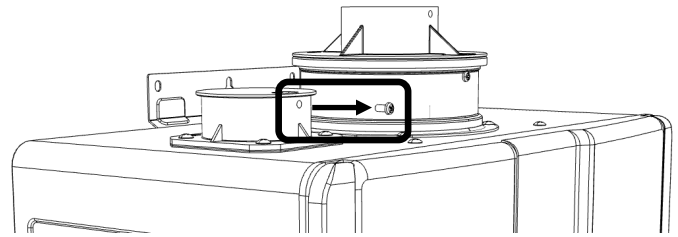

- 2 Remove and discard the combustion air vent cap.

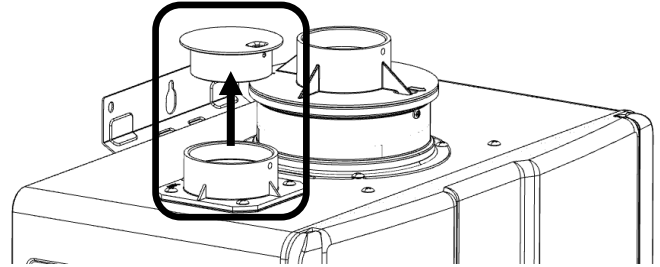

- 3 Install the combustion air vent pipe. Ensure it is properly seated.

Secure the combustion air vent pipe to the combustion air vent connection with the supplied screw.

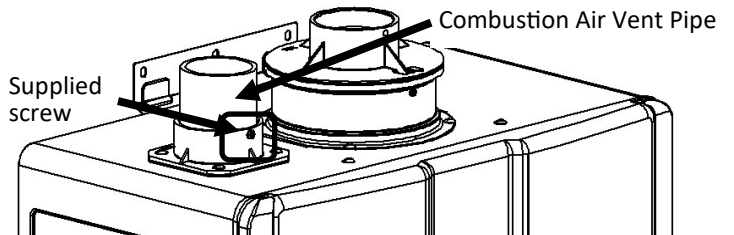

- 4 Place the vent screen or room air screen inside elbow and secure with the supplied screw. Use the room air screen for environments where room air is dusty.

Note:

- 2 in. vent screen supplied with water heater.
- Room air screen is available as an accessory.

Glue elbow to the combustion air PVC vent pipe per manufacturer's instructions.

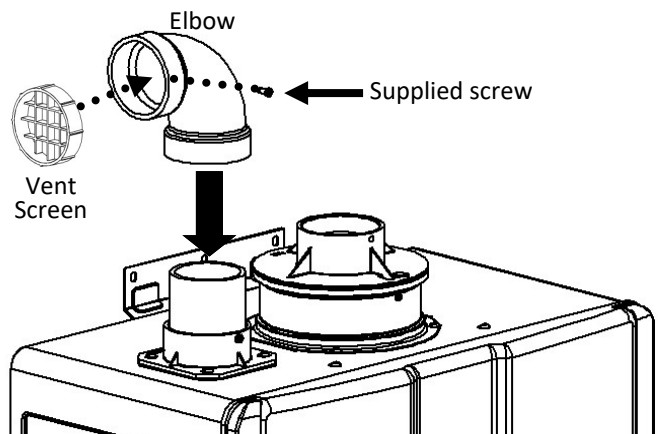

- 5 Install the exhaust vent pipe. Ensure it is properly seated. Secure the exhaust vent pipe to the exhaust adapter ring with the supplied screw.

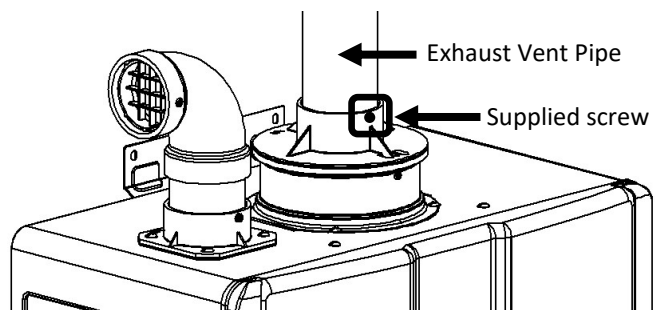

Non-Direct Vent (Room Air) Example Vent Applications

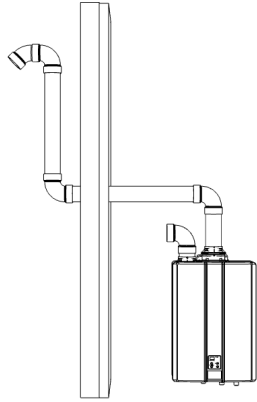
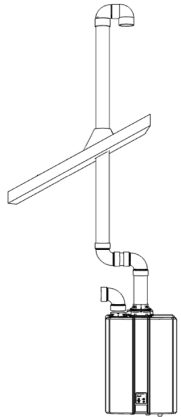
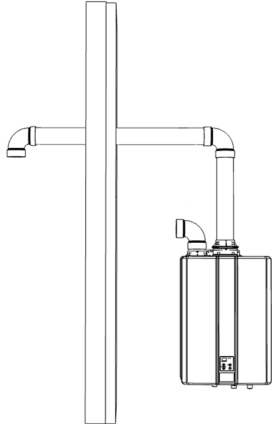
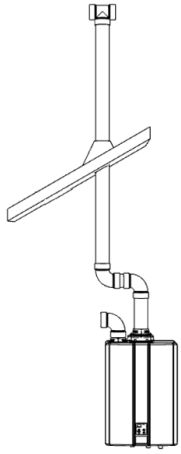
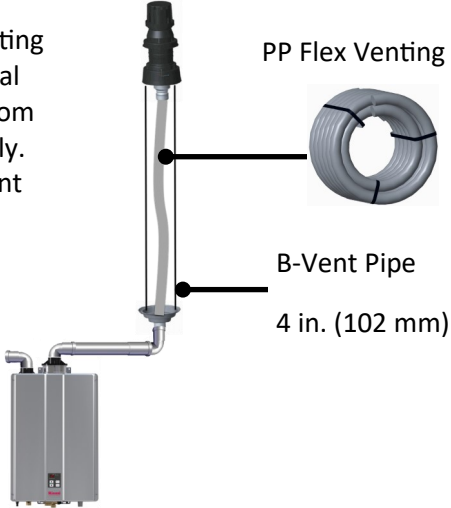
<p>2 in. or 3 in. Schedule 40 PVC/CPVC Snorkel Termination Configuration</p> 	<p>2 in. or 3 in. Schedule 40 PVC/CPVC Standard Upside Down "U" Vertical Termination Configuration</p> 
<p>2 in. or 3 in. Schedule 40 PVC/CPVC Elbow or Tee Side Wall Termination Configuration</p> 	<p>2 in. or 3 in. Schedule 40 PVC/CPVC Tee Vertical Termination Configuration</p> 
<p>Ubbink flexible venting approved for vertical non-direct vent (room air) applications only. Refer to the flex vent manual for further details.</p>  <p>PP Flex Venting</p> <p>B-Vent Pipe</p> <p>4 in. (102 mm)</p>	

Slope horizontal exhaust 1/4 in. per foot towards the water heater.

Non-Direct Vent (Room Air) Maximum Vent Length

Room Air Maximum Equivalent Length Table			
Vent Sizes	2 in. (51 mm)	3 in. (76 mm)	2 in. (51 mm) Ubbink Flex
Vent Lengths	65 ft (20 m)	150 ft (46 m)	50 ft (15 m)
<ul style="list-style-type: none"> 45° elbow is equivalent to 3 ft (1 m) 90° elbow is equivalent to 6 ft (2 m) 			

Common venting allows multiple Rinnai Tankless Water Heaters to share the same vent system.

Rinnai water heaters can only be common vented with Schedule 40 PVC/CPVC or with the Rinnai certified common vent system.

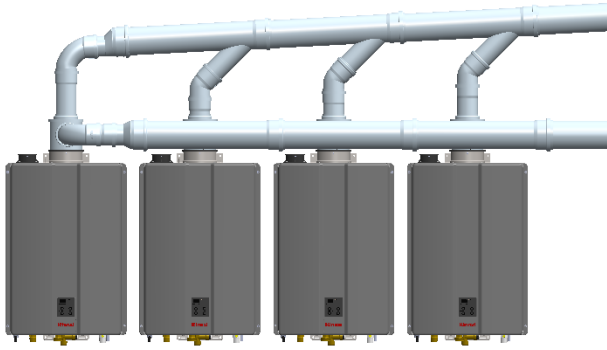

Example: Rinnai Common Venting

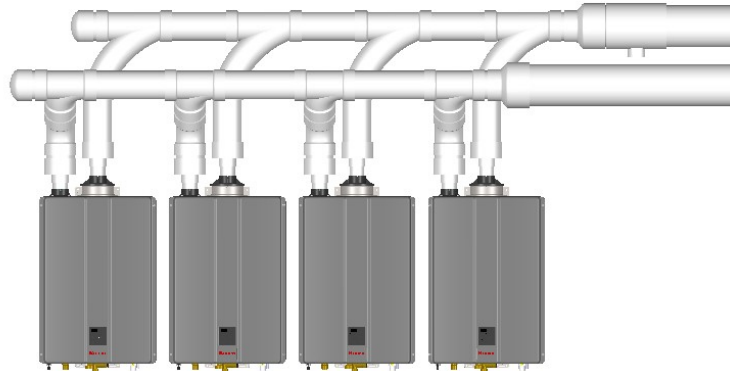

*Example: Schedule 40 PVC/CPVC
Common Venting*

General Guidelines

When installing Common Vent, follow these guidelines:

- Use only the materials listed in this manual for vent, air intake pipe, and fittings. Failure to comply with this warning could result in property damage, personal injury, or death.
- When cutting vent components, ensure that the cuts are straight.
- Chamfer and deburr all edges before installing the components.
- Vent joints must not leak. Confirm gas tight connections of every vent joint.
- Before operating the water heater(s), ensure vent system is clean and free of debris.
- Vent system must be supported according to the vent manufacture's installation instructions.
- Venting should be as direct as possible with a minimum number of fittings.
- The common vent system must only be installed by a trained and qualified professional.

COMMON VENT TERMINATION CLEARANCES

- Vent termination per ANSI Z223.1/NFPA 54. For clearances not specified in ANSI Z223.1/NFPA 54, clearances are in accordance with local installation codes and the requirements of the gas supplier.
- Refer to section "3.5 Vent the Water Heater" for additional clearance requirements specific to the installation application.

WARNING

- ❌ DO NOT slope the combustion air pipe toward unit. Failure to comply with this warning could result in property damage, personal injury, or death.
- ❌ DO NOT apply PVC/CPVC glues, solvents, or cleaners to the tankless water heater's intake or exhaust gasket connections. Failure to correctly assemble the components according to these instructions may result in property damage, personal injury, or death.

DO NOT

- ❌ DO NOT obstruct combustion air flow or exhaust gas flow in the venting system.
- ❌ DO NOT install the water heater in an area with negative air pressure.
- ❌ DO NOT combine the common vent system with existing vents, chimneys, or vent pipes connected to other water heaters, boilers or appliances.
- ❌ DO NOT common vent different Rinnai models in a single common vent system.
- ❌ DO NOT use cellular core PVC/CPVC, Radel, ABS or galvanized materials.
- ❌ DO NOT combine vent components from different manufacturers.

Common Vent Maximum Equivalent Vent Lengths

For the table below:

- Header is the main vent pipe into which several vents connect.
- Vent Length is the distance from the end of the header to the vent termination.
- Maximum vent length starts at the end of the header system.
- Use 10 ft (3 m) as equivalent vent length for 90° elbows.
- For use with SENSEI™ internal (indoor) tankless water heaters only.

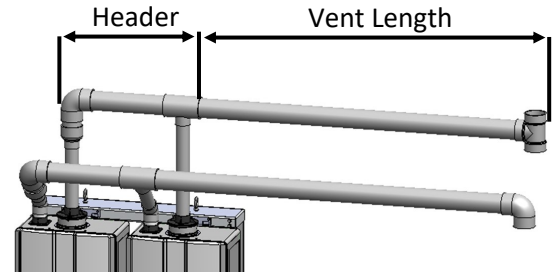

Common Vent Maximum Equivalent Vent Length
Rinnai Common Vent System or Schedule 40 PVC/CPVC

Water Heater Model	# Water Heaters	Max System BTU/HR	HEADER DIAMETER			
			3 in.	4 in.		6 in.
			3 in. Vent Diameter	4 in. Vent Diameter	6 in. Vent Diameter	6 in. Vent Diameter
RU199i (REU-N3237FF-US) CU199i (REU-N3237FFC-US) RUR199i (REU-NP3237FF-US)	2	398,000	65 ft	150 ft	150 ft	150 ft
	3	597,000				
	4	796,000	65 ft	70 ft	90 ft	
	5	995,000				
	6	1,194,000		41 ft		
	7	1,393,000				
	8	1,592,000				
	9	1,791,000				
	10	1,990,000				
	11	2,189,000				
12	2,388,000					
RU160i (REU-N2530FF-US) CU160i (REU-N2530FFC-US) RUR160i (REU-NP2530FF-US)	2	320,000	90 ft	150 ft	150 ft	150 ft
	3	480,000		100 ft		
	4	640,000		65 ft		
	5	800,000				
RU180i (REU-N2934FF-US)	2	360,000	65 ft	150 ft	150 ft	150 ft
	3	540,000				
	4	720,000		65 ft	70 ft	
	5	900,000				
	6	1,080,000		90 ft		
	7	1,260,000				
	8	1,440,000		41 ft		
	9	1,620,000				
	10	1,800,000				
	11	1,980,000				
	12	2,160,000				
	RU130i (REU-N2024FF-US)	2	260,000	90 ft	150 ft	
3		390,000		100 ft		
4		520,000		65 ft		
5		650,000				
6		780,000				

Common Vent Terminations

Various 3 in., 4 in. and 6 in. Schedule 40 PVC/CPVC Terminations

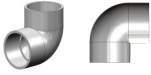
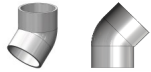
Product Description	Diagram	Horizontal	Vertical	Equivalent Length (ft)
Tee		✓	✓	10
90° Elbow		✓	✓	10
45° Elbow		✓	✓	5

Rinnai Common Vent Terminations (Ubbink C-Vent)

Manufacturer	Phone	Web Site
Ubbink	800-621-9419	www.rinnai.us

Part Number	Product Description	Diagram	Horizontal	Vertical	Equivalent Length (ft)
790096 790095	CVent Roof Termination 6 in. CVent Roof Termination 4in.			✓	5
790125	CVent Roof Termination 3 in.			✓	5
790094 790093 90124	CVent Wall Terminal Kit 6 in. CVent Wall Terminal Kit 6 in. CVent Wall Terminal Kit 6 in.		✓		5
780061 780060	Intake Rain Cap 6 in. Intake Rain Cap 4 in.			✓	N/A
790098 790097	Exhaust Flue Rain Cap 6 in. Exhaust Flue Rain Cap 4 in.			✓	N/A

Schedule 40 PVC/CPVC Common Vent Guidelines

WARNING PVC solvents (primer and glue) can be extremely flammable. Vapors may cause a flash fire or explosion resulting in property damage, personal injury or death.

- Keep solvents away from heat, sparks, flames and all other sources of ignition.
- Do not solder, cut or weld until all vapors have dissipated.
- PVC solvents are heavier than air causing them to settle at low points of the system.
- Before Using PVC solvent
 - Disconnect power to the water heater.
 - Remove the front cover of the water heater.
 - Ensure areas around the water heater and PVC venting are all well ventilated.
 - Allow all vapors to dissipate before applying power to the system or introducing any other source of ignition.

When installing PVC/CPVC Common Vent, follow these guidelines:

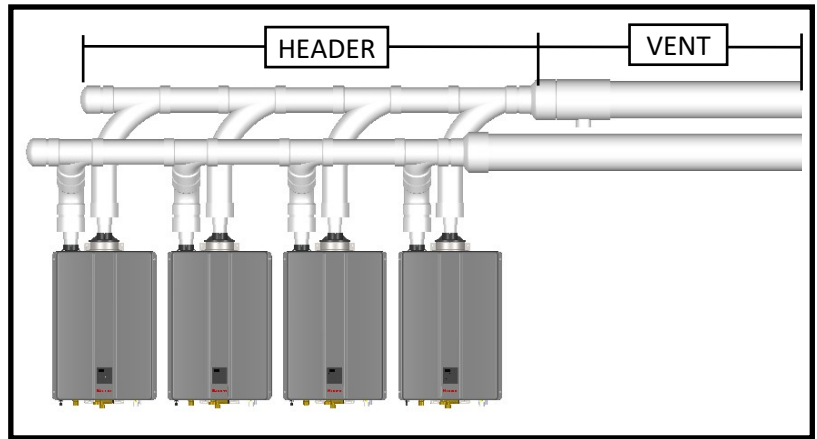

- Avoid sharp bends or tees in the vent system. These vent components create additional restrictions that could reduce performance of the water heaters.
- PVC combustion air and exhaust should terminate with elbow or tee pointing down. This will stop unwanted moisture from entering the vent system.
- Fire rated penetrations shall be firestopped. Contact your vent supplier or local firestop manufacturer for appropriate firestop methods.
- Examine all vent components for damage prior to installation.
- PVC/CPVC vent systems must be free to expand and contract. Refer to the vent manufacturer’s installation instructions for appropriate support methods.
- PVC/CPVC venting must include unrestricted vent movement through walls, ceilings, and roof penetrations.
- Use only PVC/CPVC primer and cement approved for use by the vent manufacturer.
- Refer to vent manufacturer’s installation instructions for proper joint assembly procedures and products.
- PVC/CPVC common venting should include a condensate drain and trap between the header and vent length. Condensate trap must include a loop that can hold 6 in. (15 cm) of water. See “PVC/CPVC Common Vent Installation” illustration on this page.



PVC/CPVC Common Vent Installation

DO NOT

- ✗ DO NOT mix vent pipe, fittings or joining methods from different vent manufacturers.
- ✗ DO NOT attempt to repair damaged vent. Damaged vent components must be replaced.
- ✗ DO NOT use short radius elbows in the common vent system.

ACCEPTABLE	ACCEPTABLE	NOT ACCEPTABLE
90° Elbows, Long Sweep	90° Elbows, Short Sweep	90° Elbows, Close Turn
		

Connecting Multiple Water Heaters (Cascade Communication)

With use of cascade cable(s) up to 24 water heaters can be electronically connected. This connection will rotate water heater operation order to ensure equal usage among the entire system and enables all water heaters connected to modulate operation and function as one hot water source.

NOTE: For proper operation, do not combine different models with cascade communication.

Cascade Cable Required:



- Cable length: 26 ft (8 m)
OR
- Cable Length: 10 ft (3 m)
- One cable required for each water heater.
- Includes 1 cable and 2 cascade jumpers.

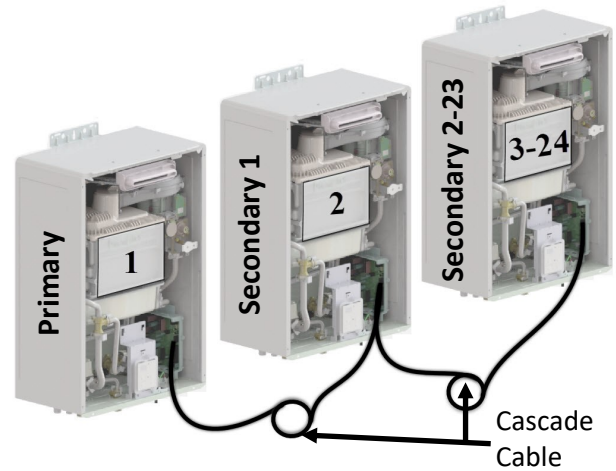

Cascade Cable Assembly

1. Connect one end of the Cascade Cable to the “Cascade OUT” accessory port on the PCB.
2. Connect the other end of the cascade cable to the “Cascade IN” accessory port on the PCB of the next water heater.
3. Repeat steps 1 and 2 for each subsequent water heater in the system.
4. Connect the “Cascade Jumper” (Included with the cascade cable) to the open accessory ports.
5. Proceed to “Programing Cascade Communication” on the following page.

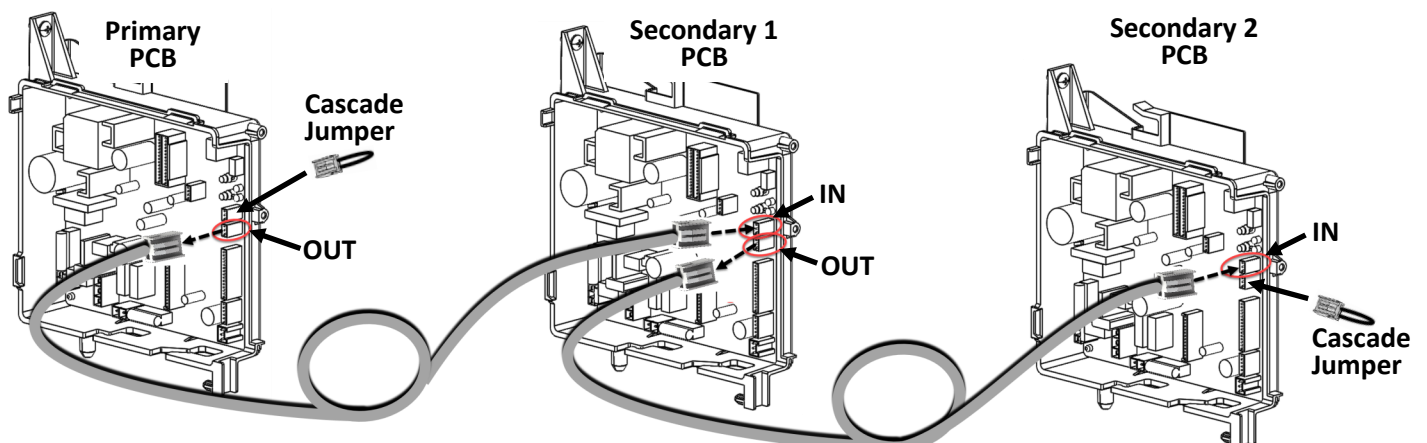
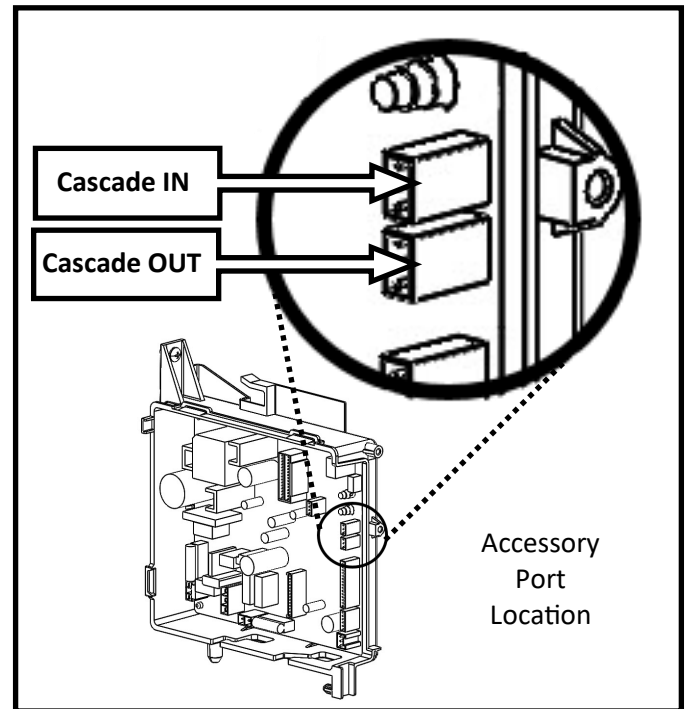

Programming Cascade Communication

Parameter Settings (Cascade Communication)

Refer to the parameter setting section of this manual for instructions on how to access and change parameter settings.

SETTING #	SETTING DESCRIPTION	SELECTION					
		a	b	c	d	e	f
08	Cascade	Secondary (1-23)	Primary				
09	Units in Standby (Cascade)	1	2	3	4	5	6

08 Cascade:

Primary: Select the water heater intended to be the Primary water heater for cascade communication. Set the parameter setting for this water heater to “Primary” (08b).

NOTE: Controller will display the set temperature for the system.

Secondary: Factory Default setting for each water heater is set to “Secondary”. Parameter adjustment is only needed on the water heater identified as “Primary”.

NOTE: Controller will display “- -”.

09 Units in Standby:

Adjust the parameter setting of the primary unit to set the number of water heaters in standby. Standby units will maintain operation with the water flow control valve in the open position. The remaining water heaters will maintain the water flow control valve in the closed position.

Setting Secondary ID

After identifying the “Primary” water heater in the parameter settings, set the Secondary ID for all remaining water heater in the system by pressing the “On/Off” button on the controller.

When ID setting is successful, the controller display will change from “- -” to the newly set ID number.

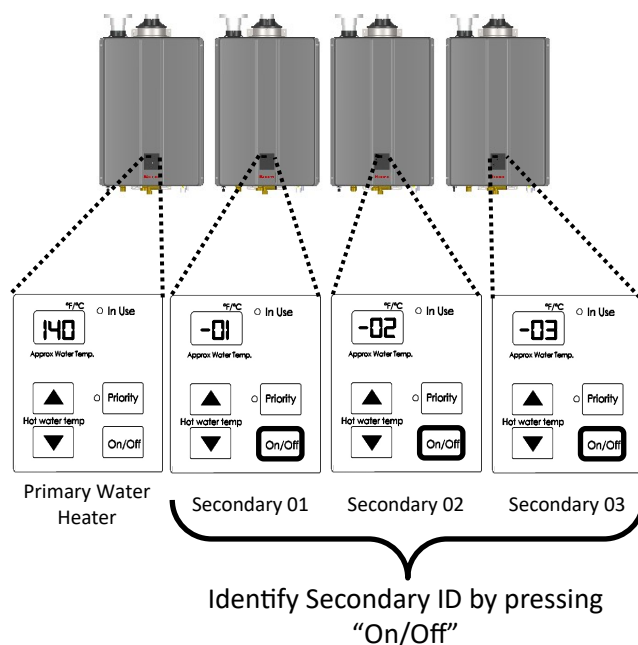

3.6 Connect the Water Supply

Guidelines

- The piping (including soldering materials) and components connected to this appliance must be approved for use in potable water systems.
- Purge the water line to remove all debris and air. Debris will damage the water heater.
- The appliance must not be connected to a system that was previously used with a non-potable water heating appliance.
- Ensure that the water filter on the water heater is clean and installed.
- DO NOT introduce toxic chemicals such as those used for boiler water treatment to the potable water used for space heating.

Instructions

To connect the water supply, follow the instructions below.

IMPORTANT: Water connections to the water heater should follow all state and local plumbing codes.

If this is a standard installation, refer to the “Piping Diagram for Basic Installation” below.

1. Plumb the cold water supply line to the water heater on the 3/4 in. MNPT connection at the bottom of the water heater marked “COLD.”
2. Plumb the hot water supply line to the 3/4 in. MNPT connection marked “HOT.”
3. If a pipe cover will be installed, make sure water lines to the water heater fit within the confinements of the pipe cover.

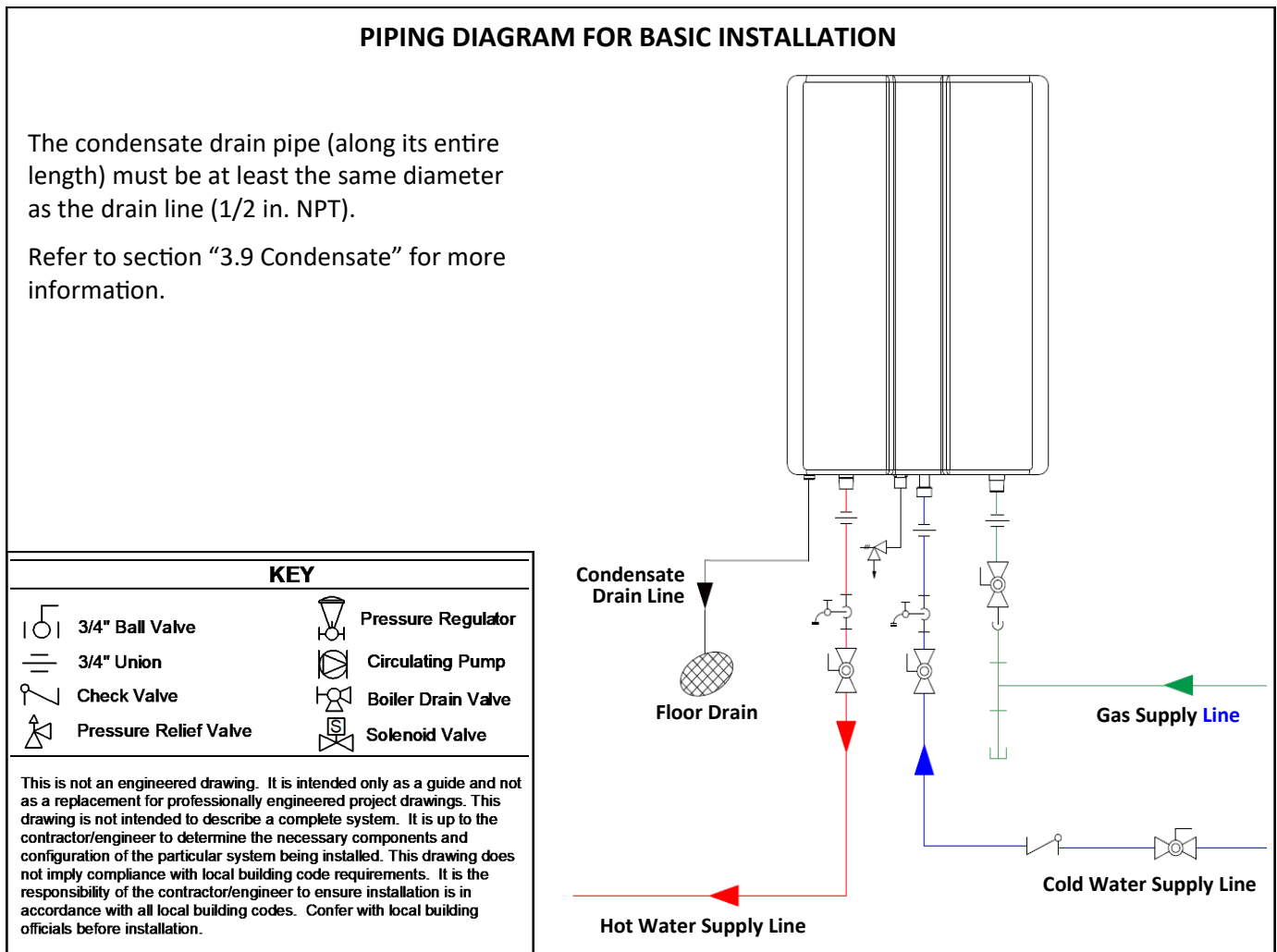

3.7 Install the Isolation Valves

Isolation valves (included with water heater) provide the ability to isolate the water heater from the structure's plumbing and allow quick and easy access to flush the heat exchanger. The supplied isolation valves meet *American National Standard (ANSI Z21.10.3) / Canadian Standard (CSA 4.3)* and are ANSI/NSF 61 approved for potable water.

To install isolation valves:

1. Apply thread sealant to the exposed threads of the **Cold Inlet** and **Hot Outlet** of the water heater.
2. Hand tighten the **Union Fitting** to the **Cold Inlet** and **Hot Outlet** of the water heater.
3. With a wrench, tighten the **Union Fittings**. Do not tight more than two turns past hand tight.
4. Position the **Hot Isolation Valve (Red)** and **Gasket** below the **Union Fitting** on the **Hot Outlet** side of the water heater.
5. Hand tighten the **Union Nut** of the **Hot Isolation Valve (Red)** to the **Union Fitting**.
6. Rotate the **Drain Valve** to an accessible position. With a wrench, tighten the **Union Nut** to the **Union Fitting**.
7. Repeat steps 4 - 6 for the **Cold Isolation Valve (Blue)**.
8. Connect the **Cold Isolation Valve (Blue)** to the **Cold Water Supply Line**.
9. Connect the **Hot Isolation Valve (Red)** to the **Hot Water Supply Line**.
10. Ensure that both **Drain Valves** are in the closed position before turning on water supply.

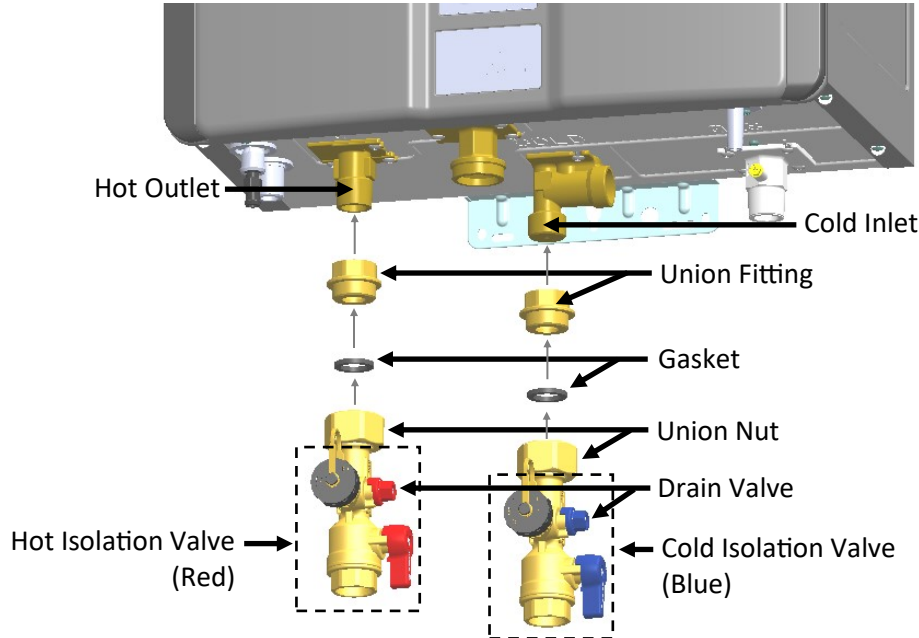

NOTICE:

DO NOT use pipe dope or thread sealant on union fitting with gasket.

NOTICE:

When unscrewing the union fitting, be careful not to lose the gasket.

3.8 Pressure Relief Valve



WARNING

Water discharged from the pressure relief valve could cause severe burns instantly or death from scalds.

Guidelines

An approved pressure relief valve is required by the *American National Standard (ANSI Z21.10.3)* for all water heating systems and shall be accessible for servicing. When connecting a pressure relief valve, follow the guidelines below:

- The pressure relief valve must comply with the standard for *Relief Valves and Automatic Gas Shutoff Devices for Hot Water Supply Systems ANSI Z21.22* and /or the standard *Temperature, Pressure, Temperature and Pressure Relief Valves and Vacuum Relief Valves, CAN1-4.4*.
 - The pressure relief valve must be rated up to 150 psi and to at least the maximum Btu/hr of the appliance.
 - The discharge from the pressure relief valve should be piped to the ground or into a drain system per local codes.
 - The pressure relief valve must be manually operated once a year to check for correct operation.
 - The discharge line from the pressure relief valve should pitch downward and terminate 6 in. (152 mm) above drains where discharge will be clearly visible.
 - The discharge end of the line shall be plain (unthreaded) and a minimum of 3/4 in. nominal pipe diameter. The discharge line material must be suitable for water at least 180° Fahrenheit.
 - The pressure relief valve is assembled to the pressure relief valve adapter as illustrated on the next page. **DO NOT** place any other valve or shut off device between the pressure relief valve and the water heater.
 - If a pressure relief valve discharges periodically, this may be due to thermal expansion in a closed water supply system. Contact the water supplier or local plumbing inspector on how to correct this situation. Do not plug the pressure relief valve.
 - The *American National Standard (ANSI Z21.10.3)* does not require a combination temperature and pressure relief valve for this appliance. However, local codes may require a combination temperature and pressure relief valve.
 - Protect pressure relief valve and pressure relief valve discharge line from freezing. Do not plug or restrict flow of the pressure relief valve.
-
- ❌ **DO NOT** plumb the pressure relief valve with the condensate drain; both must be plumbed independently to drain.
 - ❌ **DO NOT** plug the pressure relief valve and do not install any reducing fittings or other restrictions in the relief line. The pressure relief line should allow for complete drainage of the valve and the line.
 - ❌ **DO NOT** place any other valve or shutoff device between the pressure relief valve and the water heater.

Pressure Relief Valve Installation Instructions

To install the pressure relief valve, follow the steps below.

1. On the bottom of the tankless water heater, hand tighten the **Pressure Relief Valve Assembly** and **Gasket** to the **Pressure Relief Valve Union Fitting**.
2. Rotate the **Pressure Relief Valve Assembly** to the desired accessible position. With a wrench, tighten the **Union Nut** to the **Pressure Relief Valve Union Fitting**.

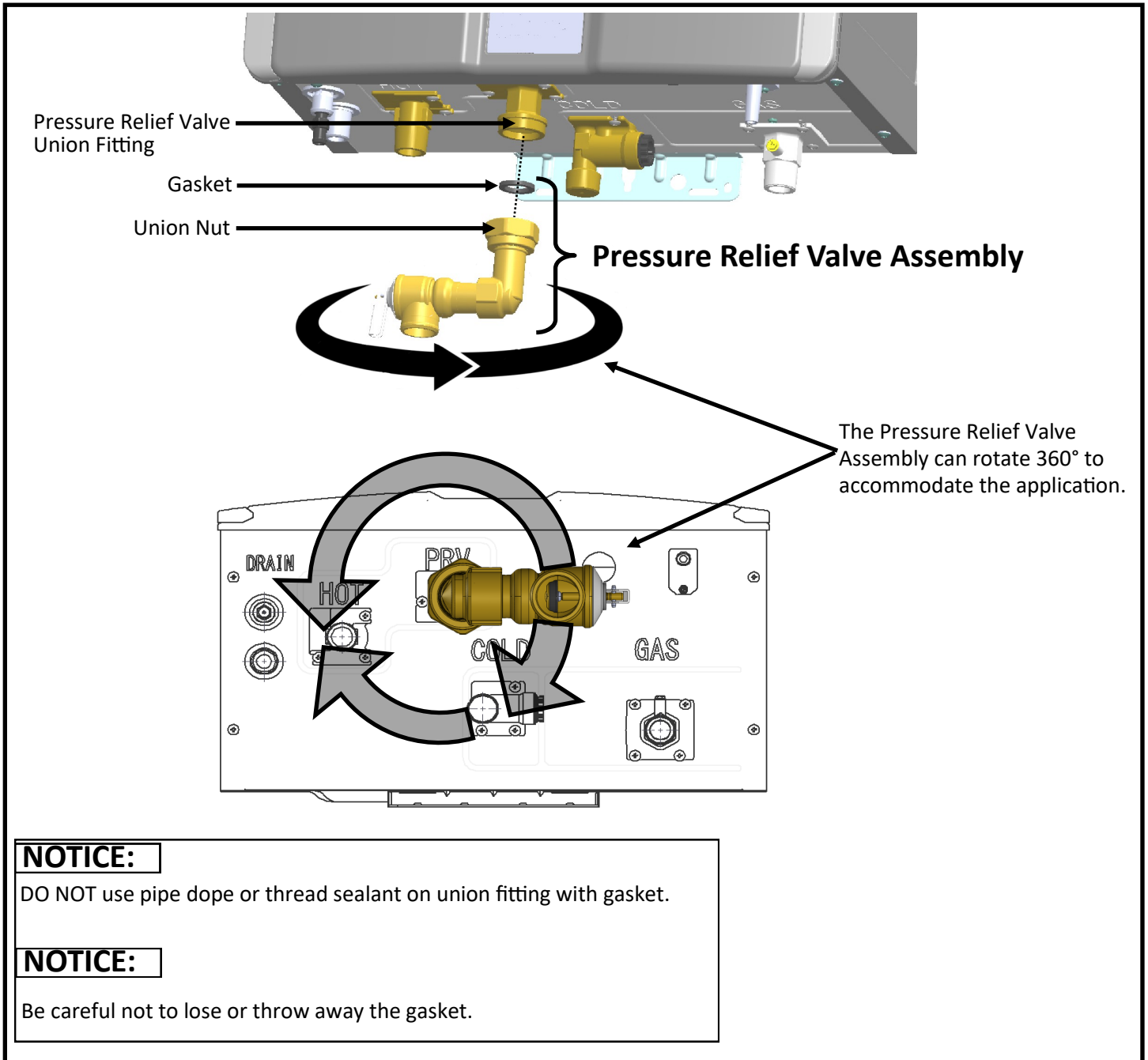

3.9 Condensate

Condensate Guidelines

To prevent condensate damage, follow these guidelines:

- Do not plumb the condensate drain with the pressure relief valve; both must be plumbed independently to drain.
- All condensate must drain and be disposed of according to local codes.
- Use only corrosion resistant materials for the condensate drain lines such as PVC pipe or plastic hose.
- The condensate drain pipe (along its entire length) must be at least the same diameter as the drain line (1/2 in. MNPT).
- Condensation drain lines installed in areas that are subject to freezing temperatures should be wrapped with an approved supplemental heat source. Install per manufacturer's instructions.
- Slope the condensate drain lines toward the inside floor drain or condensate pump.
- For external (outdoor) installations, to minimize freezing of the condensate, run the condensate drain line through an interior wall or between insulation and an interior wall.
- If a floor drain is not available or the drain is above the level of the condensate drain, a condensate pump should be installed.
- A condensate neutralizer kit is available from Rinnai. The kit allows condensate to flow through neutralizing media that raises the pH of the condensate to a level that will help prevent corrosion of the drain and public sewer system. Refer to section "2.4 Accessories" for more information.
- The condensate drain pipe should be as short as possible and have a downward pitch.
- The condensate trap will automatically prime (self-prime) during operation of the water heater as condensate forms. Condensate draining from the water heater indicates that the trap is full and that there is no blockage in the condensate drain. It is not necessary to add water to the condensate trap.

- The end of the condensate drain pipe should be open to the atmosphere. The end should not be under water or other substances.



CORRECT

Pipe open to atmosphere

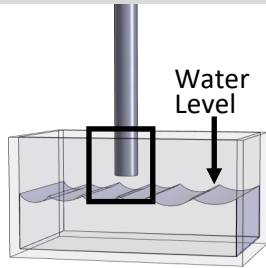

NOT CORRECT

Pipe submerged in water

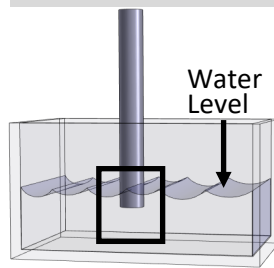

DO NOT

- **DO NOT connect the condensate drain line with an air conditioning evaporator coil drain.**
- **Water heaters have an integrated condensate trap. DO NOT install an external condensate trap.**



EXTERNAL TRAP NOT REQUIRED

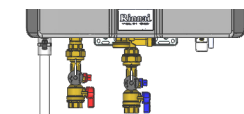

Pipe open to atmosphere

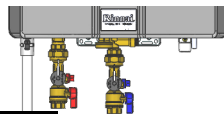

Neutralizer

Refer to neutralizer Installation Manual and local codes for neutralizer installation guidelines.

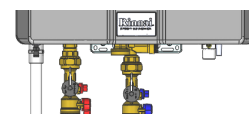

Condensate Pump

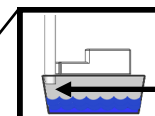

Pipe open to atmosphere

Condensate Drain Pipe Connection

To connect the condensate drain pipe:

1. Apply thread sealant to 1/2 in. MNPT condensate drain port.
2. Thread 1/2 in. NPT fitting onto condensate drain port.
3. Follow the steps in the next section: "Condensate Pump Safety Switch Wiring."

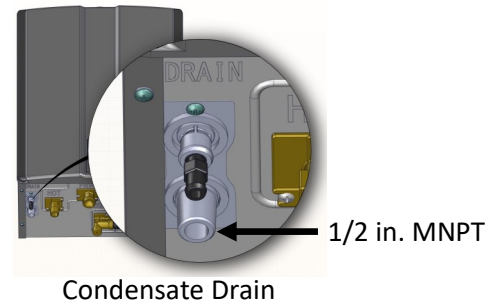

Condensate Pump Safety Switch Wiring

IMPORTANT: The steps in this section must conform with local codes and the guidelines established by the National Electrical Code (NEC).

The condensate pump (if installed) should be wired to deactivate the water heater in the event the condensate pump fails.

1. Disconnect power from the water heater.
2. Open the water heater cover and locate two white wires labeled "To Condensate Pump Safety Switch."
3. Cut crimp connectors off white wires and strip the insulation off of the two ends.
4. Select an appropriate length of wire (18 AWG or greater) and strip the insulation off the ends. Follow the wiring guidelines established by the National Electrical Code (NEC).

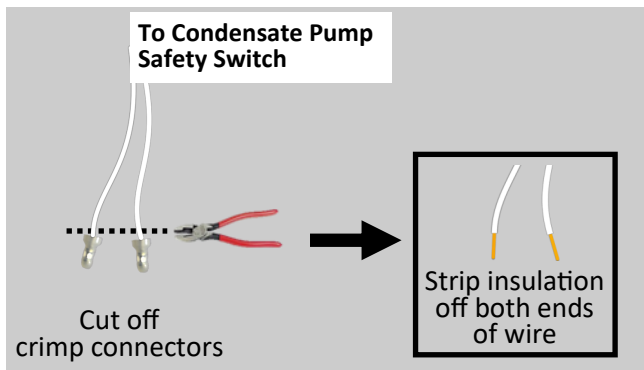

5. With wire nuts or other approved wire connectors, connect the "To Condensate Pump Safety Switch" wires to the normally open contacts on the condensate pump (see image below).
6. Reconnect power to the water heater and press the "On/Off" button on the controller.

Test Operation

1. Test the operation of the shut off switch by unplugging the condensate pump and filling the condensate reservoir with water until the float switch closes the circuit.
2. Turn on the water heater.
3. The water heater displays diagnostic code "25."
4. Plug in the condensate pump in and confirm condensate is flowing out of the reservoir.
5. Turn off the water heater by pressing the "On/Off" button on the controller. Wait five seconds then turn the power back on. This will clear the diagnostic code.

Condensate Pump Safety Switch Installation

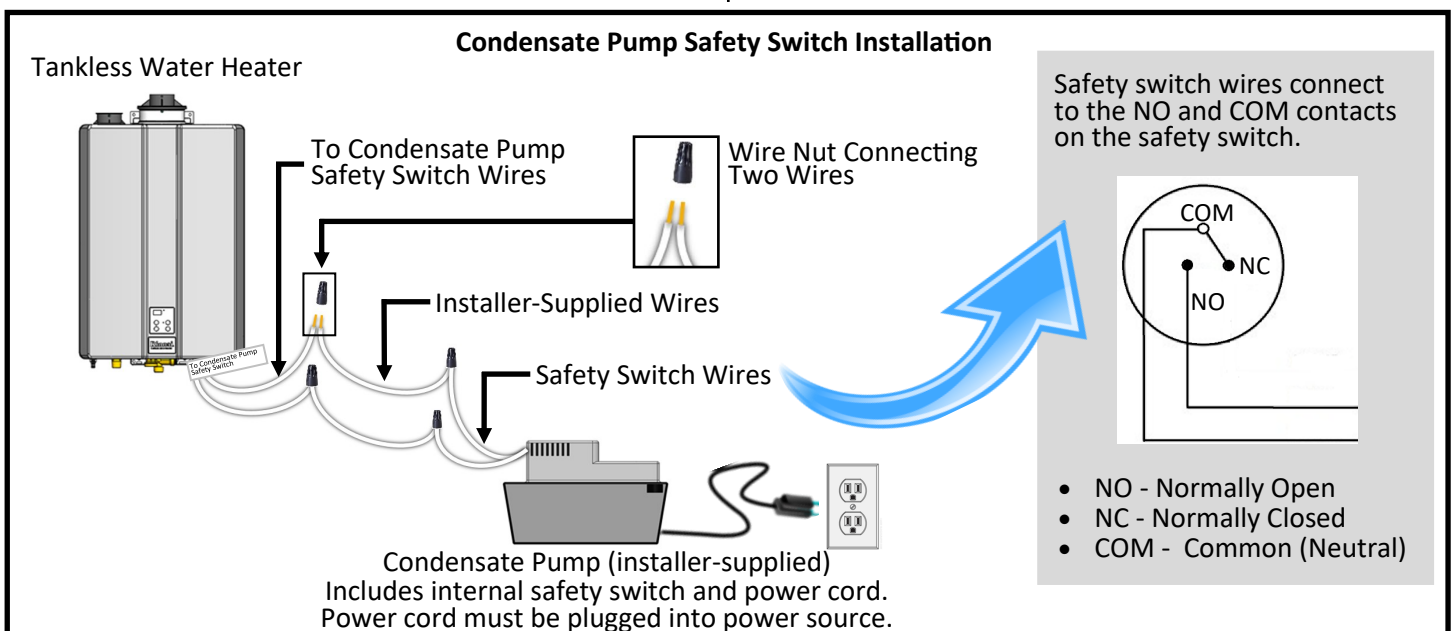

3.10 Connect the Gas Supply

WARNING

- A licensed professional must install the gas supply.
- Turn off 120V power supply.
- Turn off the gas.
- Gas is flammable. Do not smoke or provide other ignition sources while working with gas.
- Do not turn on the water heater or gas until all fumes are gone.

Instructions

To connect the gas supply, follow the instructions below:

1. Install a manual gas control valve in the gas supply line to the water heater. A union can be used on the connection above the shut off valve for the future servicing or disconnection of the water heater.
2. Check the type of gas and gas supply pressure before connecting the water heater. If the water heater is not of the gas type that the building is supplied with, DO NOT connect the water heater. Contact the dealer for the proper water heater to match the gas type.
3. Check the gas supply pressure immediately upstream at a location provided by the gas company. Supplied gas pressure must be within the limits shown in section “2.5 Specifications” with all gas appliances operating.
4. Before placing the appliance in operation, all joints including the heater must be checked for gas tightness by means of soap, gas leak detector solution, or an equivalent nonflammable solution, as applicable. (Since some leak test solutions, including soap and water, may cause corrosion or stress cracking, the piping shall be rinsed with water after testing, unless it has been determined that the leak test solution is non-corrosive.)
5. Use approved connectors to connect the water heater to the gas line. Purge the gas line of any debris before connection to the water heater.
6. Any compound used on the threaded joint of the gas piping shall be a type that resists the action of liquefied petroleum gas (propane/LPG).
7. The gas supply line shall be gas tight, sized, and so installed as to provide a supply of gas sufficient to meet the maximum demand of the heater and all other gas consuming appliances at the location without loss of pressure. If in doubt about the size of the gas line, refer to the “Gas Pipe Sizing Reference Tables” section on the next page.
8. Perform a leak and pressure test prior to operating the water heater. If a leak is detected, do not operate the water heater until the leak is repaired.

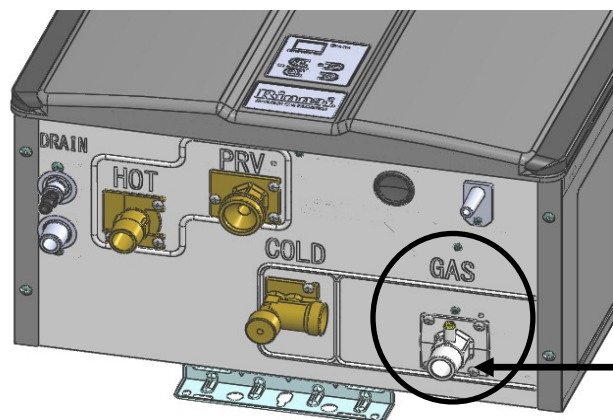

Gas connection 3/4 in.
MNPT connection

Gas Pipe Sizing Reference Tables

The gas supply must be capable of handling the entire gas load required at the location. Gas line sizing is based on gas type, the pressure drop in the system, the gas pressure supplied, and gas line type. For gas pipe sizing, refer to the National Fuel Gas Code, ANSI Z223.1/NFPA 54, or the Natural Gas and Propane Installation Code, CSA B149.1

For some tables, you will need to determine the cubic feet per hour of gas required by dividing the gas input by the heating value of the gas (available from the local gas company). The gas input needs to include all gas products at the location and the maximum Btu usage at full load when all gas products are in use.

Use the table for your gas type and pipe type to find the pipe size required. The pipe size must be able to provide the required cubic feet per hour of gas or the required Btu/hour.

The information below is provided as an example. The appropriate table from the applicable code must be used.

GAS PIPE SIZING CALCULATION WORKSHEET

Instructions: Enter values in empty boxes.

Rinnai Model Gas Input:
A Btu/hr

Additional Appliance Total Gas Input:
B Btu/hr

Heating Value of Gas:
C Btu/ft³

Cubic Feet Per Hour (CFH):

$$(CFH) = \frac{A + B}{C}$$

(CFH) =

ANSWER: CFH = ft³/hr

Natural Gas

Pressure Drop 0.5 in. w.c.				
<i>Information in table obtained from NFPA 54, ANSI Z223.1 - 2015.</i>	Schedule 40 Metallic Pipe			
	Inlet Pressure:		Less than 2 psi	
	Specific Gravity:		0.60	
	Nominal Pipe Size (in.)			
	1/2	3/4	1	1 1/4
Length in ft (meters)	Capacity in Cubic Feet of Gas per Hour			
10 (3)	172	360	678	1,390
20 (6)	118	247	466	957
30 (9)	95	199	374	768
40 (12)	81	170	320	657
50 (15)	72	151	284	583
60 (18)	65	137	257	528
70 (21)	60	126	237	486
80 (24)	56	117	220	452
90 (27)	52	110	207	424
100 (30)	50	104	195	400

EXAMPLE

Rinnai Model Gas Input:
A 199,000 Btu/hr

Additional Appliance Total Gas Input:
B 65,000 Btu/hr

Heating Value of Gas:
C 1,000 Btu/ft³

Cubic Feet Per Hour (CFH):

$$(CFH) = \frac{A + B}{C}$$

$\frac{199,000 + 65,000}{1000}$

(CFH) = 264

ANSWER: CFH = 264 ft³/hr

For this example, the pipe diameter must be at least 3/4 in. pipe size and 10 ft (3 m) in length.

Natural Gas

Pressure Drop 3.0 in. w.c.

Intended use: Initial supply pressure of 8.0 in. w.c. or greater.

Information in table obtained from NFPA 54, ANSI Z223.1 - 2015.

Schedule 40 Metallic Pipe	
Inlet Pressure:	Less than 2 psi
Specific Gravity:	0.6

Length in ft (meters)	Nominal Pipe Size (in.)			
	1/2	3/4	1	1 1/4
	Capacity in Cubic Feet of Gas per Hour			
10 (3)	454	949	1,790	3,670
20 (6)	312	652	1,230	2,520
30 (9)	250	524	986	2,030
40 (12)	214	448	844	1,730
50 (15)	190	397	748	1,540
60 (18)	172	360	678	1,390
70 (21)	158	331	624	1,280
80 (24)	147	308	580	1,190
90 (27)	138	289	544	1,120
100 (30)	131	273	514	1,060

EXAMPLE

Rinnai Model Gas Input:

$$A \quad 199,000 \quad \text{Btu/hr}$$

Additional Appliance total Gas Input:

$$B \quad 65,000 \quad \text{Btu/hr}$$

Heating Value of Gas:

$$C \quad 1,000 \quad \text{Btu/ft}^3$$

Cubic Feet Per Hour (CFH):

$$(\text{CFH}) = \frac{A + B}{C}$$

$$(\text{CFH}) = \frac{199,000 + 65,000}{1000}$$

ANSWER:

$$\text{CFH} = 264 \quad \text{ft}^3/\text{hr}$$

For this example, the pipe diameter must be at least 1/2 in. nominal pipe size and 20 ft (6 m) in length.

Propane (Undiluted)

Pressure Drop 0.5 in. w.c.

Information in table obtained from NFPA 54, ANSI Z223.1 - 2015.

Schedule 40 Metallic Pipe	
Inlet Pressure:	11 in. w.c.
Specific Gravity:	1.50

Length in ft (meters)	Nominal Inside Pipe Size (in.)			
	1/2	3/4	1	1 1/4
	Capacity in Thousands of Btu per Hour			
10 (3)	291	608	1,150	2,350
20 (6)	200	418	787	1,620
30 (9)	160	336	632	1,300
40 (12)	137	287	541	1,110
50 (15)	122	255	480	985
60 (18)	110	231	434	892
80 (24)	101	212	400	821
100 (30)	94	197	372	763

EXAMPLE

Rinnai Model Gas Input:

$$A \quad 199,000 \quad \text{Btu/hr}$$

Additional Appliance Total Gas Input:

$$B \quad 65,000 \quad \text{Btu/hr}$$

Total Gas Input:

$$\text{Total Gas Input} = A + B$$

$$\text{Total Gas Input} = 199,000 + 65,000$$

ANSWER:

$$\text{Total Gas Input} = 264,000 \quad \text{Btu/hr}$$

For this example, the pipe diameter must be at least 1/2 in. nominal pipe size and 10 ft (3 m) in length.

3.11 Connect the Power Supply

WARNING

- Do not use an extension cord or adapter plug with this appliance.
- The water heater must be electrically grounded in accordance with local codes and ordinances or, in the absence of local codes, in accordance with the National Electrical Code, ANSI/NFPA No. 70.
- Indoor water heaters are equipped with a three-prong (grounding) plug for your protection against shock hazard and should be plugged directly into a properly grounded three-prong receptacle. Do not cut or remove the grounding terminal from this plug.

Guidelines

When connecting the power supply, follow these guidelines:

- Do not rely on the gas or water piping to ground the water heater. Ground locations are provided inside the water heater.
- The water heater requires 120 VAC, 60 Hz power from a properly grounded circuit.
- If using the 5 ft (1.5 m) power cord (supplied with internal/indoor water heaters), plug it into a standard 3 prong 120 VAC, 60 Hz properly grounded wall outlet.
- On external (outdoor) models, a disconnect switch must be provided and installed for the incoming 120 VAC power. The switch should be a type that is suitable for outdoor use. Check the National Electrical Code, ANSI/NFPA 70 and your local codes for a proper switch type to use in your area. Power connections must be protected from the weather and flexible cords must use an appropriate strain relief.
- The wiring diagram is located on the inside of the water heater front cover.

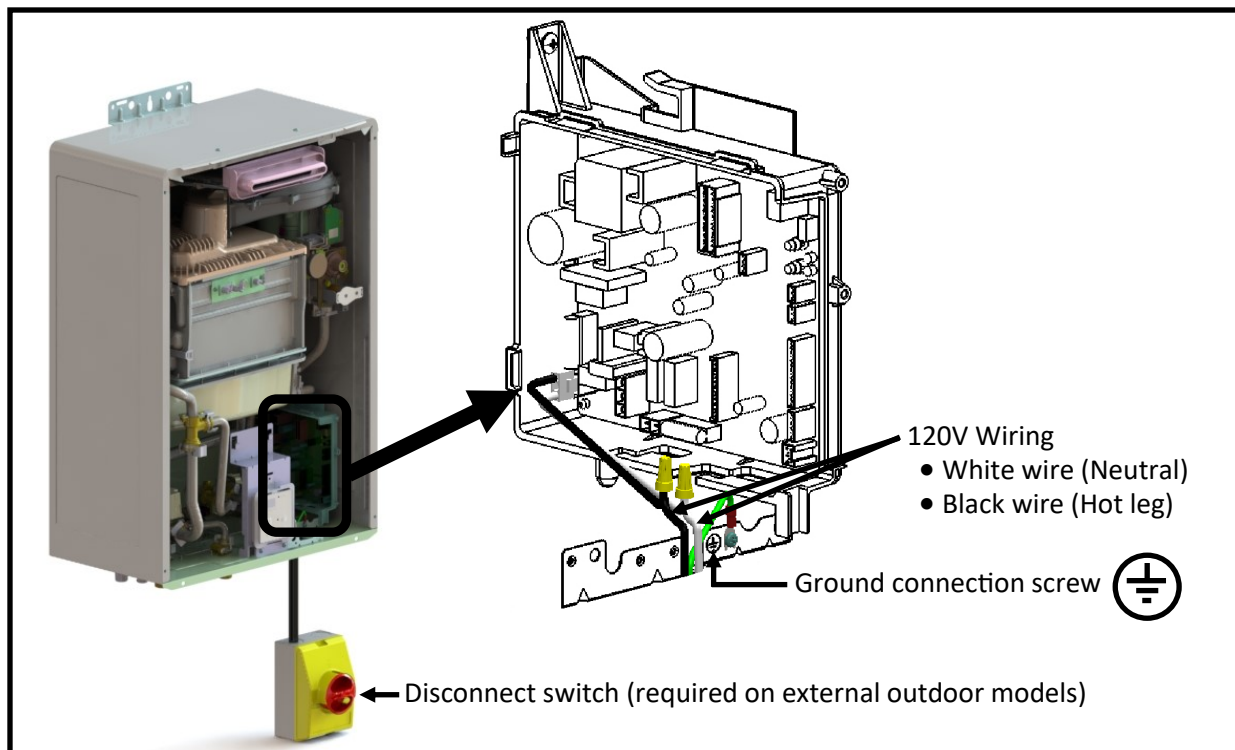

Post-Power Supply Connection Checklist

- Confirm that the electricity is supplied from 120 VAC, 60 Hz power source and is in a properly grounded circuit.
- Confirm that an extension cord or an adapter plug has **NOT** been used with the water heater.

3.12 Parameter Settings

WARNING DO NOT adjust parameter settings unless specifically instructed to do so.

Certain elements of the installation may require adjusting the parameters of the tankless water heater.

To adjust the parameters:

1. Locate the PC Board (lower right side of unit).
2. Locate the two push buttons (A and B) on the PC Board.
3. Press the “A” button for 1 second.

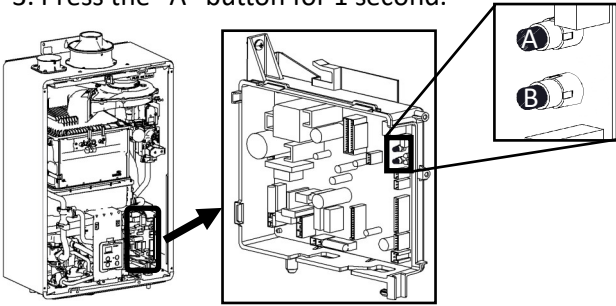

Parameter Settings Table

Default is **A** for all settings below except **i0**, **i2**, **i3**, and **i4** which are factory set.

SETTING #	SETTING DESCRIPTION	SELECTION					
		A	b	C	d	E	F
01	Maximum Set Temperature	140° F	185° F				
02	High Altitude (Installation Location)	0 - 2,000 ft (0 - 610 m)	2,001 - 5,400 ft (610 - 1,585 m)	5,401 - 7,700 ft (1,585 - 2,347 m)	7,701 - 10,200 ft (2,347 - 3,109 m)		
03	Service Soon ¹	Disabled	0.5 Year	1 Year	2 Years		
04	Recirculation Settings	No Recirculation	Recirculation (Dedicated)				
05	Recirculation Mode ²	Economy	Comfort				
06	Control Switch	BMS ³	Air Handler (AH)				
07	Units in Standby (EZ Connect)	2	1				
08	Cascade	Secondary	Primary				
09	Units in Standby (Cascade) ⁴	1	2	3	4	5	6
i0	Gas Type (Factory Set)	NG	LPG				
i1	Maximum Flow Rate ⁵	Standard	High				
i2	Water Heater Model (Factory set values and not adjustable)	Commercial without Pump (CU)					
i3		CU199 (REU-N3237)		CU160 (REU-N2530)			
i4		Internal (Indoor)	External (Outdoor)				

¹ See section “3.13 Service Indicator (Service Soon, 55)” for more information.

² Setting **05** is available only if setting **04 b** is selected.

Economy mode cycles the pump less often, using less energy to maintain the circulation loop temperature.

Comfort mode cycles the pump more frequently, ensuring the loop temperature remains higher (but also uses more energy).

³ BMS = Building Management System

⁴ Setting **09** is available only if setting **08 b** is selected.

⁵ Selecting “High” will increase the water flow rate to the maximum capacity.

4. Use the ▲ (Up) and ▼ (Down) buttons on the controller to select a setting number (see Parameter Settings Table below).

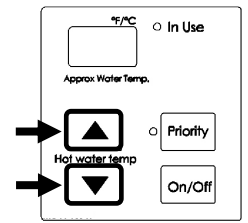

5. Once the desired setting number is selected, use the “On/Off” button on the controller to change the selection for the setting number.

Example: Display will change from 01A to 01b for Maximum Temperature setting (as shown below).

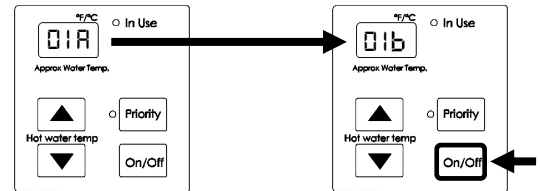

6. To exit the parameters, press the “A” button for 1 second.

3.13 External Pump with Circ-Logic

Rinnai SENSEI™ Tankless Water Heaters include Circ-Logic technology that offers the comfort and convenience of instant hot water with the use of an external recirculation pump. Circ-Logic controls the on/off sequence and operation cycles of the external recirculation pump through the programming of the tankless water heater’s parameter settings. In commercial settings, the external pump cable is included with the tankless water heater. Circ-Logic operates in either Economy or Comfort mode based on the parameter settings of the water heater.

- **Economy Mode**—Cycles the pump less often, using less energy to maintain the circulation loop temperature.
- **Comfort Mode**—Cycles the pump more frequently, ensuring the loop temperature remains higher (but also uses more energy).

	Rinnai Set Temperature												
	140	135	130	125	120	115	110	108	106	104	102	100	98
	Typical Pump OFF Intervals (Minutes)												
Economy	18	20	22	24	28	32	38	40	44	48	52	56	62
Comfort	9	10	11	12	14	16	19	20	22	24	26	28	31

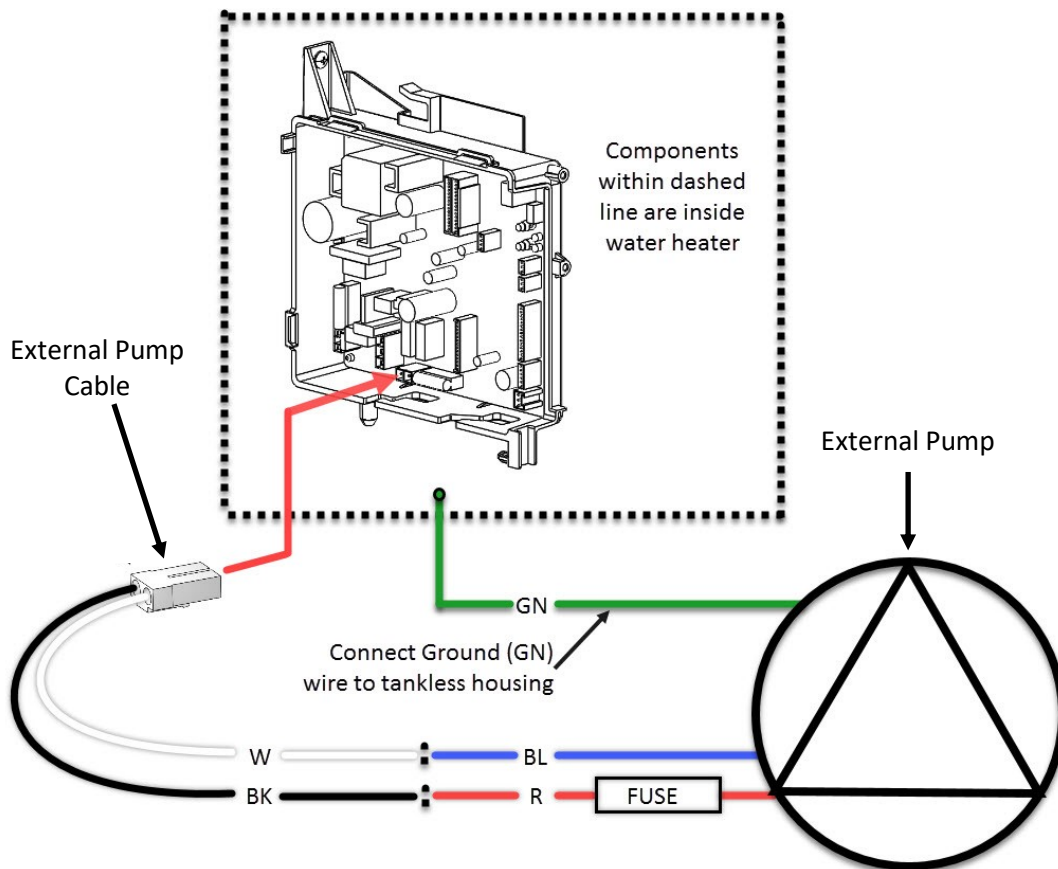

3.14 Service Indicator (Service Soon, 55)

This water heater includes a service indicator (Service Soon, 55). When selected in the parameter settings, an 55 code will display on the controller indicating that it is time to flush and service the water heater.

- Selection is installers preference based on water conditions or other factors that may influence the suggested interval of service.
- See the parameter settings section of this manual for selectable service intervals.
- If Service Soon (55) appears on the controller displayed contact you local service provider to flush and service the water heater. (see 5.3 Flushing the Heat Exchanger)
- Service Soon will appear again when the time reach to the interval by setting from reset.

To reset Service Soon(55)
Press the ON/OFF button 5 times

NOTE: Service Soon (55) will display on the controller again when the water heater reaches the interval selected in the parameter settings.

3.15 Post-Water Heater Installation Checklist

Complete the following checklist when water heater installation is complete. You should be able to answer YES to each question. If you answer NO to any question, installation is not complete. Refer to the applicable section in the Rinnai Tankless Water Heater Installation and Operation Manual for additional information.

For assistance, contact your local dealer or distributor, or call Rinnai Customer Care at 1-800-621-9419.

Reference the Rinnai Tankless Water Heater Installation and Operation Manual For Additional Information on the Items Below		
1	INSTALLATION LOCATION	YES NO
	Have you verified the unit, vent and air intakes meet the clearance requirements?	<input type="checkbox"/> <input type="checkbox"/>
2	COMBUSTION AIR & VENTING	YES NO
	Have all corrosive compounds been removed from around the combustion air inlet of the tankless water heater?	<input type="checkbox"/> <input type="checkbox"/>
	Have you followed the combustion air requirements to provide sufficient combustion air for the tankless water heater?	<input type="checkbox"/> <input type="checkbox"/>
	Are the correct venting products for the installed model being utilized?	<input type="checkbox"/> <input type="checkbox"/>
	Have you installed the vent screen(s) for PVC vent applications?	<input type="checkbox"/> <input type="checkbox"/>
	Have you verified the vent system does not exceed maximum length?	<input type="checkbox"/> <input type="checkbox"/>
3	PLUMBING	YES NO
	Have the water lines been purged of all debris and the filter cleaned?	<input type="checkbox"/> <input type="checkbox"/>
	Have you verified the hot and cold water lines to the tankless water heater are not interchanged?	<input type="checkbox"/> <input type="checkbox"/>
	Does the water supply to the heater have adequate pressure? Is it free of chemicals? Did you verify it does not exceed total hardness that will damage the heat exchanger?	<input type="checkbox"/> <input type="checkbox"/>
	Have you verified that no toxic chemicals were introduced to the potable water?	<input type="checkbox"/> <input type="checkbox"/>
	Did you drain the tankless water heater if not intended to be used immediately?	<input type="checkbox"/> <input type="checkbox"/>
	Have water quality issues (if any) been addressed?	<input type="checkbox"/> <input type="checkbox"/>
	Have you performed the leak and pressure test for the tankless water heater and plumbing system?	<input type="checkbox"/> <input type="checkbox"/>
4	ISOLATION VALVES	YES NO
	Are the isolation valves (included with the tankless water heater) installed?	<input type="checkbox"/> <input type="checkbox"/>

3.14 Post-Water Heater Installation Checklist Continued

5 PRESSURE RELIEF VALVE (PRV)		YES	NO
Does the PRV comply with the standard for <i>Relief Valves and Automatic Gas Shutoff Devices for Hot Water Supply Systems ANSI Z21.22</i> , and/or the standard <i>Temperature, Pressure, Temperature and Pressure Relief Valves and Vacuum Relief Valves, CAN1-4.4</i> ?	<input type="checkbox"/>	<input type="checkbox"/>	
Did you verify the PRV is rated up to 150 psi and (at least) the maximum Btu/hr of the tankless water heater?	<input type="checkbox"/>	<input type="checkbox"/>	
Is the discharge from the PRV piped to the ground or into a drain system as per local codes?	<input type="checkbox"/>	<input type="checkbox"/>	
Is the discharge line from the PRV pitched downward and does it terminate 6 in. (152 mm) above the drains?	<input type="checkbox"/>	<input type="checkbox"/>	
Is the discharge end of the line plain (unthreaded) and a minimum of 3/4 in. diameter?	<input type="checkbox"/>	<input type="checkbox"/>	
Is the discharge line material suitable for at least 180° F water?	<input type="checkbox"/>	<input type="checkbox"/>	
Did you take measures to protect the PRV and PRV discharge line from freezing?	<input type="checkbox"/>	<input type="checkbox"/>	
Have you verified the PRV is not plumbed with the condensate drain line?	<input type="checkbox"/>	<input type="checkbox"/>	
Have you verified the PRV is not plugged and that reducing fittings, valves, or other restrictions are not installed in the relief line?	<input type="checkbox"/>	<input type="checkbox"/>	
6 CONDENSATE DRAIN		YES	NO
If the condensate pump is installed, is it wired to deactivate the tankless water heater in the event of failure? For more information, refer to the “Condensate Pump Safety Switch Wiring” section of the manual.	<input type="checkbox"/>	<input type="checkbox"/>	
Did you verify the condensate drain pipe is as short as possible and has a downward pitch toward the drain or condensate pump?	<input type="checkbox"/>	<input type="checkbox"/>	
Is all condensate drained and disposed of as per local codes?	<input type="checkbox"/>	<input type="checkbox"/>	
Did you use ONLY corrosion resistant materials for the condensate drain lines?	<input type="checkbox"/>	<input type="checkbox"/>	
Did you verify the condensate drain pipe along its entire length is at least the same diameter as the drain line (1/2 in. NPT)?	<input type="checkbox"/>	<input type="checkbox"/>	
Did you check to ensure the condensation drain lines are protected from freezing?	<input type="checkbox"/>	<input type="checkbox"/>	
If a floor pump is not available or the drain is above the level of the condensate drain, did you install a condensate pump?	<input type="checkbox"/>	<input type="checkbox"/>	
Have you verified the condensate drain line is not plumbed with the pressure relief valve?	<input type="checkbox"/>	<input type="checkbox"/>	
Have you confirmed the condensate drain line is not connected with an air conditioning evaporator coil drain?	<input type="checkbox"/>	<input type="checkbox"/>	
Have you verified an external condensate trap is not installed? (This tankless water heater has an integrated condensate trap.)	<input type="checkbox"/>	<input type="checkbox"/>	
Have you confirmed the end of the condensate drain pipe is open to atmosphere?	<input type="checkbox"/>	<input type="checkbox"/>	
7 GAS SUPPLY		YES	NO
Did you verify the gas system is appropriately sized?	<input type="checkbox"/>	<input type="checkbox"/>	
Did you verify the water heater is rated for the gas type supplied?	<input type="checkbox"/>	<input type="checkbox"/>	
Have you performed a gas line and connection leak test?	<input type="checkbox"/>	<input type="checkbox"/>	
Did you install a manual gas control valve in the gas line to the water heater?	<input type="checkbox"/>	<input type="checkbox"/>	
Is the inlet gas pressure within limits?	<input type="checkbox"/>	<input type="checkbox"/>	
Did you purge the gas line of any debris before connecting the water heater?	<input type="checkbox"/>	<input type="checkbox"/>	

4. Operate the Water Heater

4.1 Safety Precautions

⚠ WARNING If the information in these instructions is not followed exactly, a fire or explosion may result causing property damage, personal injury, or death.

- Do not store or use gasoline or other flammable vapors and liquids in the vicinity of this or any other appliance.
- Before operating, smell all around the appliance area for gas. Be sure to smell next to the floor because some gas is heavier than air and will settle on the floor.
- WHAT TO DO IF YOU SMELL GAS
 - Do not try to light any appliance.
 - Do not touch any electrical switch; do not use any phone in your building.
 - Immediately call your gas supplier from a neighbor's phone. Follow the gas supplier's instructions.
 - If you cannot reach your gas supplier, call the fire department.
- Installation and service must be performed by a qualified installer, service agency or the gas supplier.

⚠ AVERTISSEMENT Assurez-vous de bien suivre les instructions données dans cette notice pour réduire au minimum le risque d'incendie ou d'explosion ou pour éviter tout dommage matériel, toute blessure ou la mort.

- Ne pas entreposer ni utiliser d'essence ou ni d'autres vapeurs ou liquides inflammables à proximité de cet appareil ou de tout autre appareil.
- Avant d'opérer, sentir le gaz autour de la zone de l'appareil. Assurez-vous de sentir à côté du sol car certains gaz sont plus lourds que l'air et se déposeront sur le sol.
- QUE FAIRE SI VOUS SENTEZ UNE ODEUR DE GAZ :
 - Ne pas tenter d'allumer d'appareil.
 - Ne touchez à aucun interrupteur ; ne pas vous servir des téléphones se trouvant dans le bâtiment.
 - Appelez immédiatement votre fournisseur de gaz depuis un voisin. Suivez les instructions du fournisseur.
 - Si vous ne pouvez rejoindre le fournisseur, appelez le service des incendies.
- L'installation et l'entretien doivent être assurés par un installateur ou un service d'entretien qualifié ou par le fournisseur de gaz.

- Keep the area around the appliance clear and free from combustible materials, gasoline, and other flammable vapors and liquids.
- Do not use this appliance if any part has been under water. Immediately call a licensed professional to inspect the appliance and to replace any part of the control system and any gas control which has been under water. *(N'utilisez pas cet appareil s'il a été plongé dans l'eau, même partiellement. Faites inspecter l'appareil par un licence professionnelle et remplacez toute partie du système de contrôle et toute commande qui ont été plongés dans l'eau.)*
- Should overheating occur or the gas supply fail to shut off, turn off the manual gas control valve to the appliance. *(En cas de surchauffe ou si l'alimentation en gaz ne s'arrête pas, fermez manuellement le robinet d'arrêt de l'admission de gaz.)*
- Use only your hand to push in or turn the gas control knob. Never use tools. If the knob will not push in or turn by hand, do not try to repair it, call a licensed professional. Force or attempted repair may result in a fire or explosion.
- This appliance does not have a pilot. It is equipped with an ignition device which automatically lights the burner. DO NOT try to light the burner by hand.
- Do not use an extension cord or an adapter plug with this appliance.
- Any alteration to the appliance or its controls can be dangerous and will void the warranty.
- If you install this water heater in an area that is known to have hard water or that causes scale build-up the water must be treated and/or the heat exchanger flushed regularly. Rinnai provides a "Scale Control System" that offers superior lime scale prevention and corrosion control by feeding a blend of control compounds into the water supply. Damage and repair due to corrosive compounds in the air is not covered by warranty.
- Keep the combustion air vent pipe location free of chemicals, such as chlorine or bleach, that produce fumes. These fumes can damage components and reduce the life of your appliance. Damage and repair due to scale in the heat exchanger is not covered by warranty.
- Always check the water temperature before entering a shower or bath.
- Do not adjust the parameter settings unless specifically instructed to do so.

4.2 Controller

The controller panel allows you to adjust the water temperature, lock the controller on a set temperature, and view diagnostic information.

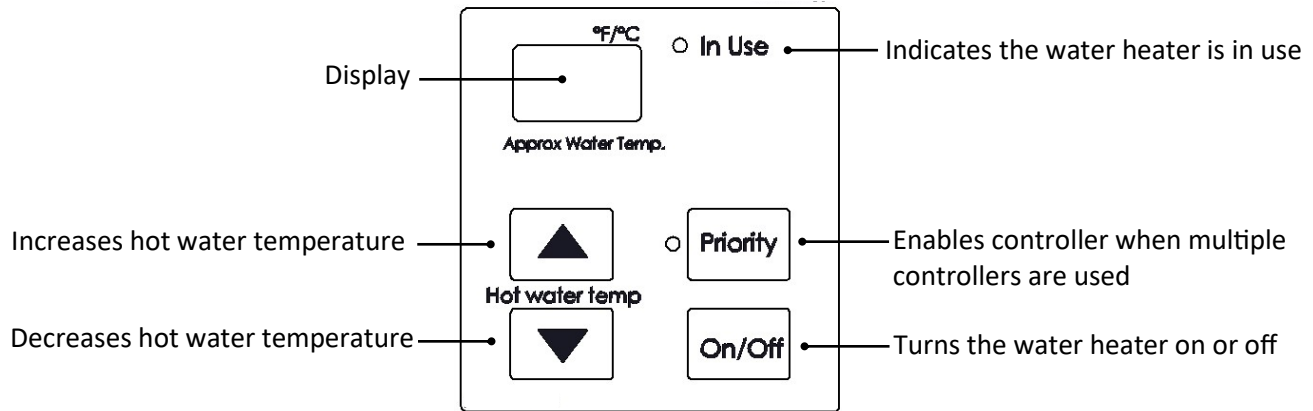

Setting the Controller to Mute

To eliminate the beeps when keys are pressed, press and hold both the ▲ (Up) and ▼ (Down) buttons at the same time until a beep is heard (approximately 3 seconds). Then, release both buttons.

To turn on the beeps, repeat the above steps.

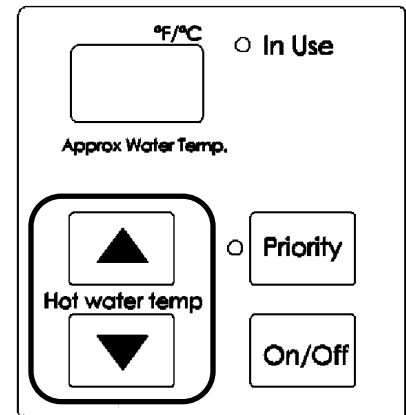

Locking the Controller

1. To lock the internal controller, press and hold down the "Priority" button.
2. While holding down the "Priority" button, press the ▲ (Up) button until a beep is heard (approximately 5 seconds). Then, release both buttons at the same time.
3. `LOC` appears in the display indicating the controller is locked.

Note: The display flashes between `LOC` and the set temperature to indicate the controller is locked.

To unlock the controller, follow the above steps.

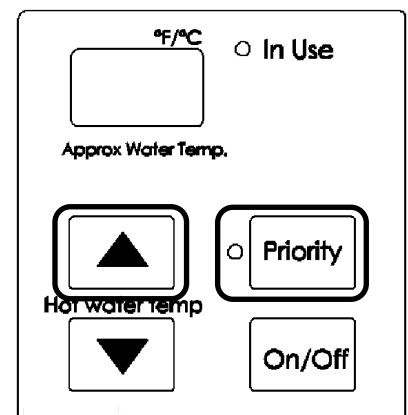

4.3 Setting the Temperature

This water heater requires a minimum flow rate to operate. This rate can be found on the specification page in this manual. In some cases when you are not getting hot water or if the water alternates between hot and cold, it is due to the water flow being below or close to the minimum flow rate. Increasing the flow rate should resolve these problems in these cases.

If you are experiencing issues with higher temperature settings, then reduce the temperature setting. Selecting a temperature closer to that which is actually used at the faucet will increase the amount of hot water being delivered to the faucet, due to less cold water mixing at the fixture.

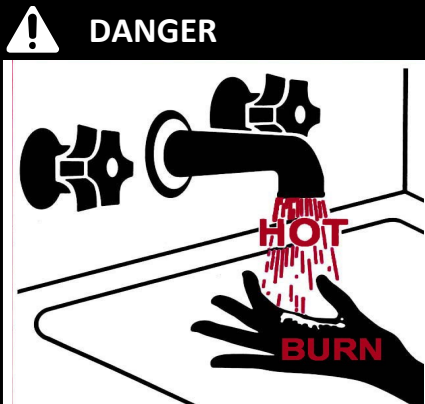
	<p>DANGER</p> <p>Water temperatures over 125° F (52° C) can cause severe burns or scalding resulting in death.</p> <p>Hot water can cause first degree burns with exposure for as little as:</p> <ul style="list-style-type: none">3 seconds at 140° F (60° C)20 seconds at 130° F (54° C)8 minutes at 120° F (49° C) <p>Children, disabled, or elderly are at highest risk of being scalded.</p> <p>Feel water before bathing or showering.</p>
--	---

NOTICE	While any hot water is being provided, the temperature setting can only be adjusted between 98° F and 110° F.
---------------	---

NOTICE	Check local codes for the maximum water temperature setting allowed when used in nursing homes, schools, day care centers, and all other public applications.
---------------	---

NOTICE	If a newly installed water heater with a controller has not been powered for at least 6 hours then the temperature will return to the default setting of 104° F (40° C) if power is interrupted.
---------------	--

NOTICE	There may be a variation between the temperature displayed on the temperature controller and the temperature at the tap due to weather conditions or the length of pipe to the water heater.
---------------	--

The controller buttons shown below are located on the outside front panel for internal (indoor) water heaters. For external (outdoor) water heaters, open the front panel to access the controller buttons.

1. If the water heater is off, press the “On/Off” button to turn on.
2. The “Priority” button enables a controller if multiple controllers are being used. If the “Priority” light is off, then press the “Priority” button on the temperature controller. The orange “Priority” light will glow indicating that this controller is controlling the temperature and that the water heater is ready to supply hot water. The priority can only be changed while no hot water is running.
3. Press the ▲ (Up) or ▼ (Down) buttons to obtain the desired temperature setting.

All hot water sources are able to provide water at this temperature setting until it is changed again at this or another temperature controller.

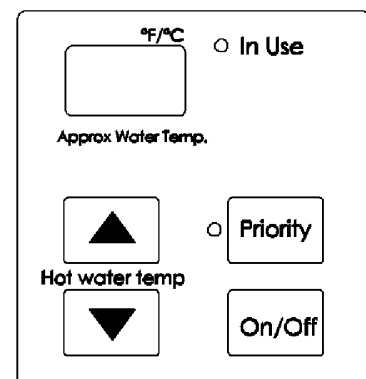

Available Temperatures with an Internal Controller

The water heater can deliver water at only one temperature setting at a time. The available temperatures are provided below. A temperature lower than 98° F (37° C) can be obtained at the tap by mixing with cold water.

To change the temperature scale from Celsius to Fahrenheit or vice versa, press and hold the “On/Off” button on the controller for 5 seconds while the water heater is OFF.

Temperature Settings																	
Parameter Setting a	°F	98	100	102	104	106	108	110	115	120	125	130	135	140*			
	°C	37	38	39	40	41	42	43	46	49	52	54	57	60			
Parameter Setting b	°F	110	115	120	125	130	135	140	145	150	155	160	165	170	175	180	185
	°C	43	46	49	52	54	57	60	63	66	68	71	74	77	79	82	85

These models have a default maximum temperature of 140° F (60° C) and an option to increase the maximum temperature to 185° F (85° C) with parameter adjustment. Refer to section “3.12 Parameter Settings” for further details.

4.4 Performance Data

To Obtain Performance Data:

1. Press and hold the ▼ (Down) button.
2. While holding the ▼ (Down) button for 2 seconds, press and hold the “On/Off” button (hold both buttons simultaneously).

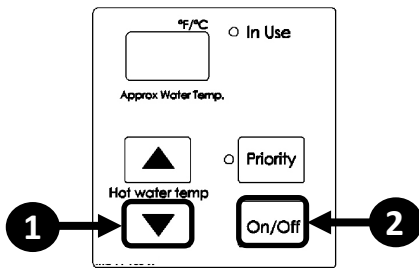

3. Use the ▲ (Up) and ▼ (Down) buttons to scroll to the desired information described in the Performance Data Table.

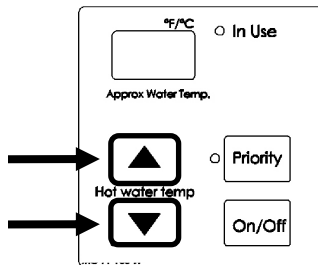

4. To exit performance data, repeat step 2 above.
5. When complete, the set temperature appears in the display.

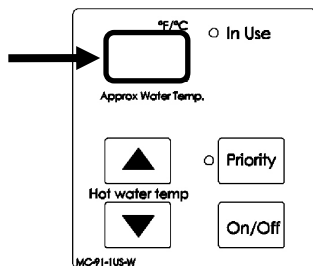

Performance Data Table

#	DATA	UNIT
01	Water Flow Rate	x0.1 gal/min
02	Outgoing Temperature	°F
03	Combustion Hours	x100 Hours
04	Combustion Cycles	*
05	Fan Frequency	Hz
06	Additional Controllers Connected	*
07	Water Flow Control Position	0=mid, 1=Open, 2=Closed
08	Inlet Temperature	°F
09	Fan Current	x10 mA
10	Total Bath Fill Amount	Gallons
11	HEX Outlet Temperature	°F
12	By-Pass Flow Control Position	Degrees of opening
15	Freeze Protection Temperature (Indoor Units Only)	°F
17	Freeze Protection Temperature (Outdoor Units Only)	°F
19	Pump Hours	x100 Hours
20	Pump Cycles	*
21	Exhaust Temperature	°F

* Refer to the Technical Data Sheet located on the inside front cover of the water heater for additional information.

4.5 Diagnostic Codes

To display diagnostic codes:

1. Turn off the water heater by pressing the “On/Off” button.
2. Press and hold the “On/Off” for 2 seconds and then the ▲ (Up) button simultaneously.
3. The last nine maintenance codes display and flash one after the other.
4. To exit diagnostic codes and return the water heater to normal operation, press and hold the “On/Off” button for 2 seconds and then the ▲ (Up) button simultaneously.
5. Turn on the water heater by pressing the “On/Off” button.

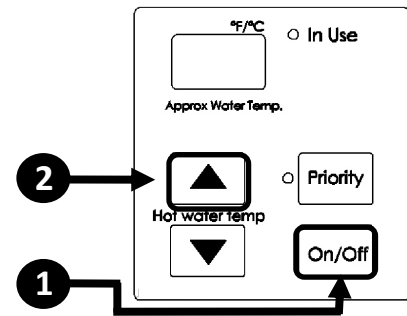

⚠ WARNING

Some of the checks below should be performed by a licensed professional. Consumers should never attempt any action that they are not qualified to perform.

03 Power interruption during bath fill (Water will not flow when power returns) <ul style="list-style-type: none"> • Turn off all hot water taps. Press ON/OFF twice. 	12 No Flame <ul style="list-style-type: none"> • Check that the gas is turned on at the water heater, gas meter, or cylinder. • If the system is propane, make sure that gas is in the tank. • Ensure flame rod wire is connected. • Ensure gas type and inlet gas pressure is correct. • Bleed all air from gas lines.
05 By-Pass Flow Control <ul style="list-style-type: none"> • Measure resistance values of the by-pass flow control.* • Replace By-Pass flow control device. 	14 Heat Exchanger Overheat <ul style="list-style-type: none"> • Measure resistance of Overheat Switch.* • Check heat exchanger surface for hot spots which indicate blockage due to scale build-up. • Refer to instructions in manual for flushing heat exchanger. Hard water must be treated to prevent scale build up or damage to the heat exchanger. • Ensure it is not in forced Hi setting.
10 Air Supply or Exhaust Blockage/Condensate Trap is Full <ul style="list-style-type: none"> • Ensure condensate line is not blocked. • Ensure internal air filter is clean with no obstructions. (Indoor Water Heaters Only) • Ensure High Altitude setting. (See Parameter Settings) • Ensure Combustion air and Exhaust vents are not blocked and approved venting materials are being used. (Indoor Water Heaters Only) • Ensure vent length is within limits. (Indoor Water Heaters Only) • Check fan for debris and ensure wheel turns freely. • Verify check valve is not stuck between fan casing and burner body. 	15 Venturi Control <ul style="list-style-type: none"> • Ensure the Venturi motor is operating correctly.* • Replace gas valve assembly. • Clear diagnostic code by resetting the main power supply to the water heater.
11 No Ignition (Heater Not Turning On) <ul style="list-style-type: none"> • Check that the gas is turned on at the water heater, meter, or cylinder. • If the system is propane, make sure that gas is in the tank. • Ensure gas type and inlet gas pressure are correct. • Bleed all air from gas lines. • Check the ground wire for the PC Board. • Ensure flame rod wire is connected. • Ensure igniter is operational.* • Check gas solenoid valves for open or short circuits.* • Verify gas orifice is correct. 	16 High Outgoing Temperature (safety shutdown because water heater is too hot) <ul style="list-style-type: none"> • Confirm fan motor is functioning correctly. • Replace the gas valve assembly.
	17 Venturi Blockage <ul style="list-style-type: none"> • First, follow the recommended solutions for Diagnostic Code 10. • If the Code 10 solutions do not correct the problem, ensure the Venturi is not blocked. • Please call Rinnai technical department.
	19 Electrical Grounding <ul style="list-style-type: none"> • Check all components for electrical short.

* See “Electrical Diagnostics” on Technical Data Sheet located on inside front cover of water heater.

19	Electrical Grounding	<ul style="list-style-type: none"> Check all components for electrical short.
21	Data Transfer Error	<ul style="list-style-type: none"> If the PCB has been replaced, ensure the data transfer process has been completed.
25	Condensate Pump (Accessory)	<ul style="list-style-type: none"> Confirm wire connections and harness are good. Ensure condensate reservoir is empty and condensate pump is operating.
32	Outgoing Thermistor	
33	Heat Exchanger Thermistor	<ul style="list-style-type: none"> Check sensor wiring for damage. Measure resistance of sensor.* Clean sensor of scale build-up. Replace sensor.
38	Exhaust Thermistor	
41	Freeze Protection Thermistor	<ul style="list-style-type: none"> Check sensor wiring for damage. Measure resistance of sensor.* Replace sensor.
51	Inlet Thermistor	<ul style="list-style-type: none"> Check sensor wiring for damage. Measure resistance of sensor.* Clean sensor of scale build-up. Replace sensor.
52	Gas Valve	<ul style="list-style-type: none"> Check flame rod and wire for damage. Check gas solenoid valve for open or short circuit.* Replace gas valve assembly. Please call Rinnai technical department
54	High Exhaust Gas Temperature	<ul style="list-style-type: none"> Ensure Heat Exchanger fins are clean and not blocked. Confirm inlet water temperature is not too high. Clear diagnostic code by resetting the main power supply to the water heater.
61	Combustion Fan	<ul style="list-style-type: none"> Check the motor wire harness for loose or damaged connections. Measure resistance of motor wire harness. * Ensure the combustion fan spins freely.
FF	Maintenance Indicator	<ul style="list-style-type: none"> Placeholder in Diagnostic code history indicating that a service provider performed maintenance or service. Enter this code after performing service by pressing ▲ (Up), ▼ (Down) and On/Off simultaneously. FF is visible on the monitor.
63	Recirculation Low Flow	<ul style="list-style-type: none"> Ensure bypass plug is removed and bypass filter is installed. (COV Mode) Ensure both the inlet water filter and bypass filter are clean and free of debris. Ensure Parameter setting are correctly set for recirculation mode. Ensure Pump supply voltage. Ensure air is removed from the recirculation line.
65	Water Flow Control	<ul style="list-style-type: none"> Measure resistance values of the water flow control.* The water flow control valve has failed to close during the bath fill function. Immediately turn off the water and discontinue the bath fill function. Contact a licensed professional to service the appliance.
70	PC Board	<ul style="list-style-type: none"> Replace PC Board
71	Solenoid Valve Circuit	<ul style="list-style-type: none"> Ensure dip switch on PC board is in the OFF position. Ensure gas control wire is not loose or damaged. Ensure heater circuit is not grounded. Replace PC Board.
72	Flame Rod	<ul style="list-style-type: none"> Check flame rod and wire for damage. Verify HEX is not leaking.
55	(55) Service Soon (Flush Heat Exchanger)	<ul style="list-style-type: none"> 55 is a time-based service indicator set during installation. See section “3.12 Parameter Settings” for additional details on setting and changing the 55 indicator. 55 indicates that it is time for service. The heat exchanger should be flushed to prevent damage (refer to section “5.3 Flushing the Heat Exchanger” for more information). Hard water must be treated to prevent scale build-up or damage to the heat exchanger. To reset the 55 code, push the On/Off button on the temperature controller 5 times in 5 seconds.
NO CODE - Nothing happens when water flow is activated		<ul style="list-style-type: none"> Verify you have at least the minimum flow rate required to fire unit. Measure the resistance of the water flow control sensor.* Clean inlet water supply filter. On new installations ensure hot and cold water lines are not reversed.
5E	Cascade Diagnostic Display (Commercial units only)	<ul style="list-style-type: none"> With cascade connections, display will flash between “5E” and the selected set temperature when an error code is displayed on any secondary unit.

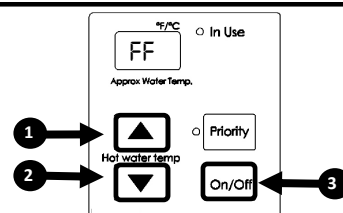

* See “Electrical Diagnostics” on Technical Data Sheet located on inside front cover of water heater.

5. Maintain the Water Heater

This water heater must be inspected annually by a licensed professional. Repairs and maintenance shall be performed by a licensed professional. The licensed professional must verify proper operation after servicing.

WARNING

To protect yourself from harm, before performing maintenance:

- Turn off the electrical power supply by unplugging the power cord or by turning off the electricity at the circuit breaker. (The temperature controller does not control the electrical power.)
- Turn off the gas at the manual gas control valve, usually located immediately below the water heater.
- Turn off the incoming water supply. This can be done at the isolation valve immediately below the water heater or by turning off the water supply to the building.

WARNING

Keep the appliance area clear and free from combustible materials, gasoline, and other flammable vapors and liquids.

5.1 Maintenance

The following maintenance items are required for the proper operation of your water heater.

The appliance must be inspected annually by a licensed professional. Repairs and maintenance shall be performed by a licensed professional. The licensed professional must verify proper operation after servicing.

CLEANING

It is imperative that control compartments, burners, and circulating air passageways of the appliance be kept clean. Check burner flame for proper color. Once ignited, the flame must cover the surface of the burner. The flame must burn with a clear, blue, stable flame. If the flame does not have this appearance, complete the following steps:

1. Turn off and disconnect electrical power. Allow to cool.
2. Remove the front panel by removing four screws.
3. Use a vacuum to remove dust from the main burner and fan blades. Do not use a wet cloth or spray cleaners on the burner. Do not use volatile substances such as benzene and thinners; they may ignite or fade the paint.
4. Use soft dry cloth to wipe cabinet.

VENT SYSTEM

The vent system should be inspected at least annually for blockages or damage. If the vent is blocked contact a licensed professional.

MOTORS

Motors are permanently lubricated and do not need periodic lubrication. However you must keep fan and motor free of dust and dirt by cleaning annually.

TEMPERATURE CONTROLLER

Use a soft damp cloth to clean the temperature controller. Do not use solvents.

LIME/SCALE BUILD-UP

Scale build-up is caused by hard water and can be accelerated if the water heater is set at a high temperature. Refer to section “5.3 Flushing the Heat Exchanger” for more information. Refer to section “Water Quality Guidelines” to determine if your water needs to be treated or conditioned. **The water must be potable, free of corrosive chemicals, sand, dirt, or other contaminants. It is up to the installer to ensure the water does not contain corrosive chemicals or elements that can affect or damage the Rinnai Tankless Water Heater. Water that contains chemicals exceeding the levels described in the Water Quality Guidelines sections of this manual can damage the Rinnai Tankless Water Heater. Replacement of the heat exchanger due to water quality damage is not covered by the warranty.**

SNOW ACCUMULATION

- Keep the area around flue terminal free of snow and ice. The water heater will not function properly if the combustion air or exhaust vent pipes are impeded (blocked or partially blocked) by obstructions.
- Keep the condensate drain line free of snow and ice. Ensure the line is not blocked or clogged and that condensate is flowing freely.

COASTAL INSTALLATIONS

Installations located in or near coastal areas may require additional maintenance due to corrosive airborne ocean salt. If corrosion is observed on the body of the water heater, the water heater shall be inspected to ensure proper operation and if necessary, repaired or replaced.

FILTERS

- **Water Filter** — Clean the inlet water filter by closing the cold and hot water inlet isolation (shut-off) valves. Put a bucket under the filter at the bottom of the water heater to catch any water that is contained inside the unit. Unscrew the water filter. Rinse the filter to remove any debris. Install the filter and open the isolation valves.
- **Air Filter** — See section “5.2 Cleaning and Inspecting the Air Filter” for more information.

PRESSURE RELIEF VALVE

Operate the pressure relief valve manually once a year. In doing so, it will be necessary to take precautions with regard to the discharge of potentially scalding hot water under pressure. Ensure discharge has a safe place to flow. Contact with your body or other property may cause damage or harm.

WARNING

Testing the pressure relief valve should only be performed by a licensed professional. Water discharged from the pressure relief valve could cause severe burns instantly or death from scalds.

VISUAL INSPECTION OF FLAME

Verify proper operation after servicing. The burner must flame evenly over the entire surface when operating correctly. The flame must burn with a clear, blue, stable flame. See the parts breakdown of the burner for the location of the view ports.

The flame pattern should be as shown in the images below:

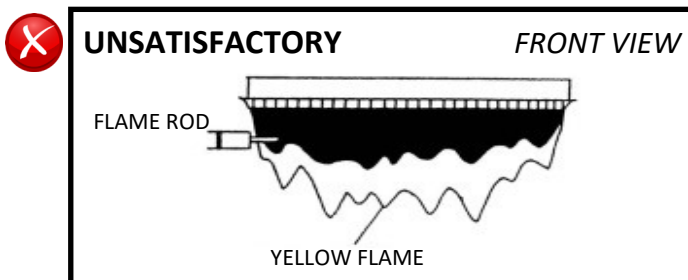
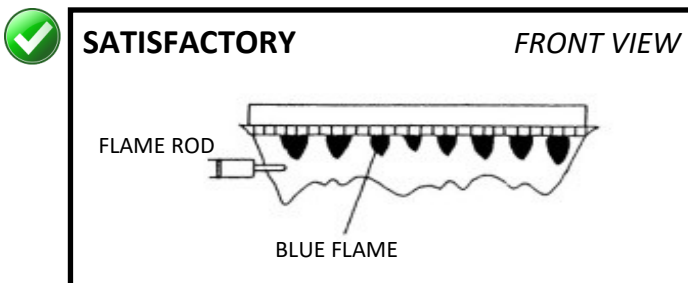

FREEZE PROTECTION

Make sure in case of freezing weather that the water heater and its water lines are adequately protected to prevent freezing. Damage due to freezing is not covered by the warranty. Refer to the “Freeze Protection” section (Section 3.2 **Choose an Installation Location > Freeze Protection**). The water heater may be drained manually. However, it is highly recommended that drain down solenoid valves be purchased and installed, which will automatically drain the water heater if power is lost. (The condensate trap drain plug and Pressure Relief Valve are not affected by the auto drain down solenoid valves and will have to be manually opened.)

WINTERIZATION

The following recommendations are intended to suggest practices that are effective for winterizing the water heater. They should be used as a guide only. No liability is assumed for any issues resulting from the use of this information.

Note: See section “5.4 Draining the Water Heater” for detailed instructions on:

- Draining the water heater
- Running a low volume of water through the water heater to prevent freezing
- Steps to take when the water heater or external pipes have frozen
- **Gas**
 - Shut off the gas to the water heater. It is generally preferable to shut off the gas service to the entire location if gas is not going to be used.
- **Water**
 - Shut off the cold water supply to the water heater. It is generally preferable to shut off the water to the entire location if water is not going to be used.
 - Drain the water heater by opening the drain valves on the cold water line and hot water line.
 - Open several hot water taps and remove the filter assembly at the water inlet in order to allow room for expansion in case there is water in the lines that freeze.
- **Condensate**
 - Drain the condensate using the condensate drain port on the bottom of the water heater.
- **Electric**
 - Disconnect the power supply by either unplugging the electrical cord or by turning off the circuit breaker to the water heater to prevent potential damage from irregular power surges or interruptions.

5.2 Cleaning and Inspecting the Air Filter (Indoor Units Only)

INSPECTION

- To maintain optimum performance, periodically inspect the air filter.
- If the air filter appears to have lint and/or dust build up, follow the cleaning procedure described below.
- If the air filter appears damaged, contact a trained and qualified professional for a replacement air filter assembly.

CLEANING

1. Power OFF the water heater
 - Push the “On/Off” button located on the right-hand side of the controller.
 - The display will go blank when the power is off.
2. Remove the front panel.
 - Remove four screws securing the front panel.
 - Remove the front panel and locate the filter at the upper right-hand corner of the water heater.
 - Remove the air filter by pulling out the “FILTER Pull to Clean” tab.

3. Clean the Air Filter

- With mild dish soap and a soft bristle brush, scrub the filter area of the air filter door.
- With clean water, rinse the soap off the filter.

4. Dry the Air Filter

- With a lint free towel, dry the air filter.

5. Inspect and Replace the Air Filter

- Inspect the air filter for any debris that may restrict air flow to the water heater.
- If the filter still appears dirty repeat the cleaning steps.
- Replace the air filter.

6. Power ON the water heater.

NOTE: Do not operate this water heater if the air filter is not in place.

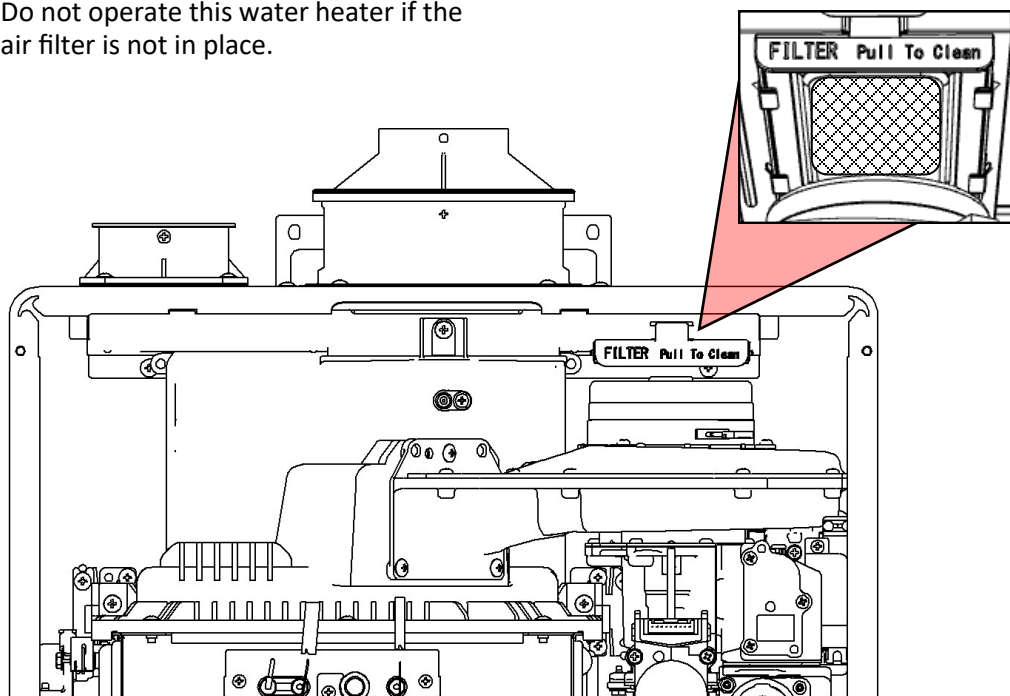

5.3 Flushing the Heat Exchanger

This water heater includes a service indicated/reminder (Service Soon, 55). When selected in the parameter settings, an 55 code will display on the controller indicating that it is time to flush and service the water heater. Failure to flush the appliance will cause damage to the heat exchanger. Damage caused by lime build-up is not covered by the water heater's warranty. Rinnai strongly recommends installation of isolation valves to allow for flushing of the heat exchanger.

1. Turn off power at the controller.
2. Disconnect electrical power to the water heater.
3. Close the shutoff valves on both the hot water and cold water lines (V3 and V4).
4. Connect pump outlet hose (H1) to the cold water line at service valve (V2).
5. Connect drain hose (H3) to the hot water line at service valve (V1).
6. Pour four gallons of undiluted virgin, food grade, white vinegar into pail.
7. Place the drain hose (H3) and the hose (H2) to the pump inlet into the cleaning solution.
8. Open both service valves (V1 and V2) on the hot water and cold water lines.
9. Operate the pump and allow the vinegar to circulate through the water heater for at least 1 hour at a rate of 4 gallons per minute (15.1 liters per minute).
10. Turn off the pump.
11. Rinse the vinegar from the water heater as follows:
 - a. Remove the free end of the drain hose (H3) from the pail. Place in sink or outside to drain.
 - b. Close service valve (V2) and open shutoff valve (V4). Do not open shutoff valve (V3).
 - c. Allow water to flow through the water heater for five minutes.
 - d. Close shutoff valve (V4). When unit has finished draining remove the in-line filter at the cold water inlet and clean out any residue. Place filter back into unit and open valve (V4).
 - e. Close service valve (V1) and open shutoff valve (V3).
12. Disconnect all hose
13. Restore electrical power to the water heater.

NOTE:

Scale build-up will affect the performance of the water heater. Water should be treated. Rinnai offers Southeastern Filtration's "ScaleCutter Water Conditioning System" that offers superior lime scale prevention and corrosion control by feeding a blend of control compounds into the cold water supply.

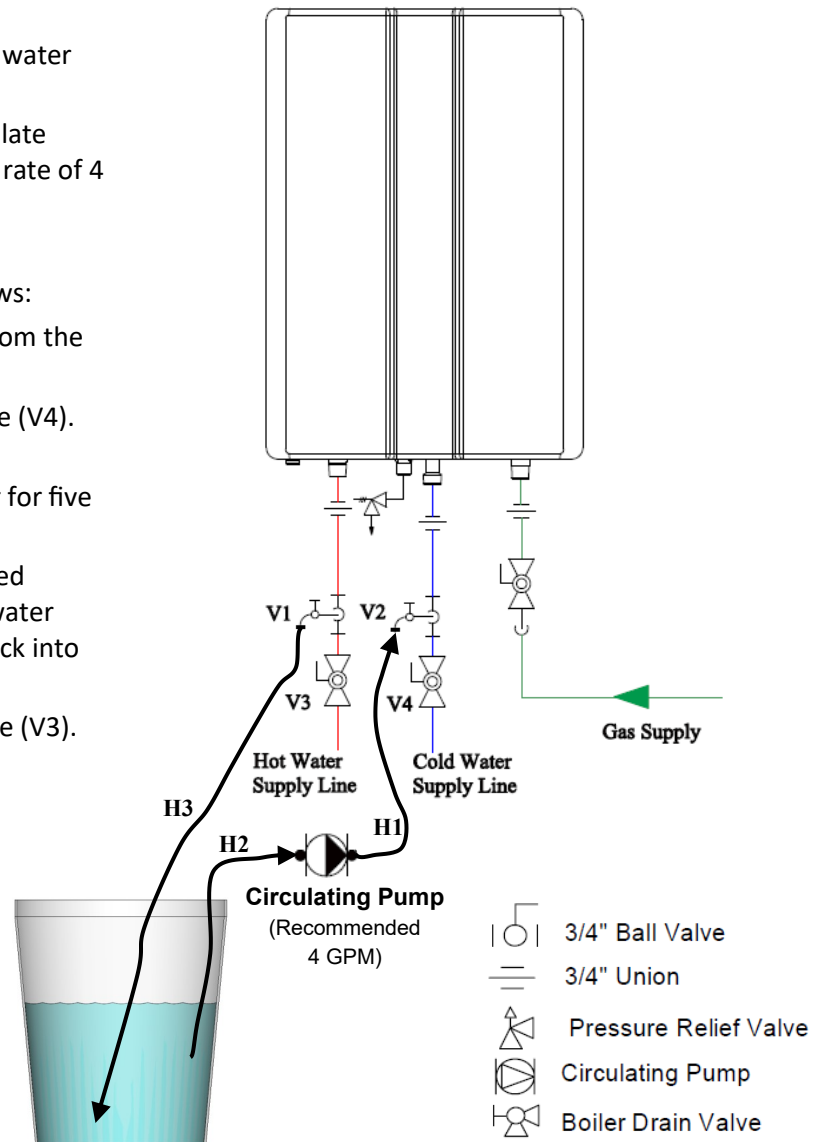

5.4 Draining the Water Heater



WARNING

To avoid burns, wait until the equipment cools down before draining the water. The water in the appliance will remain hot after it is turned off.

If the water heater is not going to be used during a period of possible freezing weather, it is recommended that the water inside the water heater be drained.

To manually drain the water:

1. Shut off cold water supply and gas supply.
2. Turn off the temperature controller.
3. Disconnect the power to the water heater.
4. Close the hot and cold isolation valves.
5. Open the pressure relief valve (PRV) lever.
6. Open the hot and cold drain valves.
7. Remove the condensate trap drain plug and allow to drain.
8. Remove the pump drain plug (*only for pump version*).

To resume normal operation:

1. Confirm that the gas supply is turned off, all taps are closed and PRV lever is closed.
2. Insert the condensate trap drain plug.
3. Close the hot and cold drain valves.
4. Open the cold and hot water isolation valves.
5. Open a tap and confirm that water flows, and then close.
6. Connect power to the water heater.
7. After confirming that the temperature controller is off, turn on the gas supply.
8. Turn on the temperature controller.

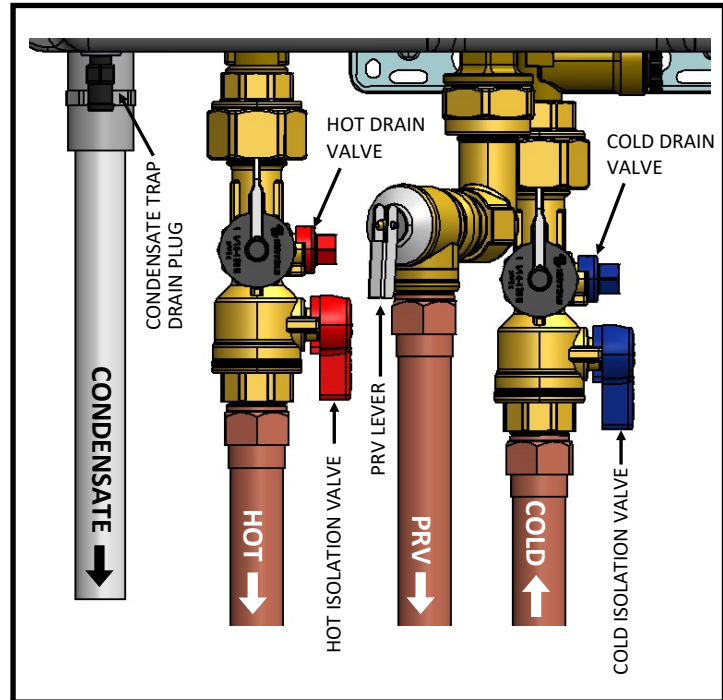

Piping Diagram

Running a low volume of water through the water heater to prevent freezing:

If the temperature exceeds the ability of the water heater to freeze protect itself, or if power is lost, the following steps may prevent the water heater and external piping from freezing. Units connected with EZConnect™ (2-unit link) should be drained to prevent freezing if not in use.

1. Turn the water heater off.
2. Close the gas supply valve.
3. Turn on a hot water tap to flow water about 0.1 gal/min (0.4 L/min) or where the stream is about 0.2 in. (5 mm) thick.

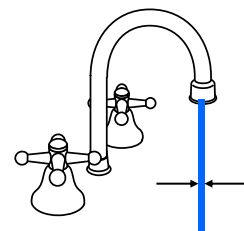

When the water heater or external piping has frozen:

1. Do not operate the water heater if it or the external piping is frozen.
2. Close the gas and water valves and turn off the power.
3. Wait until the water thaws. Check by opening the water supply valve.
4. Check the water heater and the piping for leaks.

6. Appendices

6.1 Wiring Diagram

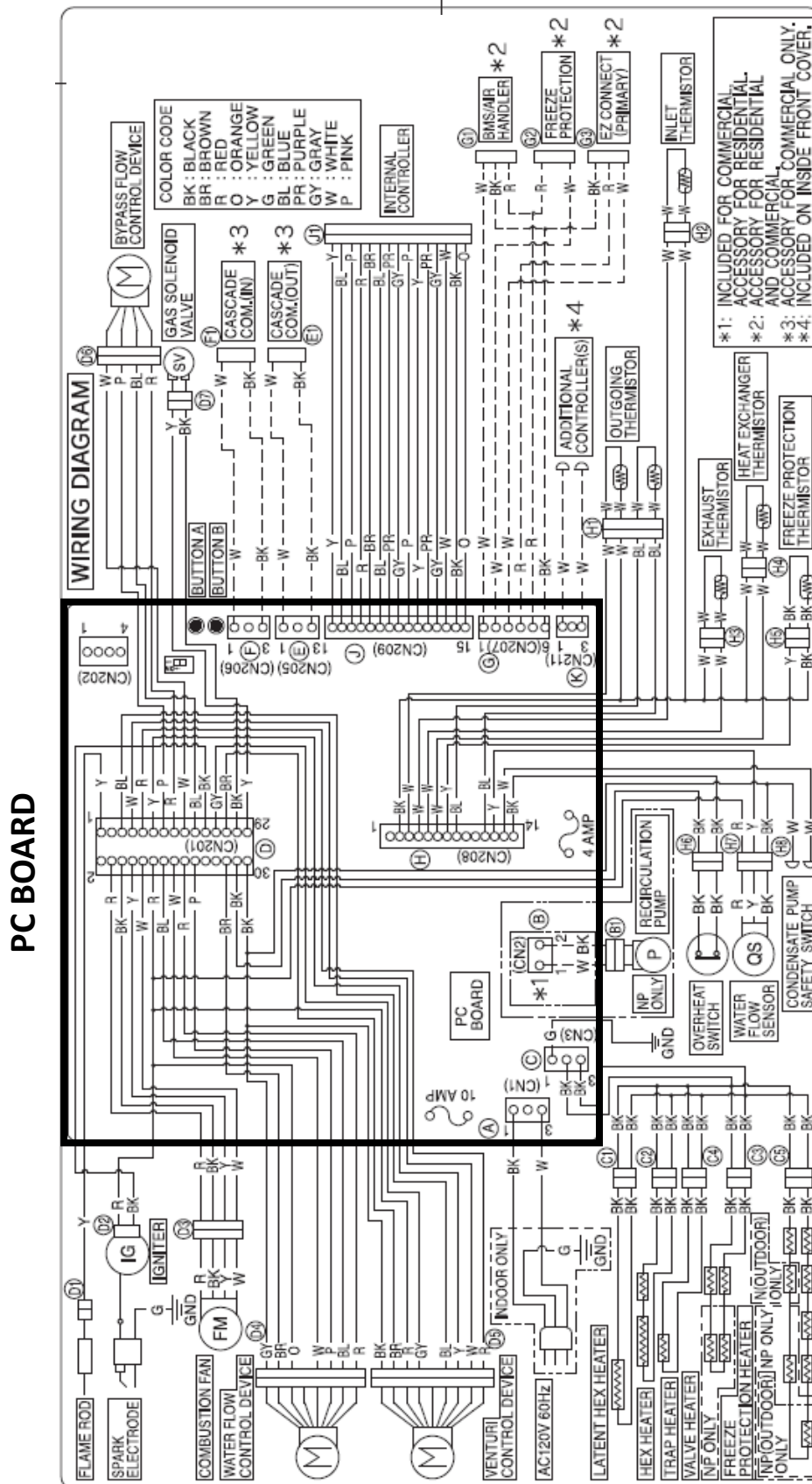

6.2 Ladder Diagram

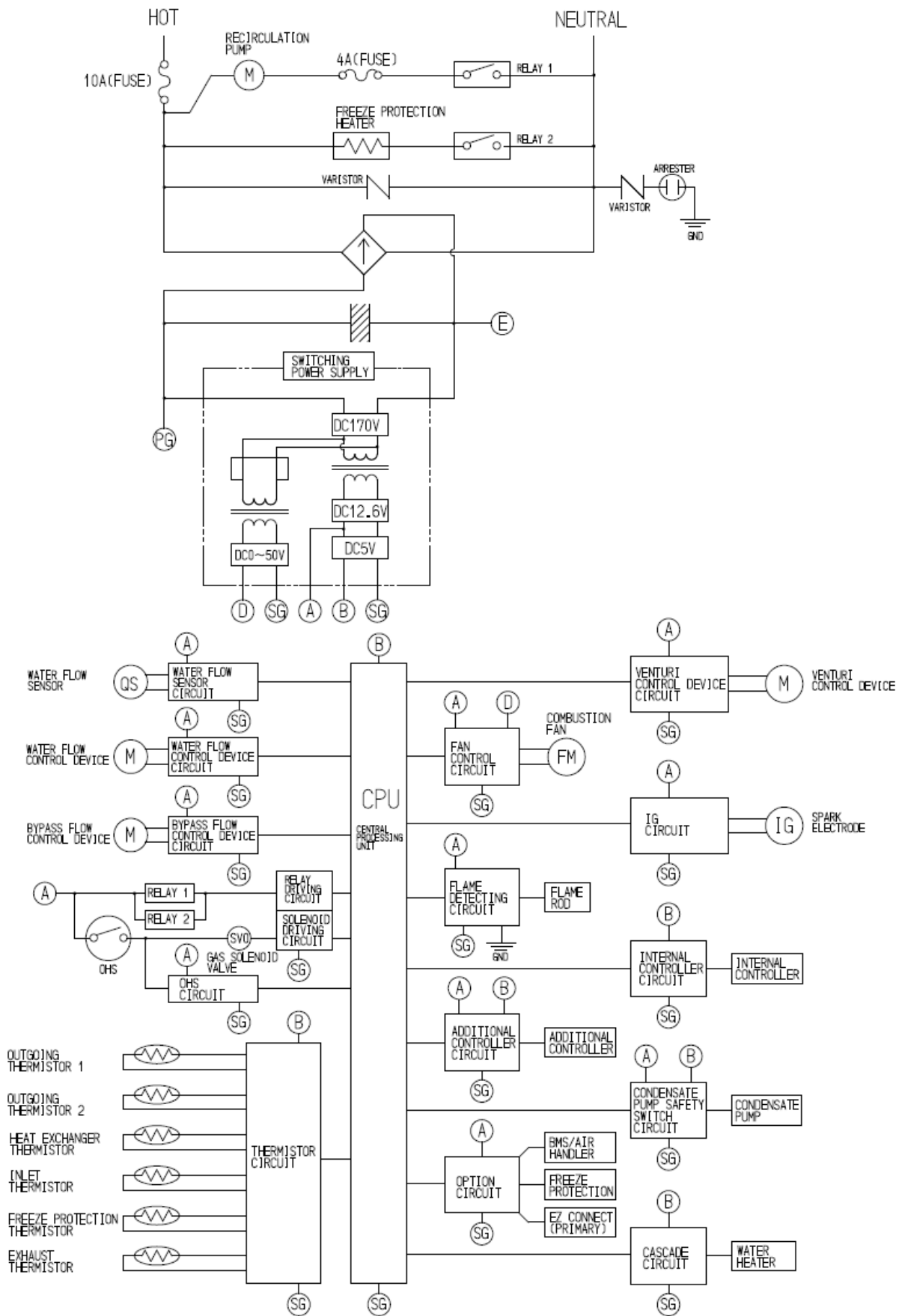

6.3 Pressure Drop and Water Flow Curves

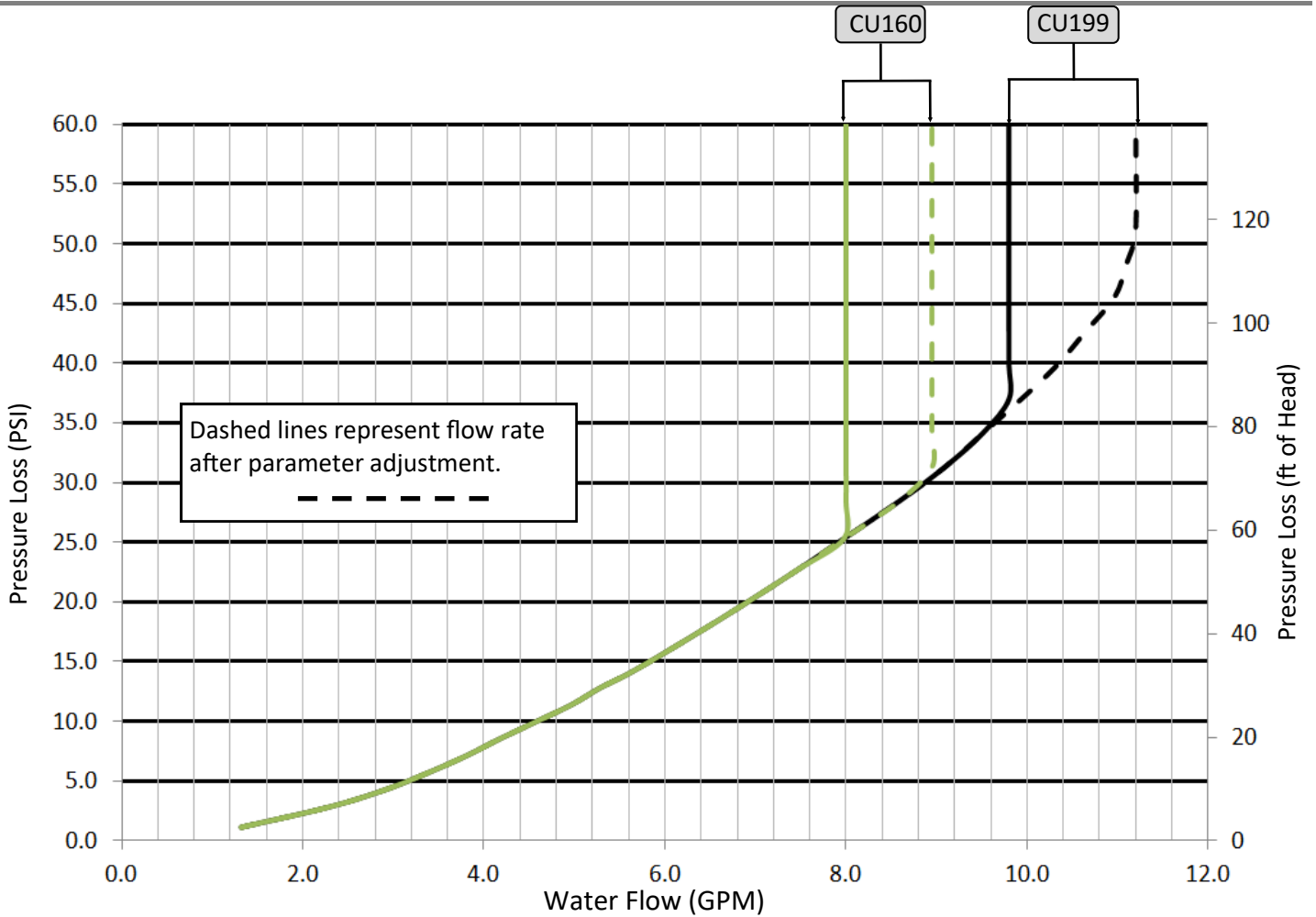

The chart below applies only to incoming water temperatures of 70° F (21° C) or less. For incoming water temperatures greater than 70° F (21° C), please contact Rinnai.

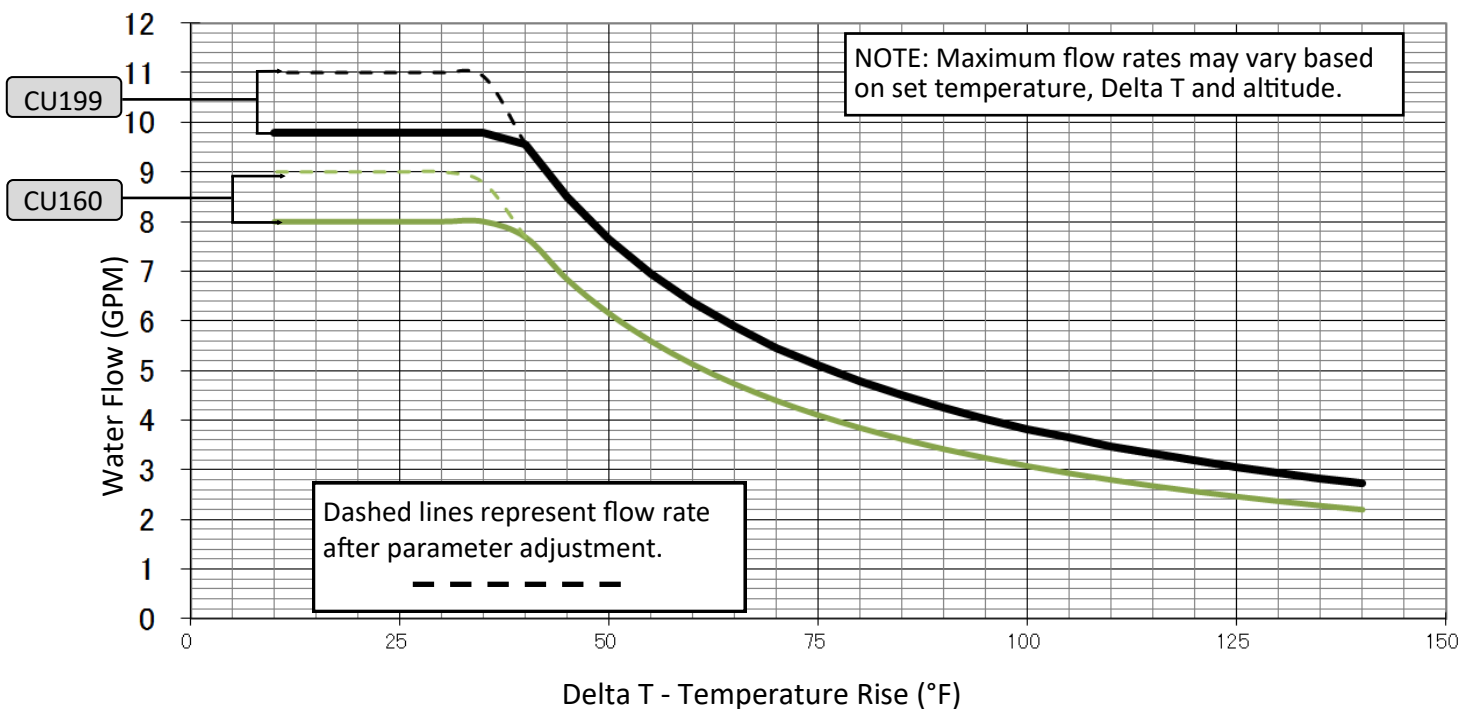

6.4 Guidelines for Additional Temperature Controllers

All Rinnai Tankless Water Heaters are equipped with an integrated digital temperature controller that allows for a precise water temperature set-point. Additional digital temperature controllers are available as accessories and must be purchased separately (detailed installation steps included with purchase).

Wiring

A maximum of four temperature controllers can be installed for a water heater or bank of water heaters; this includes the controller built into a Rinnai Tankless Water Heater. Controllers can only be wired in parallel; they cannot be wired in series.

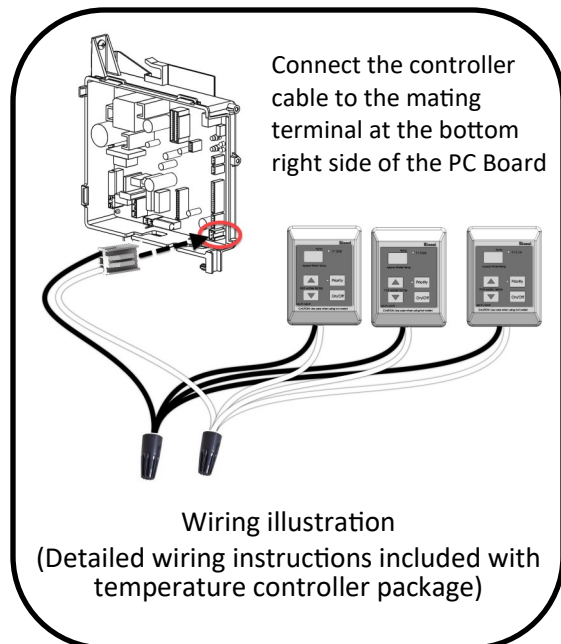
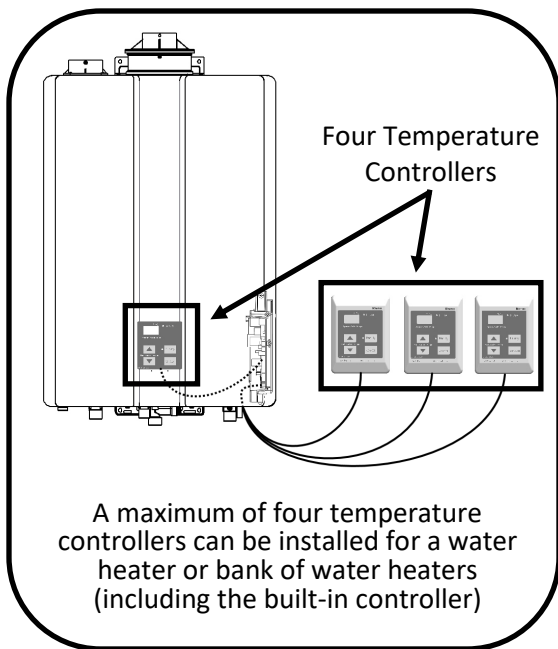

Cable Lengths and Sizes

The temperature controller cable should be a non-polarized two-core cable with a minimum gauge of 22 AWG. The maximum cable length from each temperature controller to the water heater depends on the total number of wired controllers connected to the water heater.

Number of Wired Controllers	Maximum Cable Length for Each Controller to Water Heater
1	328 ft (100 m)
2	164 ft (50 m)
3 or 4 *	65 ft (20 m)

* Only three additional controllers can be wired to the water heater.

Location

- The temperature controller should be out of reach of small children.
- Avoid locations where the temperature controller may become hot (near an oven or radiant heater).
- Avoid locations in direct sunlight. The digital display may be difficult to read in direct sunlight.
- Avoid locations where the temperature controller could be splashed with liquids.
- Do not install in locations where the temperature controller can be adjusted by the public.

6.5 Massachusetts State Gas Regulations

FOR GAS MODELS SOLD IN MASSACHUSETTS

NOTICE BEFORE INSTALLATION:

This direct-vent appliance must be installed by a properly trained licensed professional. If you are not properly trained, you must not install this unit.

IMPORTANT: In the State of Massachusetts (248 CMR 4.00 & 5.00):

For all side wall horizontally vented gas fueled equipment installed in every dwelling, building or structure used in whole or in part for residential purposes, including those owned or operated by the Commonwealth and where the side wall exhaust vent termination is less than 7 ft above finished grade in the area of the venting, including but not limited to decks and porches, the following requirements shall be satisfied:

1. **INSTALLATION OF CARBON MONOXIDE DETECTORS.** At the time of installation of the side wall horizontal vented gas fueled equipment, the installing plumber or gasfitter shall observe that a hard wired carbon monoxide detector with an alarm and battery back-up is installed on the floor level where the gas equipment is to be installed. In addition, the installing plumber or gasfitter shall observe that a battery operated or hard wired carbon monoxide detector with an alarm is installed on each additional level of the dwelling, building or structure served by the side wall horizontal vented gas fueled equipment. It shall be the responsibility of the property owner to secure the services of qualified licensed professionals for the installation of hard wired carbon monoxide detectors
 - A. In the event that the side wall horizontally vented gas fueled equipment is installed in a crawl space or an attic, the hard wired carbon monoxide detector with alarm and battery back-up may be installed on the next adjacent floor level.
 - B. In the event that the requirements of this subdivision can not be met at the time of completion of installation, the owner shall have a period of thirty (30) days to comply with the above requirements; provided, however, that during said thirty (30) day period, a battery operated carbon monoxide detector with an alarm shall be installed.
2. **APPROVED CARBON MONOXIDE DETECTORS.** Each carbon monoxide detector as required in accordance with the above provisions shall comply with NFPA 720 and be ANSI/UL 2034 listed and IAS certified.
3. **SIGNAGE.** A metal or plastic identification plate shall be permanently mounted to the exterior of the building at a minimum height of 8 ft above grade directly in line with the exhaust vent terminal for the horizontally vented gas fueled heating appliance or equipment. The sign shall read, in print size no less than one-half (1/2) inch in size, **"GAS VENT DIRECTLY BELOW. KEEP CLEAR OF ALL OBSTRUCTIONS."**
4. **INSPECTION.** The state or local gas inspector of the side wall horizontally vented gas fueled equipment shall not approve the installation unless, upon inspection, the inspector observes carbon monoxide detectors and signage installed in accordance with the provisions of 248 CMR 5.08(2)(a)1 through 4.

6.6 Warranty

Limited Warranty for SE+ Series Models

- Internal (Indoor) Models: CU199i and CU160i
- External (Outdoor) Models: CU199e and CU160e

What Is Covered?

The Rinnai Standard Limited Warranty covers any defects in materials or workmanship when the product is installed and operated according to Rinnai written installation instructions, subject to the terms within this Limited Warranty document. This Limited Warranty applies only to products that are installed correctly in the United States and Canada. Improper installation may void this Limited Warranty. In order for this warranty to apply, it is required that you use a trained and qualified professional who has attended a Rinnai installation training class before installing this water heater. This Limited Warranty coverage as set out in the table below extends to the original purchaser and subsequent owners, but only while the product remains at the site of the original installation. This Limited Warranty only extends to the first / original installation of the product and terminates if the product is moved or reinstalled at a new location.

Item	Warranty Coverage
Heat Exchanger*	8 Years
All Other Parts and Components	5 Years
Reasonable Labor	1 Year

*The heat exchanger warranty will be 8 years or 12,000 operation hours, whichever occurs first.

Notes:

- The integrated controller has a 1 year warranty on parts.

What Will Rinnai Do?

Rinnai will repair or replace the covered product or any part or component that is defective in materials or workmanship as set forth in the above table. Rinnai will pay reasonable labor charges associated with the repair or replacement of any such part or component during the term of the labor warranty period. All repair parts must be genuine Rinnai parts. All repairs or replacements must be performed by a licensed professional who is properly trained to do the type of repair.

Replacement of the product may be authorized by Rinnai only at its sole discretion. Rinnai does not authorize any person or company to assume for it any obligation or liability in connection with the replacement of the product. If Rinnai determines that repair of a product is not possible, Rinnai may replace the product with a comparable product at Rinnai's sole discretion. The warranty claim for product parts and labor may be denied if a component or product returned to Rinnai is found to be free of defects in material or workmanship; damaged by improper installation, use or operation; or damaged during return shipping.

How Do I Get Service?

You must contact a trained and qualified professional for the repair of a product under this Limited Warranty. For the name of a trained and qualified professional, please contact your place of purchase, visit the Rinnai website (www.rinnai.us), call Rinnai at 1-800-621-9419 or write to Rinnai at 103 International Drive, Peachtree City, Georgia 30269.

Proof of purchase is required to obtain warranty service. You may show proof of purchase with a dated sales receipt, or *by registering within 30 days of purchasing the product. To register your Rinnai Tankless Water Heater, please visit www.rinnai.us. For those without internet access, please call 1-866-RINNAI1 (746-6241). Receipt of Registration by Rinnai will constitute proof-of-purchase for this product. Registration of product installed in new home construction may be verified with a copy of the closing papers provided by the initial home buyer. However, Registration is not necessary in order to validate this Limited Warranty.*

What Is Not Covered?

This Limited Warranty does not cover any failures or operating difficulties due to the following:

- Accident, abuse, or misuse
- Alteration of the product or any component part
- Misapplication of this product
- Improper installation (such as but not limited to)
 - Product being installed in a corrosive environment
 - Condensate damage
 - Improper venting
 - Incorrect gas type
 - Incorrect gas or water pressure
 - Absence of a drain pan under the appliance
- Improper maintenance (such as but not limited to scale build-up, freeze damage, or vent blockage)
- Incorrect sizing
- Any other cause not due to defects in materials or workmanship
- Problems or damage due to fires, flooding, electrical surges, freezing or any acts of God
- Any damage caused by poor water quality
- Operating the water heater with anything other than potable water at all times
- Force majeure

There is no warranty coverage on product installed in a closed loop application, commonly associated with space heating only applications.

This Limited Warranty does not apply to any product whose serial number or manufacture date has been defaced.

This Limited Warranty does not cover any product used in an application that uses chemically treated water such as a pool or spa heater.

Limitation on Warranties

No one is authorized to make any other warranties on behalf of Rinnai America Corporation. Except as expressly provided herein, there are no other warranties, expressed or implied, including, but not limited to warranties of merchantability or fitness for a particular purpose, which extend beyond the description of the warranty herein.

Any implied warranties of merchantability and fitness arising under state law are limited in duration to the period of coverage provided by this Limited Warranty, unless the period provided by state law is less. Some states do not allow limitations on how long an implied Limited Warranty lasts, so the above limitation may not apply to you.

Rinnai shall not be liable for indirect, incidental, special, consequential or other similar damages that may arise, including lost profits, damage to person or property, loss of use, inconvenience, or liability arising from improper installation, service or use. Some states do not allow the exclusion or limitation of incidental or consequential damages, so the above limitation may not apply to you.

This Limited Warranty gives you specific legal rights, and you may also have other rights which vary from state to state.

www.rinnai.us/warranty



Learn more about Rinnai high-performance Tankless Water Heaters, Hybrid Water Heating Systems, Boilers, Vent-Free Fan Convectors and EnergySaver® Direct Vent Wall Furnaces at:

rinnai.us | rinnai.ca

Rinnai®

Rinnai America Corporation • 103 International Drive, Peachtree City, GA 30269
1-800-621-9419 • rinnai.us

©2018 Rinnai America Corporation. Rinnai America Corporation continually updates materials, and as such, content is subject to change without notice.

Local, state, provincial, federal and national fuel gas codes must be adhered to prior to and upon installation.

10000504(02)

11/2018