

Elm Trim Series

Elm Trim Series with TA-10 Flow Control Spindle & T-12A Cap Assembly  
**Installation & Operation Instructions**

**Model Numbers**

**TRIM ONLY**

**S-5500-TRM**  
Shower Valve Trim

**S-5501-TRM**  
Shower Trim

**S-5502-TRM**  
Tub/Shower Trim

**S-5504-TRM**  
Tub/Hand Shower Trim

**S5508TRM**  
Shower/Hand Shower Trim

**TRIM, TA-10, T-12A**

**S5500TRMTC**  
Shower Valve Trim

**S5501TRMTC**  
Shower Trim

**S5502TRMTC**  
Tub/Shower Trim

**S5504TRMTC**  
Tub/Hand Shower Trim

**S5508TRMTC**  
Shower/Hand Shower Trim

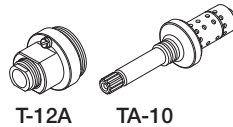

**Compliance**

- ASME A112.18.1/CSA B125.1



**Warranty**

**Limited Lifetime** - to the original end purchaser in consumer/residential installations.

**5 Years** - for industrial/commercial installations.

Refer to [www.symmons.com/warranty](http://www.symmons.com/warranty) for complete warranty information.

Go to [www.symmons.com/register](http://www.symmons.com/register) to register your Symmons product.



S-5500-TRM  
S5500TRMTC



S-5501-TRM  
S5501TRMTC



S-5502-TRM  
S5502TRMTC



S-5504-TRM  
S5504TRMTC

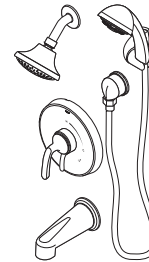

S5508TRM  
S5508TRMTC

## 1. Recommended Tools

FIGURE 1

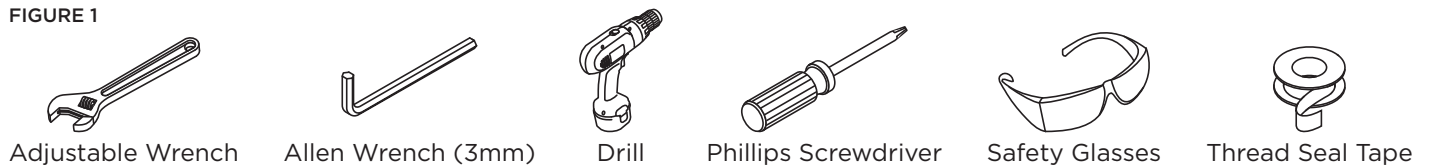

## 2. Dimensions

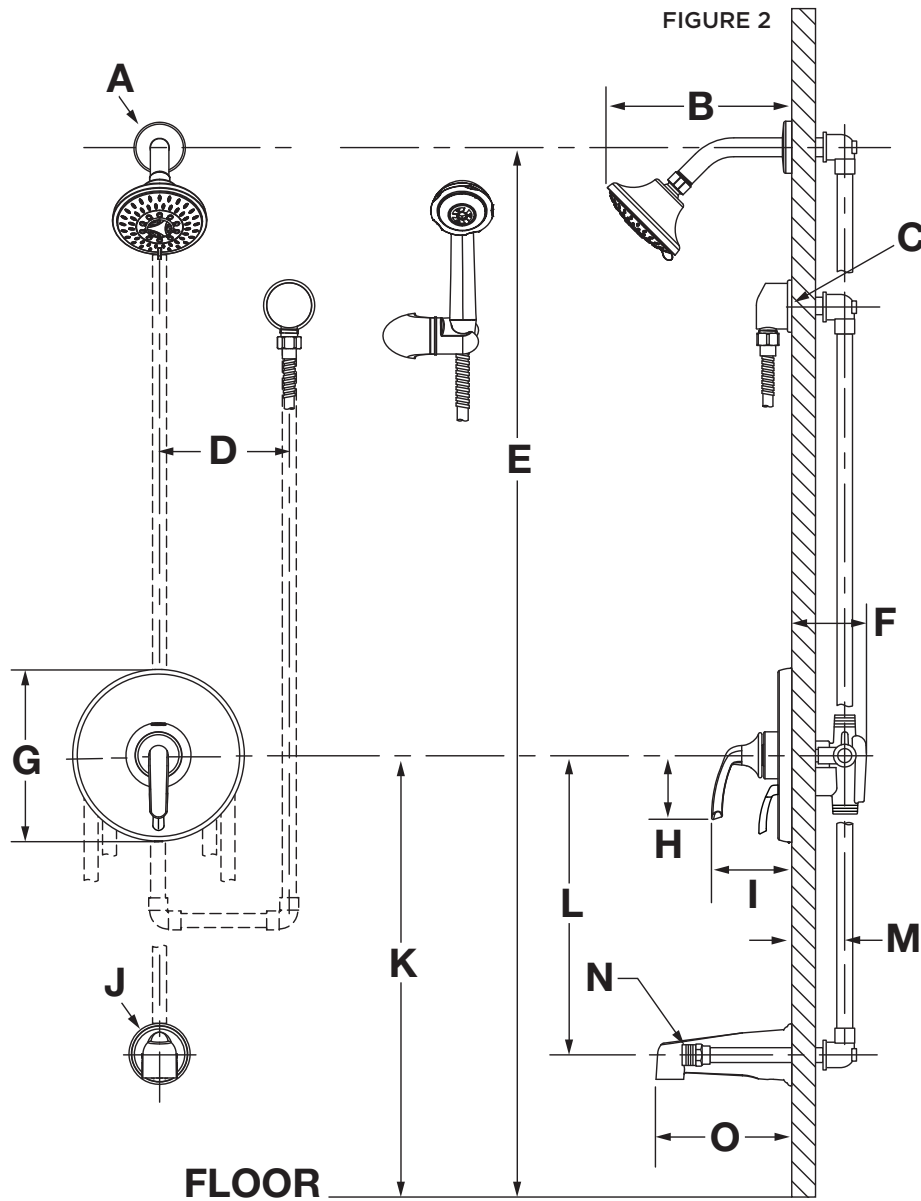

Measurements	
A	Ø 2-1/4", 57 mm
B	8", 203 mm
C	1/2" NPT thread must protrude 1/2" (13 mm) from finished wall
D	6", 152 mm
E	Ref. 77", 1956 mm
F	3-1/2", 89 mm
G	Ø 7-1/2", 191 mm
H	2-3/4", 70 mm
I	3-1/2", 89 mm
J	Ø 2-5/8", 67 mm
K	<b>Trim with tub spout:</b> Ref. 32", 813 mm <b>Trim without tub spout:</b> Ref. 42", 1067 mm
L	12", 305 mm
M	Rough-in 2-3/8" ± 1/2", 60 mm ± 13 mm
N	1/2" NPT thread must protrude 4-3/4" (121 mm) from finished wall
O	5-7/8", 149 mm

### Notes:

- 1) Valve body and piping not included and shown as reference only.
- 2) Plaster shield (p/n T-176) for dry wall, plaster or other type walls 1/2" or greater.
- 3) All dimensions measured from nominal rough-in (see M as reference).
- 4) Dimensions subject to change without notice.

### 3. Parts Breakdown (Model Numbers Ending in TRMTC)

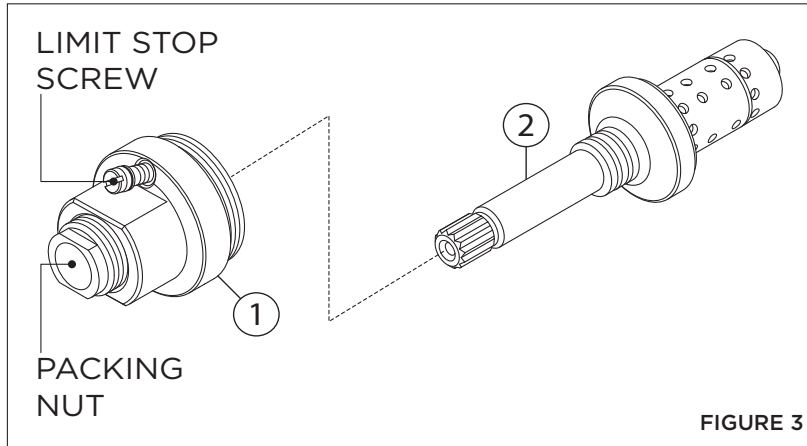

FIGURE 3

Replacement Parts		
Item	Description	Part Number
1	Cap Assy.	T-12A
2	Flow Control Spindle	TA-10

**IMPORTANT:** Model numbers ending in **TRMTC** coordinate with Temptrol pressure balancing valves ordered with Test Cap. The Test Cap is used to allow pressurization of system. **Do not** remove test cap from valve during wall construction, installation of valve or pressurization of system.

**⚠ WARNINGS:**

1. Test cap rated for pressure testing up to 200 psi maximum. **DO NOT** exceed 200 psi while pressure testing valve body.
2. Do not expose valve with test cap to heat for longer than 2 minutes when soldering copper tubing. Doing so may damage the internal components of the valve and will void the product warranty.
3. Ensure test cap is re-torqued to **30 lb-ft** after soldering valve body.

### 4. Installation - Remove Test Cap (Model Numbers Ending in TRMTC)

Flow control spindle (TA-10) and cap assembly (T-12A) will come factory assembled for all model numbers ending in **TRMTC**. When ready to remove Test Cap and install trim, follow the instructions below:

- 1) Check for leaks around the valve assembly and all pipe fittings.
- 2) Remove test cap from valve (FIGURE 4.1).
- 3) If system is dirty, flush valve.
- 4) Thread flow control spindle and cap assembly into valve body. Turn clockwise to secure to valve (FIGURE 4.2).

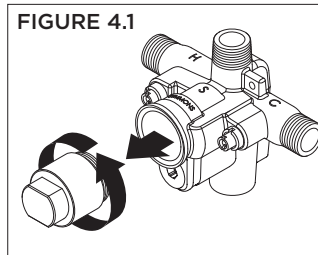

FIGURE 4.1

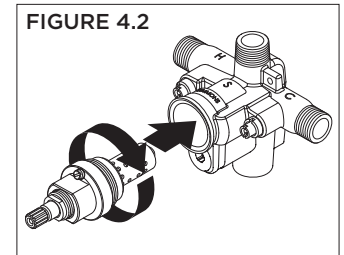

FIGURE 4.2

### 5. Installation - Adjust Packing Nut (Model Numbers Ending in TRMTC)

- 1) Turn hot and cold supplies on. Valve will not operate unless both hot and cold water supply pressures are on.
- 2) Place handle over flow control spindle.
- 3) Tighten packing nut for positive frictional resistance as handle is rotated from shut-off position across adjustment range.

### 6. Installation - Setting Limit Stop Screw (Model Numbers Ending in TRMTC)

The temperature limit stop screw limits valve handle from being turned to maximum position resulting in excessive hot water discharge temperatures.

**⚠ WARNING:** Failure to adjust limit stop screw properly may result in serious scalding.

- 1) Turn hot and cold supplies on. Valve will not operate unless both hot and cold water supply pressures are on.
- 2) Place handle on flow control spindle and open valve to maximum desired temperature.
- 3) Turn limit stop screw clockwise until it seats.

## 7. Parts Breakdown

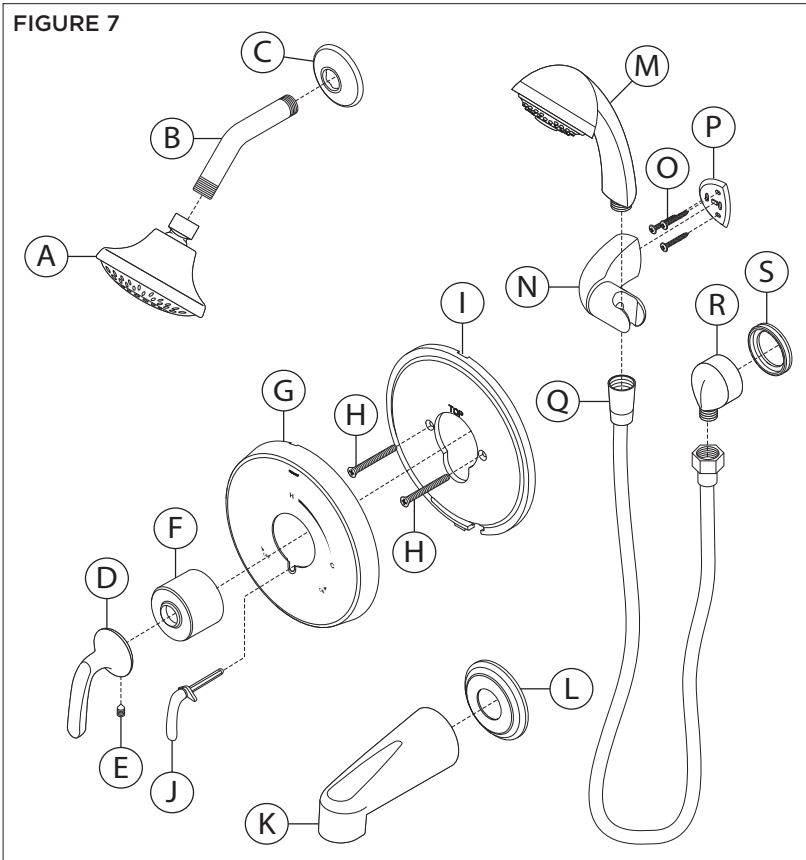

\*Order in-line vacuum breaker (EF-109) for hand shower systems without dual checks.

Replacement Parts		
Item	Description	Part Number
A	Showerhead	552SH
B	Shower Arm	
C	Flange	300S
D	Shower Handle	
E	Set Screw	RTS-006
F	Dome Cover	T-19
G	Shower Escutcheon	
H	Screws	T-631A-NS-K002
I	Mounting Plate	
J	Diverter/Volume Control Handle	RTS-008
K	Tub Spout Escutcheon	552TS
L		
M	Hand Shower	552W
N	Wall Cradle	
O	Screws	EF-106
P	Mounting Plate	
Q	60" Hose	RO-005
R	Wall Elbow	
S	Escutcheon	RO-004

### Notes:

- 1) Append appropriate suffix for premium finish.
- 2) Append appropriate flow rate to showerhead or hand shower for low flow.
- 3) Apply a bead of silicone around the perimeter of all shower trim installed flush to the finished wall. Leave opening on bottom of escutcheons for weep hole.
- 4) Apply plumber tape to all threaded connections.

## 8. Installation - Shower Valve Trim

- 1) Secure large mounting plate to Temptrol pressure balancing valve using mounting screws (FIGURE 8.1).
- 2) Place diverter/volume control handle into slot in shower escutcheon (FIGURE 8.2).
- 3) Secure large shower escutcheon to mounting plate. Guide handle into control port on valve body. Tabs should snap in place (FIGURE 8.3).
- 4) Install dome cover by turning clockwise (FIGURE 8.4).
- 5) Install handle to shower valve. Secure with set screw (FIGURE 8.5).

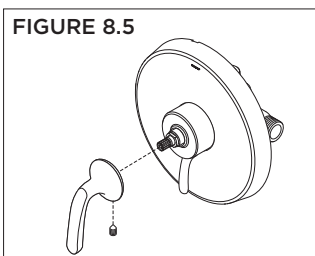
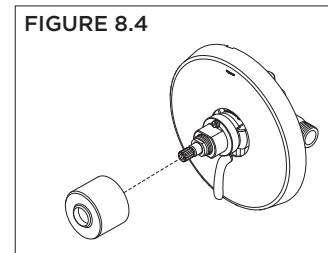
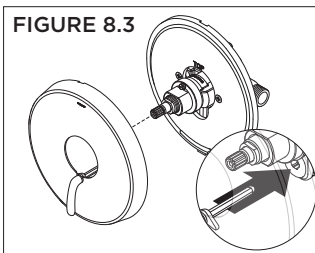
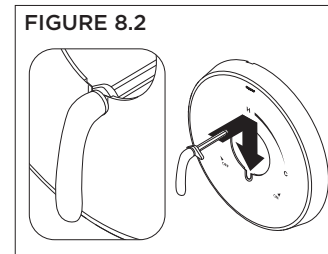
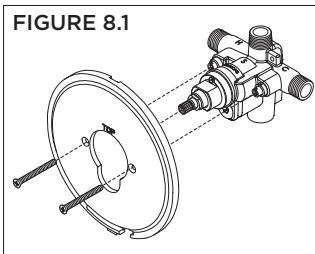

## 9. Installation - Showerhead & Tub Spout

- 1) Attach arm and flange to shower pipe. Turn clockwise to tighten (FIGURE 9.1).
- 2) Install showerhead to shower arm. Turn clockwise to tighten (FIGURE 9.2).
- 3) Install tub spout escutcheon and tub spout to stub out pipe. Turn clockwise to tighten (FIGURE 9.3).

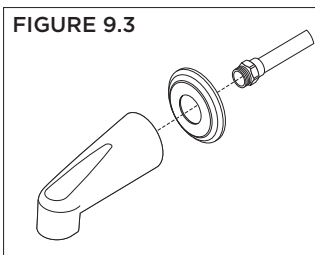
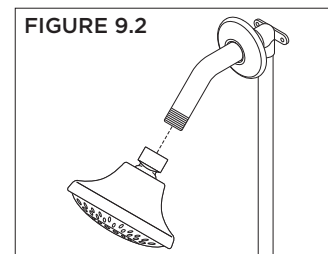
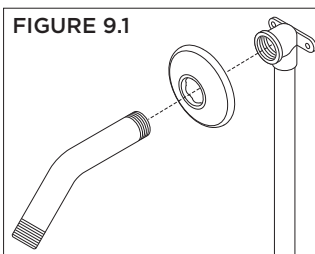

## 10. Installation - Slide Bar Assembly

- 1) Place mounting plate in position. Mark and drill  $3/16''$  holes for tile anchors,  $5/16''$  holes for drywall anchors. Install anchors (FIGURE 10.1).  
**Note:** For dry wall  $1/2''$  thick or less, insert anchor tool into drywall anchor to secure behind wall prior to installing wall cradle.
- 2) Remove cover of hand shower cradle. Install cradle and mounting plate. Secure with three screws. Replace cover on hand shower cradle (FIGURE 10.2).
- 3) Install wall elbow escutcheon and wall elbow to stub out pipe. Tighten set screw to secure (FIGURE 10.3).
- 4) Attach small end of hand shower hose to wall elbow. Turn clockwise to tighten (FIGURE 10.4).
- 5) Attach large end of hand shower hose to hand shower wand. Turn clockwise to tighten (FIGURE 10.5).

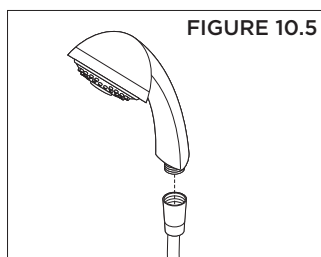
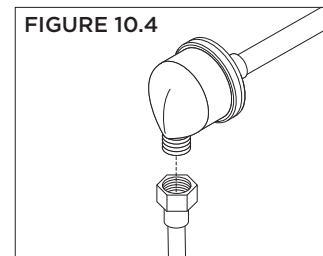
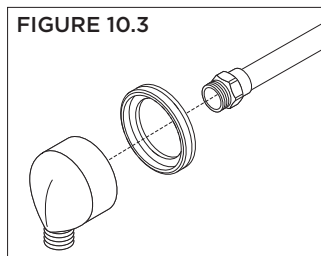
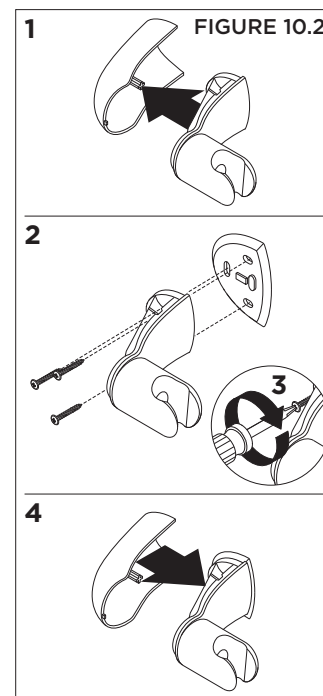
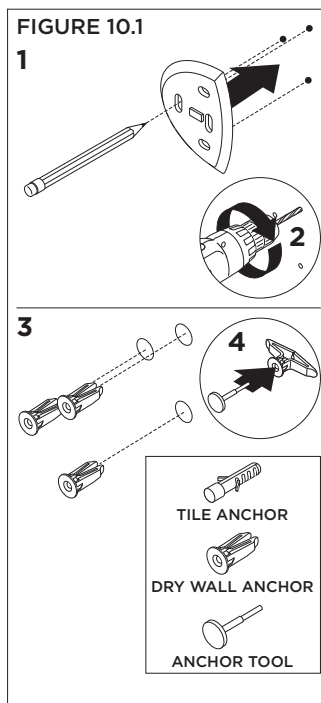

---

## 11. Operation (Temperature Control)

---

- 1) Turn shower handle counter-clockwise approximately 1/4 turn to put valve in cold position (FIGURE 11.1).
- 2) Turn shower handle counter-clockwise approximately 1/2 turn to put valve in warm position (FIGURE 11.2).
- 3) Turn shower handle counter-clockwise approximately 3/4 turn to put valve in hot position (FIGURE 11.3).

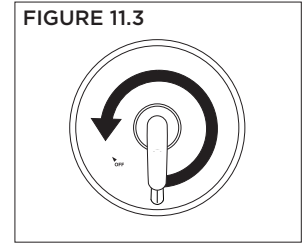
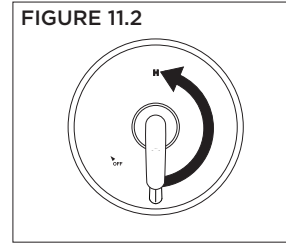
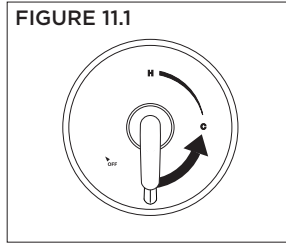

---

## 12. Operation (VersaFlex™ Diverter Control)

---

Turn diverter control handle clockwise to divert to **tub spout** or other Symmons **accessory**.

Turn diverter control handle counterclockwise to divert to **shower** or other Symmons **accessory**.

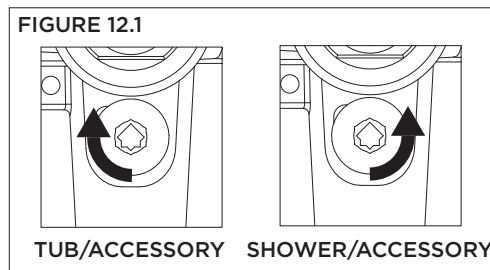

---

## 13. Operation (Volume Control)

---

Turn volume control handle clockwise to **increase** volume.

Turn volume control handle counterclockwise to **decrease** volume.

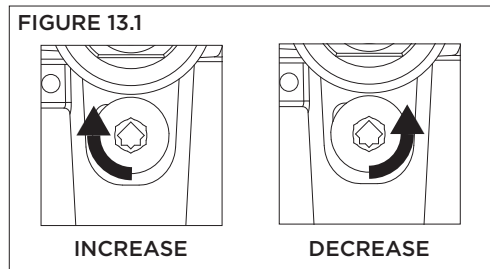

---

## 14. Troubleshooting Chart

---

Problem	Cause	Solution
Finish is spotting.	Elements in water supply may cause water staining on finish.	Clean finished trim area with a soft cloth using mild soap and water or a non-abrasive cleaner and then quickly rinse with water.

 **WARNING:** This product can expose you to chemicals including lead, which is known to the state of California to cause cancer, birth defects, or other reproductive harm. For more information, go to [www.P65Warnings.ca.gov](http://www.P65Warnings.ca.gov).