



Uponor

RADIANT HEATING
SYSTEMS

**QUIK TRAK® DESIGN AND
INSTALLATION MANUAL**

**Quik Trak® Design and
Installation Manual**

Table of Contents

Uponor Quik Trak®	1
Quik Trak Calculations.....	2
Installation Methods.....	3
Quik Trak Over a Wood Subfloor with Hardwood Floor Covering	3
Quik Trak Over a Wood Subfloor with Tile/Linoleum Floor Covering	4
Quik Trak Over a Wood Subfloor with Carpet Floor Covering	5
Quik Trak Over an Existing Concrete Slab	6
Quik Trak Radiant Wall Installation.....	7
Quik Trak Design and Installation.....	8
Planning the Quik Trak Installation	8
Piping Layout When Running Tubing Above the Floor.....	9
Piping Layout with Access from Below the Floor	10
Panel Direction	11
Preliminary Layout.....	12
Panel Installation	12
Installing Return Panels	13
Final Floor Preparation	14
Tubing Installation	14
Pressure Testing	15
Appendix A — Advanced Design Suite™ (ADS) Worksheet	16
Appendix B — Quik Trak Design Worksheet.....	17
Appendix C — Radiant Surface Temperature Charts	18
Appendix D — R-value Charts.....	19
Appendix E — Supply Water Temperature Charts	20
Appendix F — Flow Chart	21
Appendix G — Hydronic Friction Loss Table	22

Quik Trak® Design and Installation Manual is published by

Uponor, Inc.

5925 148th Street West
Apple Valley, MN 55124 USA
Tel: 800.321.4739
Fax: 952.891.2008
www.uponorpro.com

Uponor Ltd.

2000 Argenta Rd., Plaza 1, Ste. 200
Mississauga, ON L5N 1W1 CANADA
Tel: 888.994.7726
Fax: 800.638.9517
www.uponorpro.com

© 2013 Uponor Inc., All rights reserved.

Third Edition June 2013

First Printing September 2000

Printed in the United States of America

Uponor has used reasonable efforts in collecting, preparing and providing quality information and material in this manual. However, system enhancements may result in modification of features or specifications without notice.

Uponor is not liable for installation practices that deviate from this manual or are not acceptable practices within the mechanical trades.

Uponor Quik Trak

Uponor makes it easier to keep up with the demand for radiant heating with Quik Trak. This cost-effective, patented, wood-panel system is engineered for wood-frame construction and offers an alternative to joist heating and poured floor underlayment installations. Only ½" thick, Quik Trak adds minimal height to floors.

Fast, Easy Installation

Uponor's Quik Trak system provides fast, easy and trouble-free installation of radiant heating in retrofit, remodeling and new construction projects. The system incorporates ¾" Wirsbo hePEX™ tubing into the panel. Quik Trak panels are designed with a center groove that provides a tight fit for the ¾" Wirsbo hePEX tubing. In many installations, the low profile of the panels require only a ½" alteration of the finished floors, doors and entryways.

Quik Trak is easily installed in many types of floor construction:

- Over a suspended wood subfloor
- Over an existing concrete slab
- In wall or ceiling installations

Quik Trak Installation Tools:

- 12" power miter box, slide-cut saw, table saw or circular saw with ripping guide (use new or sharp carbide blade)
- Cordless or corded drill with several quality #2 Phillips bits and/or #2 square-drive bits and a ⅝" wood bit
- Jig saw or reciprocating saw and wood cutting blades
- Tape measure
- Square
- Hammer
- Rubber mallet
- ¾" wood chisel
- Chalk line



Figure 1: Quik Trak Panel

- Straight tin snips
 - Shop vacuum
 - Extension cord
 - Safety glasses
 - PEX tubing cutter (E6081125, E6081128, E6081501)
 - Air compressor/air chuck for air testing and powering pneumatic tools
 - 100% Silicone Sealant or Quik Trak Sealant (E6050010) (recommended)
 - Caulk gun for 10.1 oz. tubes
- Note:** A pneumatic or cordless caulk gun work well for this application.
- Tubing uncoiler (E6061000, E6062000, E6063000) (recommended)
 - Router with ½" cutting blade (recommended)
 - Quik Trak Installation Tool Kit (E6050000) with Quik Trak Screws (E6051250) (recommended)



Figure 2: Quik Trak Installation Kit (E6050000)

Important! Take the time to carefully plan the layout of your Quik Trak design prior to installation. It will save you considerable labor costs on your first project.

Prepping the Panel Area

Ensure the subfloor is clean and free of movement and high spots.

Note: Since Quik Trak panels are considered an underlayment, the subfloor must be rated to carry the load of the structure without including the ½" Quik Trak panels. Make sure all areas that will not have panels (e.g., cabinets, built-ins) are outlined in some way.

Fill all areas that won't get panels with ½" plywood or other materials. These areas should be left open until the Quik Trak System goes down. This can easily be handled by the carpentry contractor or the radiant installer. Have some ½" plywood on hand for any custom tubing adjustments that may happen due to field changes.



Figure 3: Quik Trak Return Panel

Quik Trak Calculations

Uponor's Advanced Design Suite™ (ADS) software performs heat-loss calculations, guides the system designer through the radiant panel design, provides system requirements and generates a material list. This powerful design tool also offers the contractor a host of business tools for a variety of job-management functions.

The calculation portion of ADS prompts the user to input the tubing type, the design differential temperature and the specifics of floor construction. ADS analyzes the information and calculates a supply water temperature and the amount of tubing and number of panels for the room. The user assigns each room or area to a manifold. The program then calculates loop lengths, flow and feet of head.

If you do not have ADS, perform a room-by-room heat loss. From the heat loss information, divide the BTU/h load per room by the available net floor area (i.e., area that will have installed panels) to determine the BTU/h load per square foot of net floor space.

$$\frac{\text{BTU/h/Room}}{\text{Net Floor Area (paneled)}} = \text{BTU/h/ft}^2$$

See the design sheet in **Appendix B** for calculation assistance.

When designing the system, Uponor recommends surface temperatures not exceed 80°F (26.7°C) for a solid wood floor and 87.5°F (30.8°C) for any other floor surface.

Note: If the BTU/h/ft² load exceeds the BTU/h output of the Quik Trak panels or recommended surface temperature, supplemental heat is required. Uponor's ADS will give you this information. You can deliver supplemental heat to a specific area by using radiant wall or ceiling, baseboard, radiators or hot-water convectors.

Panel Calculations

To determine the number of Quik Trak and Return Panels, use the following formulas:

Net Floor Area x 0.386 =
Number of Quik Trak panels (round up to the next whole number)

Net Floor Area x 0.043 =
Number of Return Panels (round up to the next whole number)

Example

Given a 375-square-foot room,
375 x 0.386 = 145 Quik Trak panels needed
375 x 0.043 = 16 Return Panels needed

Tubing Calculations

To calculate the amount of tubing needed, multiply the net floor area by 1.7. Divide the total amount of tubing into equal lengths that are less than 250 ft. including the leader length for the loop. Leader length is the distance from the manifold to the

room and back to the manifold plus the vertical distance from the floor to the manifold.

Note: The leader length is doubled to account for supply and return runs.

Example

Given a 375-square-foot room with a leader length of 15 ft. between the room and the manifold location, calculate the number of loops required and the average loop length.

375 square ft. x 1.7 = 638 linear ft.

638 ÷ 3 = 213 ft. average active loop length

15 ft. (leader length) x 2 = 30 ft.

213 + 30 = 243 ft. total loop length

The room will require 3 loops of 243 ft.

The design sheet in **Appendix B** will help with the process.

Note: Do not exceed 250 ft. for the total loop length.



Figure 4: Installing Quik Trak Panels

Installation Methods

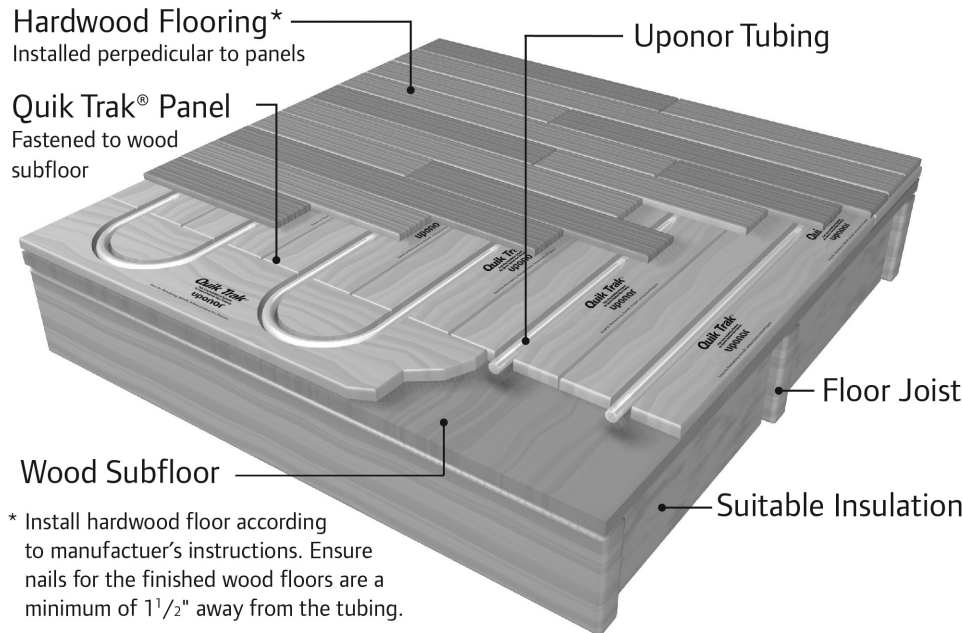

Quik Trak Over a Wood Subfloor with Hardwood Floor Covering

How — Lay Quik Trak panels over a plywood subfloor perpendicular to the finished wood floor. Make sure to stagger the seams of the Quik Trak.

Secure panels to the subfloor with 1¼" Quik Trak Screws or 1" staples. To start, secure the middle of the panel with a screw or staple. Work from the middle to the ends, alternating from side to side.

After laying the panels, vacuum the debris from the panel grooves. Next, apply a thin, ⅛" bead of 100% silicone sealant throughout the entire length of the groove. The sealant acts as an adhesive agent and promotes good heat transfer from the tubing to the panel.

Install the tubing by stepping the tubing into the panel grooves. If you're not wearing hard-sole shoes, you may need to use a rubber hammer to snap the tubing into the groove.

Where — This application is used in residential construction as an alternative to joist heating and poured-floor underlayment installations. Quik Trak is also beneficial when the finished floor material is hardwood. Installers can actually see the tubing when installing the hardwood floor. This method offers several advantages, including minimal increase in floor height, no moisture from concrete and increased BTU/h/ft² output potential over joist heating.

What to look for — Take special care when installing hardwood flooring over radiant floors. Please consult **Chapter 16 from the Complete Design Assistance Manual (CDAM)** for detailed wood floor information.

Always install hardwood floors in accordance with the flooring manufacturer's instructions. Ensure nails for the finished wood floor are a minimum of 1½ inches away from the tubing.

Note: Do not exceed 80°F (26.7°C) for hardwood floor surface temperatures.

Proper insulation is critical to the performance of Quik Trak. A minimum of R-19 is recommended in between the floor joists beneath the floor.

In all Quik Trak applications, the maximum loop length for ⅝" Wirsbo hePEX tubing is 250 ft., including leader lengths. Flow rates for all Quik Trak installations are calculated to a 20°F (11.1°C) temperature differential.

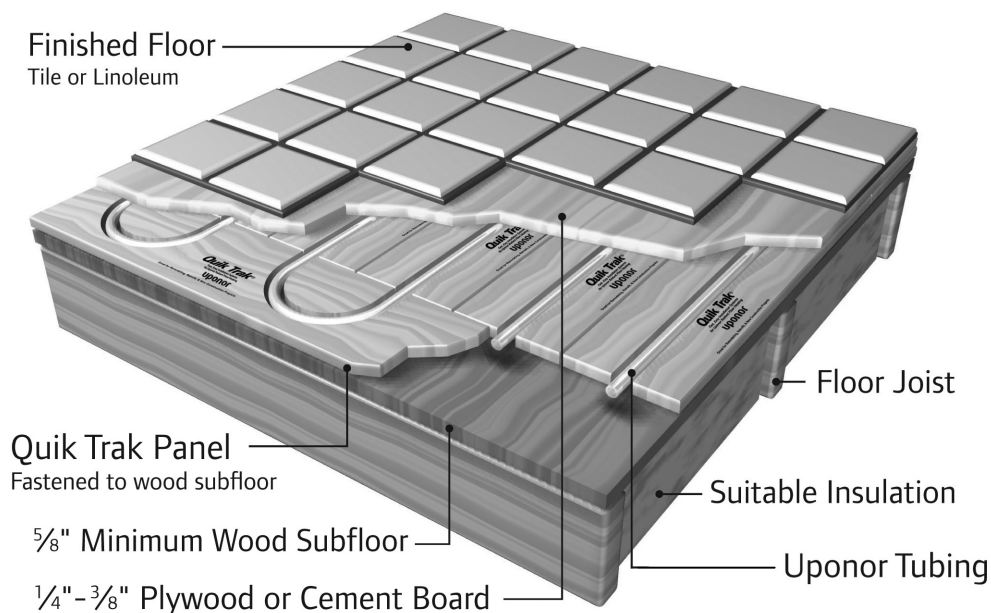

Quik Trak Over a Wood Subfloor with Tile/Linoleum Floor Covering

How — Lay Quik Trak panels over a plywood subfloor perpendicular to the floor joists. Make sure to stagger the seams of the Quik Trak.

Secure panels to the subfloor with 1 1/4" Quik Trak Screws or 1" staples. To start, secure the middle of the panel with a screw or staple. Work from the middle to the ends, alternating from side to side.

After laying the panels, vacuum the debris from the panel grooves. Next, apply a thin, 1/8" bead of 100% silicone sealant throughout the entire length of the groove. The sealant acts as an adhesive agent and promotes good heat transfer from the tubing to the panel.

Install the tubing by stepping the tubing into the panel grooves. If you're not wearing hard-sole shoes, you may need to use a rubber hammer to snap the tubing into the groove.

Where — This application is used in residential construction as an alternative to joist heating and poured-floor underlayment installations. Quik Trak is also beneficial when the finished floor material is hardwood. Installers can actually see the tubing when installing the hardwood floor. This method offers several advantages, including minimal increase in floor height, no moisture from concrete and increased BTU/h/ft² output potential over joist heating.

What to look for — Proper insulation is critical to the performance of Quik Trak. A minimum of R-19 is recommended in between the floor joists beneath the floor.

Note: Do not exceed 87.5°F (30.8°C) for tile and linoleum floor surface temperatures.

In all Quik Trak applications, the maximum loop length for 5/16" Wirsbo hePEX tubing is 250 ft., including leader lengths. Flow rates for all Quik Trak installations are calculated to a 20°F (11.1°C) temperature differential.

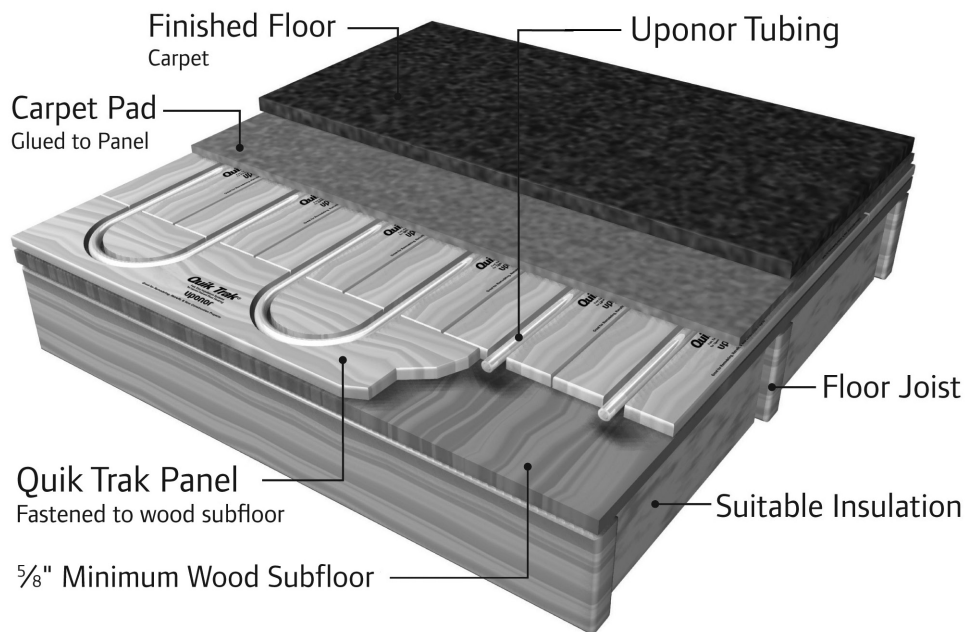

Quik Trak Over a Wood Subfloor with Carpet Floor Covering

How — Lay Quik Trak panels over a plywood subfloor perpendicular to the floor joists. Make sure to stagger the seams of the Quik Trak.

Note: For carpet installations, it is necessary to install 6" of plywood material around the perimeter of the room to allow space to install the tack strip and padding.

Secure panels to the subfloor with 1¼" Quik Trak Screws or 1" staples. To start, secure the middle of the panel with a screw or staple. Work from the middle to the ends, alternating from side to side.

After laying the panels, vacuum the debris from the panel grooves. Next, apply a thin, ⅛" bead of 100% silicone sealant throughout the entire length of the groove. The sealant acts as an adhesive agent and promotes good heat transfer from the tubing to the panel.

Install the tubing by stepping the tubing into the panel grooves. If you're not wearing hard-sole shoes, you may need to use a rubber hammer to snap the tubing into the groove.

Where — This application is used in residential construction as an alternative to joist heating and poured-floor underlayment installations. Quik Trak is also beneficial when the finished floor material is hardwood. Installers can actually see the tubing when installing the hardwood floor. This method offers several advantages, including minimal increase in floor height, no moisture from concrete and increased BTU/h/ft² output potential over joist heating.

What to look for — Proper insulation is critical to the performance of Quik Trak. A minimum of R-19 is recommended in between the floor joists beneath the floor.

Note: Do not exceed 87.5°F (30.8°C) for carpeted floor surface temperatures.

In all Quik Trak applications, the maximum loop length for ⅝" Wirsbo hePEX tubing is 250 ft., including leader lengths. Flow rates for all Quik Trak installations are calculated to a 20°F (11.1°C) temperature differential.

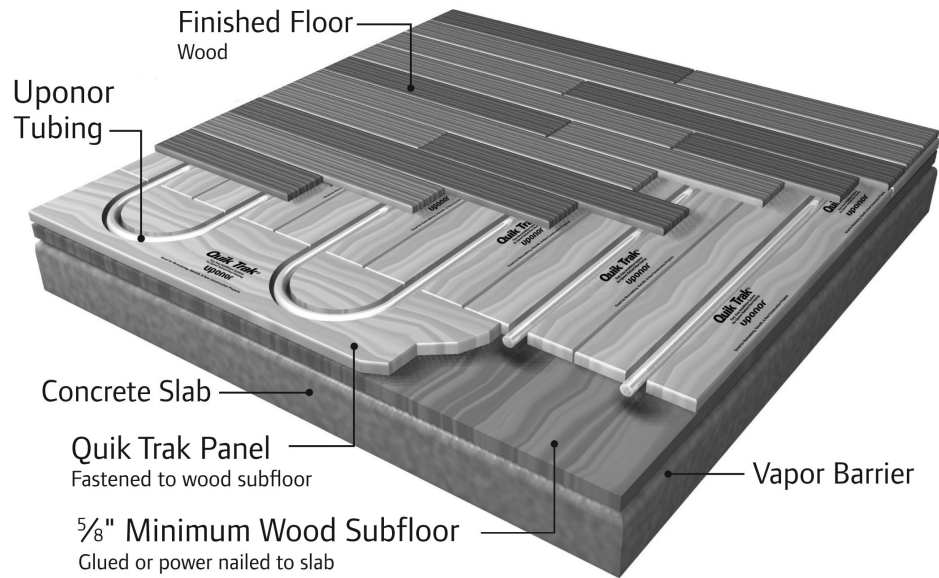

Quik Trak Over an Existing Concrete Slab

How — First, install a layer of $\frac{5}{8}$ " or $\frac{3}{4}$ " plywood subfloor over the concrete slab. Glue or power-nail the plywood directly to the concrete if a vapor barrier is not required. If a vapor barrier is required, then power-nail the plywood to the concrete slab.

Lay Quik Trak panels over the plywood subfloor. Make sure to stagger the seams of the Quik Trak.

Secure the panels to the subfloor with 1" screws or 1" staples. To start, secure the middle of the panel with a screw or staple. Work from the middle to the ends, alternating from side to side.

After laying the panels, vacuum the debris from the panel grooves. Next, apply a thin, $\frac{1}{8}$ " bead of 100% silicone sealant throughout the entire length of the groove. The sealant acts as an adhesive agent and promotes good heat transfer from the tubing to the panel.

Install the tubing by stepping the tubing into the panel grooves. If you're not wearing hard-sole shoes, you may need to use a rubber hammer to snap the tubing into the groove.

Where — This application is used in residential construction over existing concrete slabs. The plywood base together with the Quik Trak panel only adds $1\frac{1}{8}$ " to $1\frac{1}{4}$ " in floor height. It is the ideal solution when retrofitting or remodeling a basement.

What to look for — A high water table will adversely affect the performance of this application. If there is moisture present that cannot be eliminated from the area, do not use this application.

Note: In a basement or walkout application, it is very important to install perimeter and edge insulation for proper design performance.

In all Quik Trak applications, the maximum loop length for $\frac{5}{16}$ " Wirbo hePEX tubing is 250 ft., including leader lengths. Flow rates for all Quik Trak installations are calculated to a 20°F (11.1°C) temperature differential.

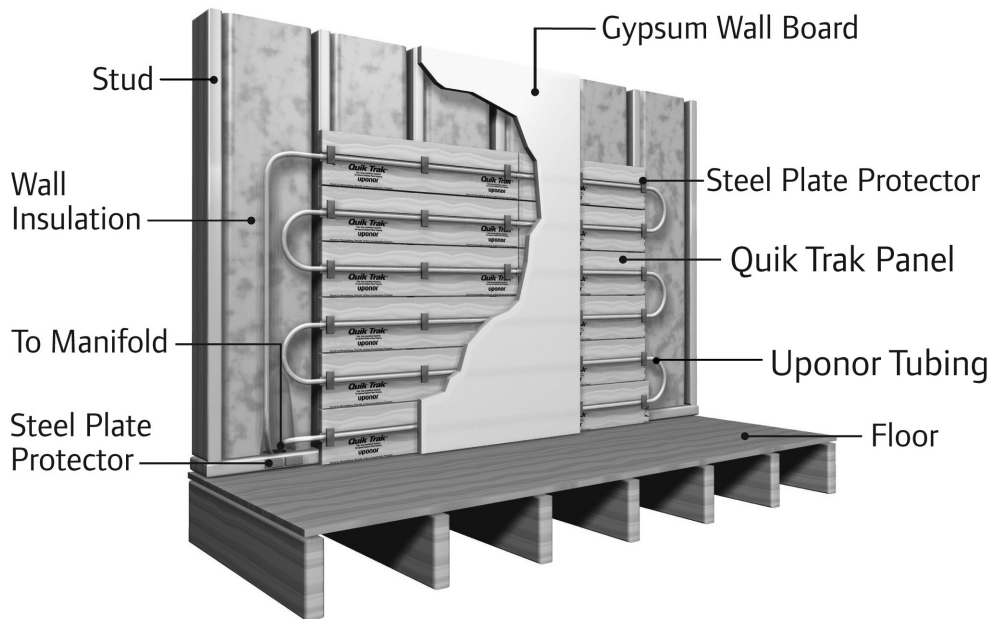

Quik Trak Radiant Wall Installation

How — Starting at the floor level on the outside wall, install Quik Trak panels parallel to the floor at a maximum of six rows high (42") to avoid interference with window and picture placement. Fasten panels to the studs on both sides of the groove with 1" drywall screws. After installing the panels, attach ½" furring strips to the remainder of the stud wall, to provide an even base for the sheetrock.

To install the tubing, drill two ⅝" holes in the footer plate opposite the tubing return. Feed the supply through the ⅝" hole and attach to the supply manifold. Vacuum the grooves. Apply a thin, ⅛" bead of 100% silicone sealant into the grooves. Firmly press tubing into the groove. Feed return to the second ⅝" hole and attach to the return manifold. Lastly, attach protector plates (strike plates) where the tubing crosses the studs to protect the tubing from puncture.

Where — Radiant wall installations are a low-cost alternative to radiant floor heating and are often installed when radiant floor is not viable. This method is routinely used in retrofit applications. In addition, radiant wall installations are most often used in supplemental heat situations when the radiant floor cannot satisfy the heat loss of a room under design conditions.

What to look for — Do not install tubing in an area where pictures may be hung.

Ensure the supply loop feeds from the top of the panel and works its way to the bottom. This will help eliminate the possibility of air lock in the loop.

Install a minimum of R-19 insulation in the exterior wall behind the Quik Trak panels.

In all Quik Trak applications, the maximum loop length for ⅝" Wirsbo hePEX tubing is 250 ft., including leader lengths. Flow rates for all Quik Trak installations are calculated to a 20°F (11.1°C) temperature differential.

Quik Trak Design and Installation

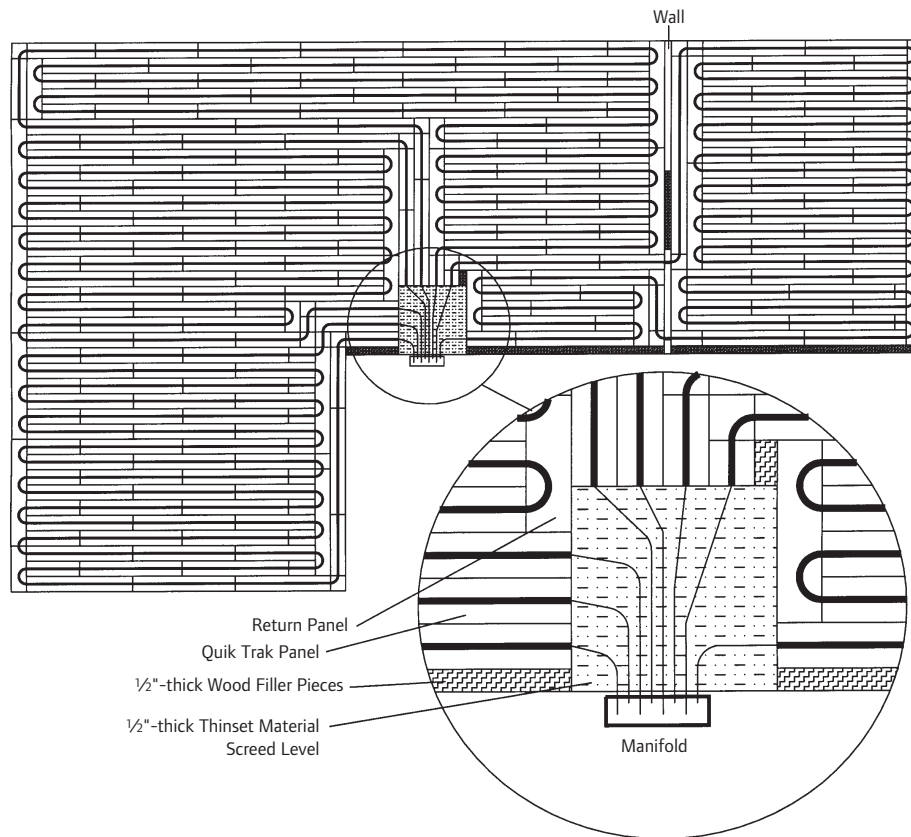

Planning the Quik Trak Installation

In a concrete application, you can improve installation time by carefully planning the placement of manifolds and leaders. As shown above, the leaders must run above the floor.

To save time, draw the Quik Trak layout on a piece of paper before you begin the installation.

1. Split the areas that will have panels into even areas based on the number of loops. The number of loops can be determined by using the Design Assistance Sheet in **Appendix B** or your Uponor ADS program.
2. Select the manifold location.
3. For 7" panels, draw a 28" square in front of the manifold location. The manifold location is the area that will contain the tightly spaced tubing running from the manifold to the panels. This area may be larger or smaller depending upon the number of loops.
4. To begin the panel installation, measure the distance from the outside wall back to the manifold wall. Divide by 0.583 to determine the number of panel rows needed. Any remaining areas less than the width of a panel can be filled with $\frac{1}{2}$ " plywood.
5. Place the panels that will be used for the leaders. Do not fasten them down at this time.
6. Place the Quik Trak and Return Panels to determine the overall placement.
When the panels are in place, fasten the panels using only two screws. This will allow for quick adjustments if needed. Once the layout has been completed, fasten panels with 10 screws.
7. Fill in any small areas that do not have panels with $\frac{1}{2}$ " plywood.
8. When installing the tubing, use staples or U-shaped tube fasteners to hold the tubing down in the area in front of the manifold.
9. After connecting the tubing to the manifold and pressure testing the system, fill in the square area in front of the manifold using $\frac{1}{2}$ " plywood (trimmed to fit) or a cement product that is screed to a level surface.

Note: A combination is also possible. Fill the larger spaces with $\frac{1}{2}$ " plywood pieces and smaller areas with a thinsset product. The type of finished flooring will dictate what method is appropriate.

Piping Layout When Running Tubing Above the Floor

Carefully plan the Quik Trak layout before installation begins. A well-planned layout will result in equal loop lengths and minimal waste. Placement of the manifold is key to determining the layout. Manifolds can be placed either above or below the floor. Either location needs to be accessible by a service panel if the wall or ceiling below are finished.

Figures 5 and 6 show manifold location in the wall because the floor is inaccessible from below (e.g., over a concrete slab).

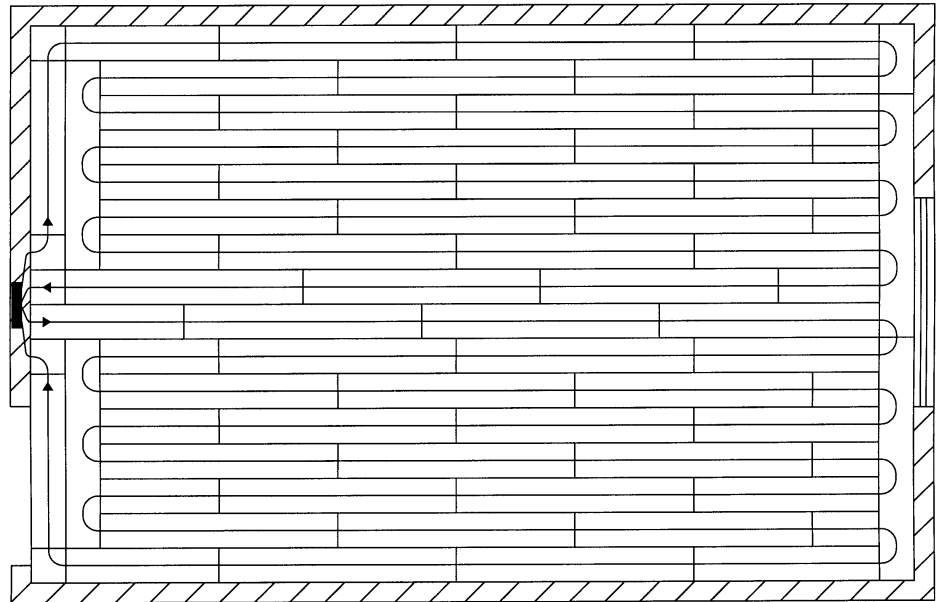

Figure 5: Manifold Location in the Wall

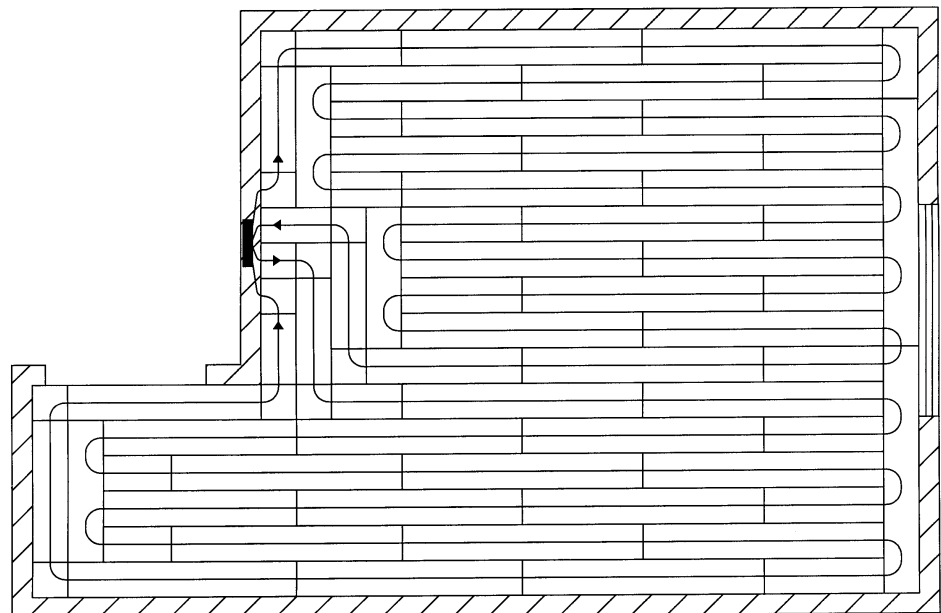

Figure 6: Manifold Location in the Wall

Piping Layout with Access from Below the Floor

Figures 7 and 8 show manifold locations in the joist cavity. The entire floor area is accessible.

The arrows illustrate the direction of water flow through the tubing. The dotted lines represent the supply and return lines that are beneath the floor.

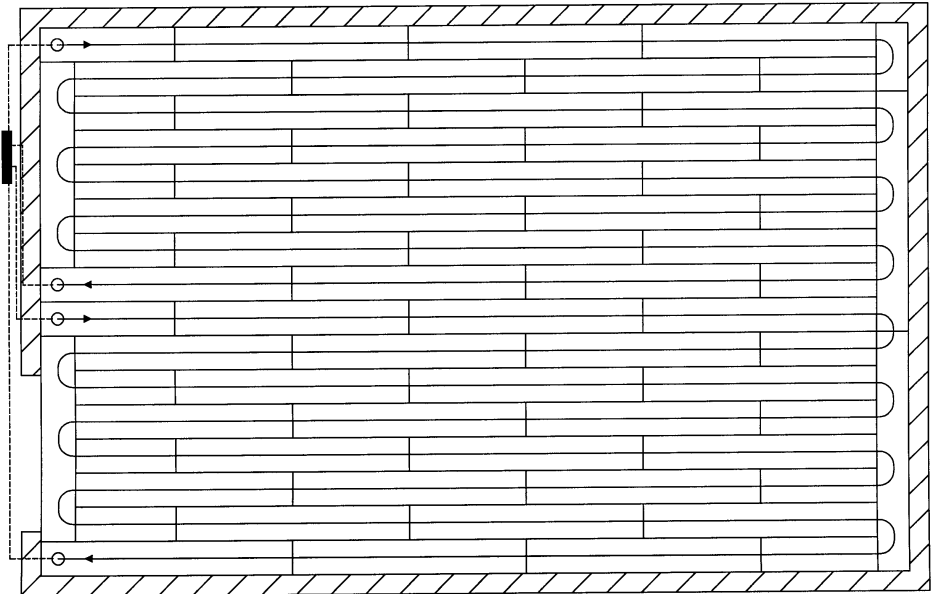

Figure 7: Manifold Location in the Joist Cavity

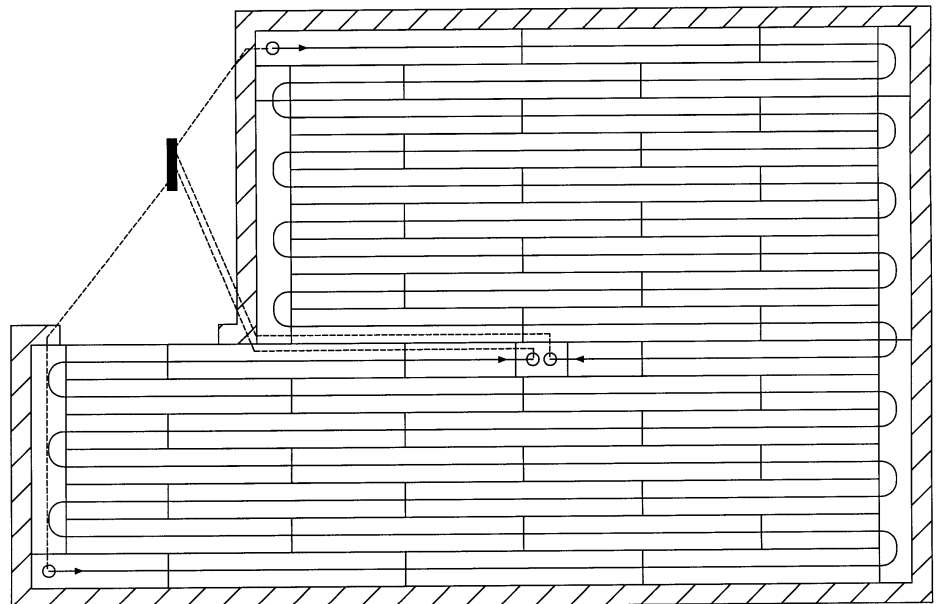

Figure 8: Manifold Location in the Joist Cavity

Panel Direction

When possible, start with the warmest water on the exterior walls and progress toward the interior of the room. The direction of the panels in the layout dictate the tubing runs.

Figures 9, 10 and 11 show the recommended layout for the panels. The arrows represent the recommended direction of the Quik Trak panels.

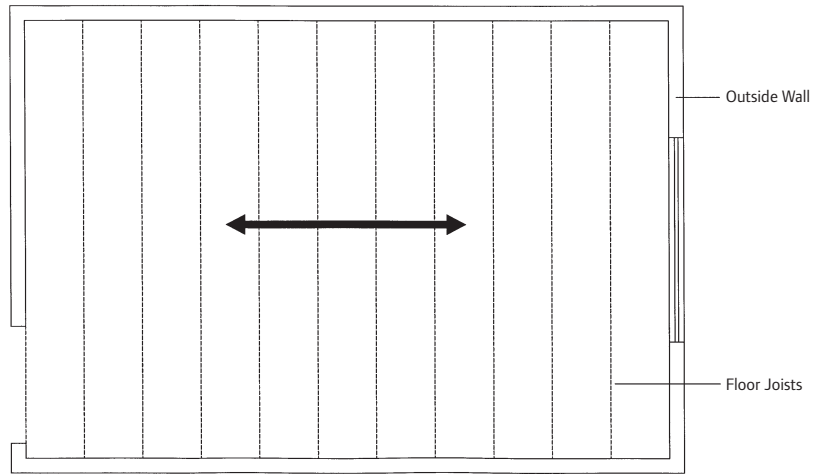

Figure 9: For tile, parquet and linoleum finished floors, install Quik Trak panels perpendicular to the floor joists. This will add strength to the floor and help prevent deflection of the floor.

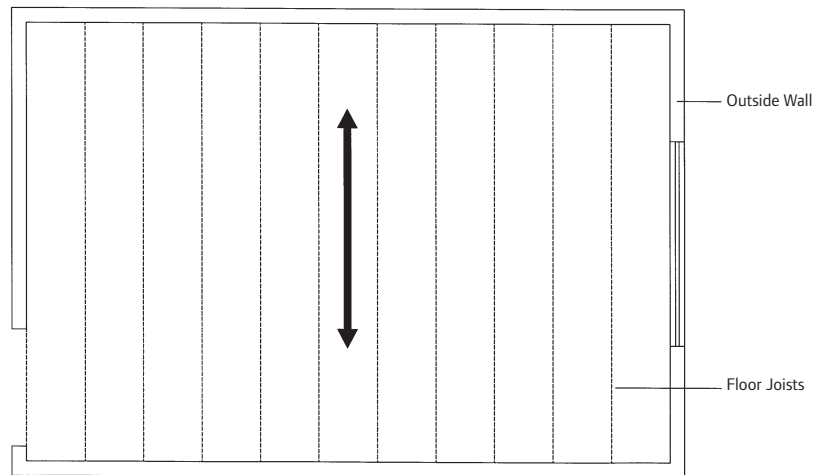

Figure 10: For carpeted floors, install Quik Trak panels parallel to the exterior wall to allow the warmest water to reach the coldest area first.

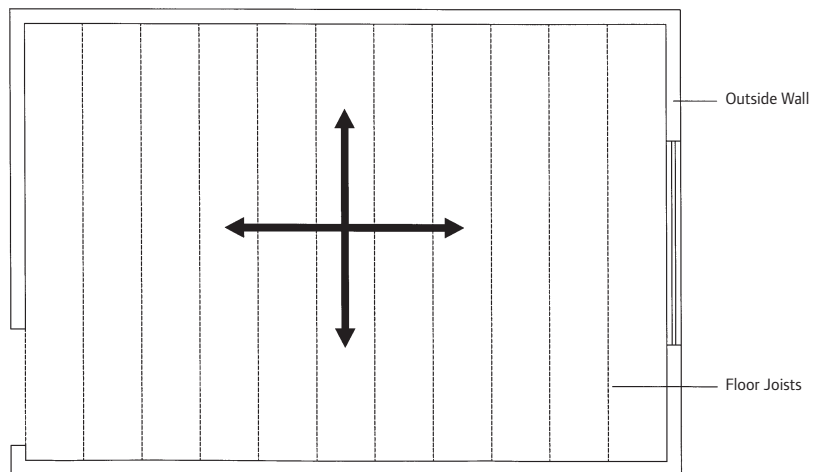

Figure 11: For a wood-finished floor covering, install Quik Trak panels perpendicular to the direction of the finished-wood floor boards.

Preliminary Layout

After determining the direction of the Quik Trak panels, design the layout.

1. Mark any areas where panels will not be installed (e.g., kitchen cabinets).
2. From the wall, measure the width of the Return Panel plus $\frac{1}{4}$ " for a total of $7\frac{1}{4}$ " (see **Distance A**).
3. Snap a chalk line to outline each of the Return Panel walls (see **Figure 12**).
4. Determine the starting point for the supply panel and snap a chalk line perpendicular to the other chalk lines using a square as a guide.

Note: For accurate results, use a square instead of the wall as a guide.

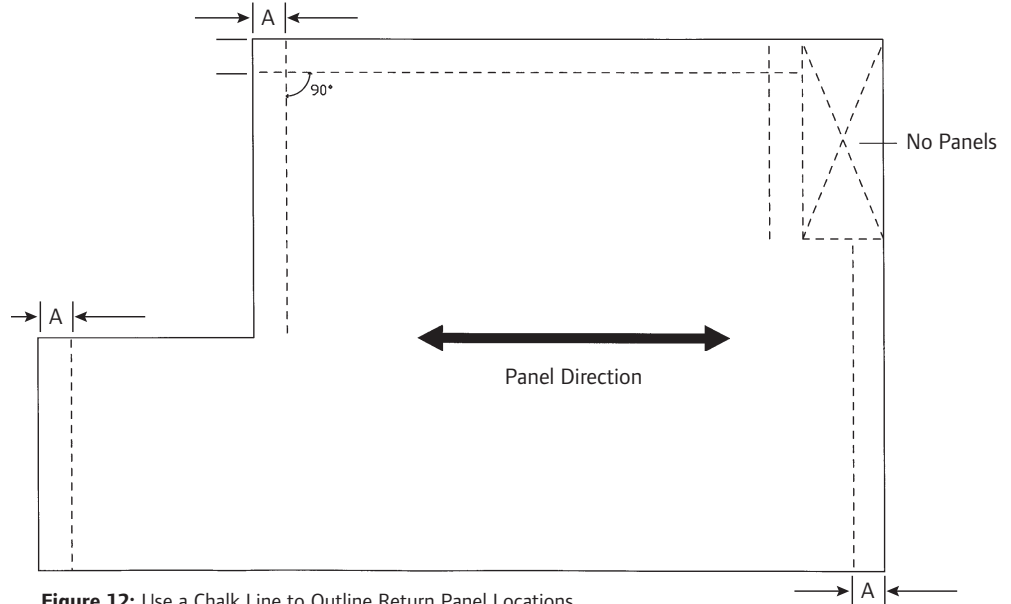

Figure 12: Use a Chalk Line to Outline Return Panel Locations

Panel Installation

1. Use a circular, power miter or table saw with a carbide blade to cut the Quik Trak panels.
2. Begin by laying the first row of panels parallel to the chalk line.
3. To improve structural integrity, stagger the panels in each row so the seams are not lined up next to each other. If you have to cut the last panel in the first row, you can use the other cut piece to start the second row. As an alternative, you may cut a panel in half and begin the second row. Continue this staggered pattern throughout the installation (see **Figure 13**).

Note: If the finished floor is hardwood, it may be necessary to install a vapor barrier below the panels. Check with the wood floor installer or manufacturer to determine the proper location and type of vapor barrier needed with their product.

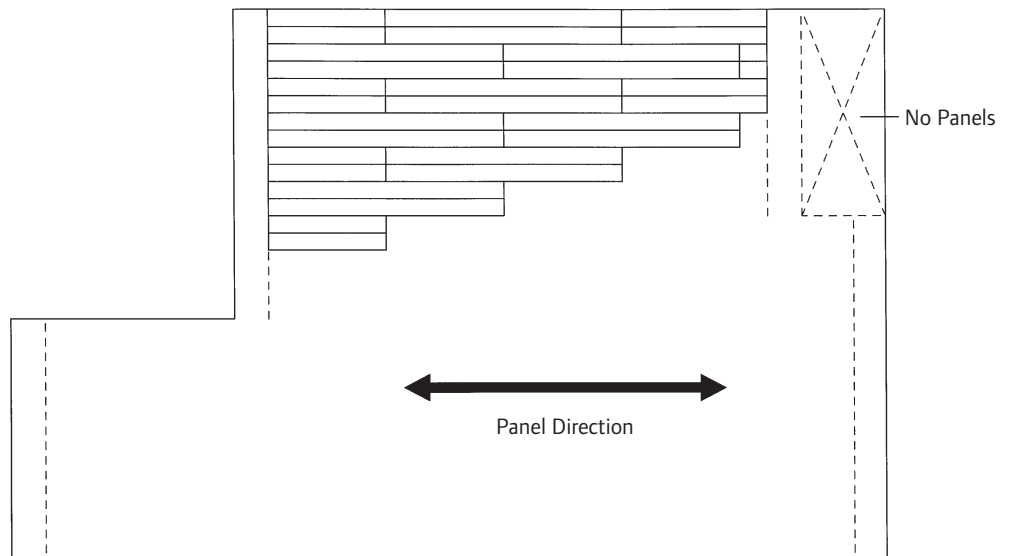

Figure 13: Stagger Panels So Seams Do Not Line Up

Panel Installation (cont.)

Begin the installation by laying down the Quik Trak panels and anchoring one side of a panel with a screw at both ends (see **Figure 14**). This allows for quick realignment, if necessary. Once the panels are properly placed, install screws on both sides of a panel. Use ten screws to ensure that the panels are secure (see **Figure 15**). Using the Quik Trak Installation Tool Kit (E6050000) will speed this process and alleviate strain from bending.

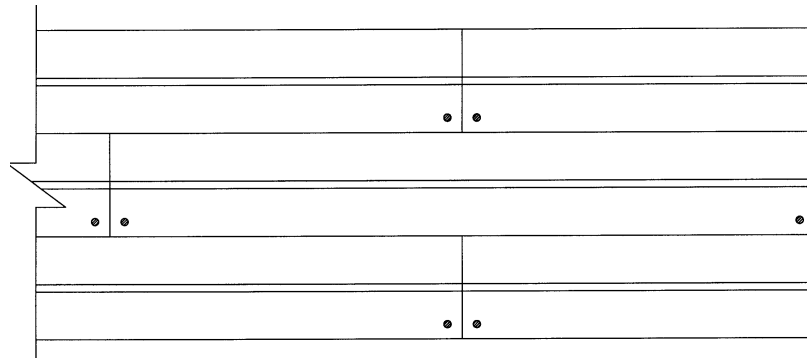

Figure 14: Anchor One Side of a Panel

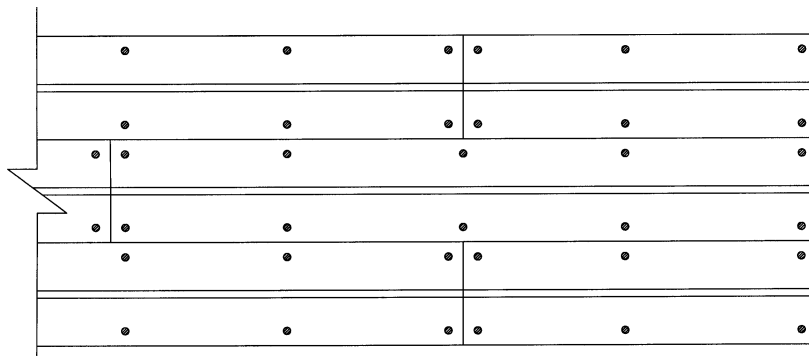

Figure 15: Fasten Panels with 10 Screws

Installing Return Panels

When the Quik Trak installation is finished, it is time to install the Return Panels.

1. Place the aluminum strips in the area where the Return Panels will be installed.
2. Trim the aluminum strips with a pair of tin snips as needed.
3. Place the Return Panels so they align with the grooves in the Quik Trak panels. Make sure to maintain a serpentine pattern for proper tubing placement (see **Figures 16 and 17**).
4. Secure the Return Panels into place using 10 screws. If necessary, you can cut Return Panels to provide 90° bends.
5. When Return Panels are in place, secure the half-moon wood pieces with a single screw to guide tubing turns.

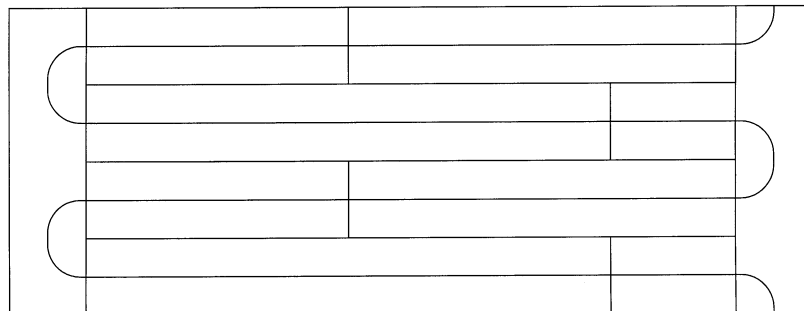

Figure 16: Correct Panel Placement for Serpentine Pattern

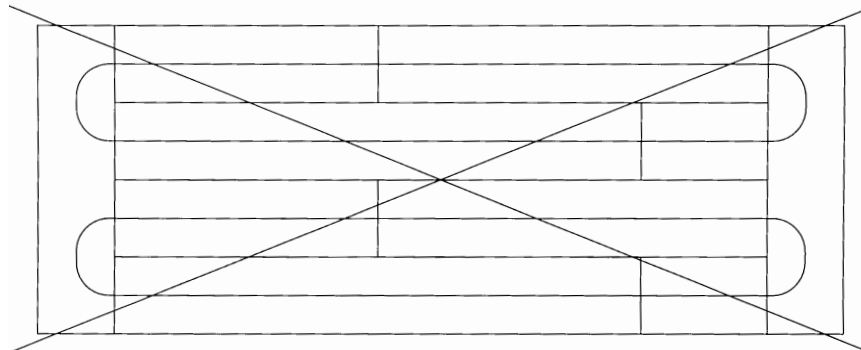

Figure 17: Incorrect Panel Placement

Final Floor Preparation

Use $\frac{1}{2}$ " plywood or similar product to fill any small areas not covered by panels (see **Figure 18**). This will make for a completely level surface. When installing panels on a suspended wood floor with access from below, determine the locations of the supply and return holes to the manifolds (see **Figures 7 and 8** on **page 10**).

Note: Leader length is crucial when calculating the number of loops for a given room. When calculating the amount of tubing that is required, remember to add the distance for the leader length to and from the manifolds. Refer to the example given on **page 2** of this manual. Also refer to **Figures 7 and 8** on **page 10**.

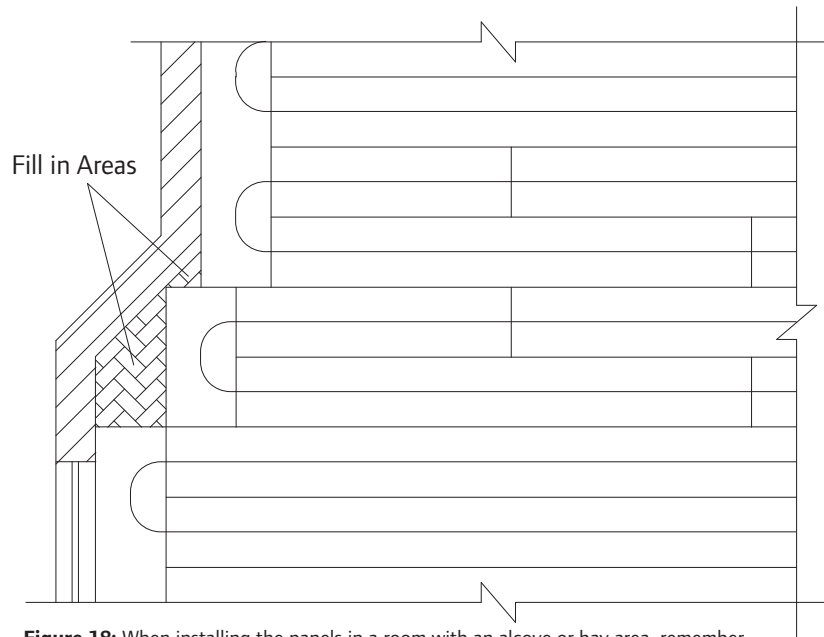

Figure 18: When installing the panels in a room with an alcove or bay area, remember to allow enough room for the Return Trak panels. Fill any areas not covered with panels with $\frac{1}{2}$ " plywood.

Tubing Installation

When the manifold location is below the subfloor, each supply and return run requires a $\frac{3}{8}$ " Metal Bend Support (A5110375) to ensure tubing alignment through the subfloor. To compensate for the bend in the support, you must create a rectangular slot in the subfloor.

First, use the $\frac{5}{8}$ " drill bit and drill two holes side by side (see **Figure 19**). Then, use a sharp wood chisel to square off the hole.

Trim $\frac{1}{2}$ " of the aluminum backing out of the groove. This will allow the $\frac{3}{8}$ " Metal Bend Support (A5110375) to be flush with the top of the panels (see **Figure 20**).

Next, vacuum the groove to remove all debris.

Begin the tubing installation by attaching the supply side to the manifold. If the leader comes from under the floor, feed the loop through the floor and attach to the supply manifold.

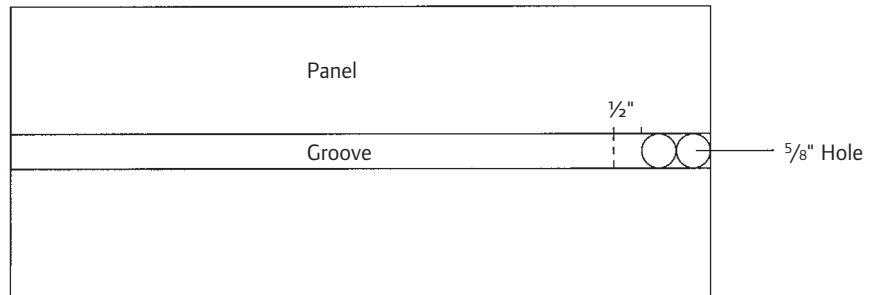

Figure 19: Drill Two Holes to Create a Rectangler Slot in the Subfloor

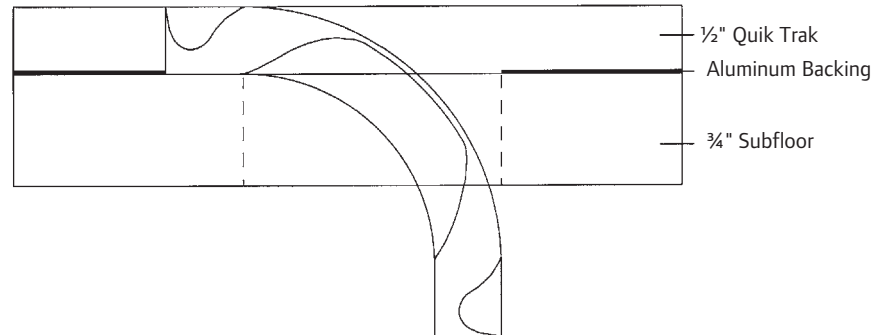

Figure 20: Trim Aluminum Backing to Allow Bend Support to be Flush with the Top of the Panels

Tubing Installation (cont.)

Once the tubing is attached to the supply manifold, secure the $\frac{3}{8}$ " Metal Bend Support to the tube where it comes out of the floor from the supply manifold. It is best to first secure the bend support on the side of the tubing that will remain below the floor. Then position the bend support at the desired point on the tubing and snap the tubing into place. Finally, push the bend support into the hole that you drilled in the Quik Trak groove.

The tubing is now attached to the supply manifold and is through the subfloor. Next, insert a $\frac{1}{8}$ " bead of sealant (see **Figure 21**). Since the sealant will become tacky in eight to 10 minutes, Uponor recommends applying the sealant to a section that can be covered with tubing in this amount of time. Next, walk the tubing into the groove. Hard-soled boots or shoes are recommended (see **Figure 22**).

If the tubing does not snap completely into the groove, first check to see if there is some obstruction under the tube. If not, use a rubber mallet or the rubber-coated base of a hammer to tap the tubing into place.

Repeat the process of applying the sealant and placing the tubing into the groove until you are a few feet from the pre-drilled hole for the run back to the return manifold. Slide the tubing through the hole and install a $\frac{3}{8}$ " Metal Bend Support as outlined in (**Figure 20**). Finish by connecting the tubing to the return manifold. Repeat this procedure for any additional loops on the manifold.

Pressure Testing

Once you are finished with all the loops to a specific manifold, pressure test the system to a minimum of 60 psi for a minimum of 24 hours or to local code requirements. After the system has



Figure 21: Insert a $\frac{1}{8}$ " bead of sealant into the panel groove.



Figure 22: Use hard-soled boots or shoes to walk the tubing into the panel groove.

been pressure tested and inspected, the finished floor can be installed.

Note: The Quik Trak system should either be under an air test or operating during the installation of the finished floor covering.

Appendix A — Advanced Design Suite (ADS) Worksheet

Project Information

Project Name _____ Date Received _____
 Project Location _____ Date Design Due _____
 Contact Person _____ Contact Number _____

Design Information

Default Settings/Components***		Suspended Floors		Notes
Outdoor design temperature		Under-floor insulation R-value		
Wall R-value		Water table present		
Ceiling R-value		Under-slab R-value		
Window R-value		Water table temperature		
Skylight R-value		Edge R-value		
Door R-value		Slab depth		
Air change/hour		Perimeter R-value		

Plan Information

Floor Level _____

Room name								
Room temp.								
Zone number								
Gross floor area								
Unheated floor area								
Net ceiling area								
Average wall height								
Floor construction*								
Floor type**								
Floor covering***								
Distance to manifold								
Assigned to manifold number								
Wall 1 (L x H)	X	X	X	X	X	X	X	X
Wall 2 (L x H)	X	X	X	X	X	X	X	X
Wall 3 (L x H)	X	X	X	X	X	X	X	X
Door 1 (L x W)	X	X	X	X	X	X	X	X
Door 2 (L x W)	X	X	X	X	X	X	X	X
Window 1 (L x W)	X	X	X	X	X	X	X	X
Window 2 (L x W)	X	X	X	X	X	X	X	X
Skylight (L x W)	X	X	X	X	X	X	X	X

***Floor Construction**
 Slab on grade = SO
 Slab below grade = SB
 Suspended over heated = SH
 Suspended over unheated = SU

****Floor Type**
 Concrete slab = C
 Poured underlayment = U
 Single plates = S
 Double plates = D
 Joist (tubing alone) = J
 Joist Trak™ = JT
 Quik Trak® = QT

*****R-values are in Appendix D.**

Appendix B — Quik Trak Design Worksheet

Quik Trak Design Worksheet

Project Name: _____ Manifold Number: _____

	Loop 1	Loop 2	Loop 3	Loop 4	Loop 5	Loop 6	Loop 7	Loop 8	Loop 9	Loop 10
A Room name										
B Room setpoint temp.										
C Zone number										
D Net floor area (ft ²)										
E Upward load (BTU/h/ft ²)										
F Total load (BTU/h/ft ²)										
G Floor surface temp.										
H Tubing size										
I Floor covering R-value										
J Differential temp.										
K Tubing o.c. distance (in)										
L Supply water temp.										
M Active loop length										
N Leader loop length										
O Total loop length										
P Loop flow in gpm										
Q Loop head pressure (ft)										
R Loop balancing turns										
S Quik Trak panels										
T Quik Trak returns										

Manifold Totals

U Supply water temp.	
V Manifold flow in gpm	
W Highest pressure head (ft)	

- A** Enter the name of the room. The room may have more than one loop.
- B** Room setpoint temperature is normally 65°F (18.3°C) for radiant floor.
- C** Zone is equal to thermostat.
- D** Enter the amount of square footage used in the room.
- E** Enter the "Floor Unit Load to Room" value from ADS printout (upward load).

- F** Enter the "Floor Unit Load" value from ADS printout (total load).
- G** $(\text{Row E}/2) + \text{Row B}$ = floor surface temperature. Do not exceed 87.5°F / 30.8°C for all floors (exception: wood floor limit is 80°F / 26.7°C).
- H** The only tubing size available for Quik Trak is 5/16" Wirsbø herPEX.
- I** Refer to **Appendix D** for floor covering information.

J Indicate differential temperature (20°F/11.1°C for Quik Trak).

K Tubing o.c. distance is 7" for Quik Trak.

L Use information from **Rows E, I, K** with **Appendix E** to obtain the supply water temperature.

M Enter the length of tubing installed within the room (i.e., active loop).

N Enter the length of the tubing from the room being heated to the respective manifold.

O Use formula: $(\text{Row M} + \text{Row N}) = \text{total loop length}$.

P Use the values in **Rows F** and **M** with **Appendix F** to obtain the flow per loop.

Q Use the values in **Rows O** and **P** with **Appendix G** to obtain the head pressure per loop. Choose the appropriate solution (water or water/glycol solution).

R These cells are calculated after the design is completed. Use the formula: (Current loop value in **Row O** x 4) / longest loop length on the manifold.

S Enter the number of panels. (For 7" o.c., multiply **Row D** by 0.386.)

T Enter the number of returns. (For 7" o.c., multiply **Row D** by 0.043.)

U Enter highest temperature from **Row L**.

V Add and enter all values from **Row P**.

W Enter highest value from **Row Q**.

Appendix C — Radiant Surface Temperature Charts

Radiant Floor

Surface Temperatures

$$\text{Floor Surface Temperature} = (\text{BTU/h/ft}^2 \div 2) + \text{Room Setpoint}$$

Room setpoint	75°F	80.0	82.5	85.0	87.5	90.0	92.5	95.0	97.5	100.0	102.5
	72°F	77.0	79.5	82.0	84.5	87.0	89.5	92.0	94.5	97.0	99.5
	70°F	75.0	77.5	80.0	82.5	85.0	87.5	90.0	92.5	95.0	97.5
	68°F	73.0	75.5	78.0	80.5	83.0	85.5	88.0	90.5	93.0	95.5
	65°F	70.0	72.5	75.0	77.5	80.0	82.5	85.0	87.5	90.0	92.5
	60°F	65.0	67.5	70.0	72.5	75.0	77.5	80.0	82.5	85.0	87.5
		10.0	15.0	20.0	25.0	30.0	35.0	40.0	45.0	50.0	55.0

BTU/h/ft²

 Exceeds the maximum recommended surface temperature for hardwood floors

 Exceeds the maximum recommended surface temperature for all floors

Radiant Ceiling

Surface Temperatures

$$\text{Ceiling Surface Temperature} = (\text{BTU/h/ft}^2 \div 1.1) + \text{Room Setpoint}$$

Room setpoint	75°F	84.1	88.6	93.2	97.7	100.0	102.3	106.8	114.4
	72°F	81.1	85.6	90.2	94.7	97.0	99.3	103.8	108.4
	70°F	79.1	83.6	88.2	92.7	95.0	97.3	101.8	106.4
	68°F	77.1	81.6	86.2	90.7	93.0	95.3	99.8	104.4
	65°F	74.1	78.6	83.2	87.7	90.0	92.3	96.8	101.4
	60°F	69.1	73.6	78.2	82.7	85.0	87.3	91.8	96.4
		10.0	15.0	20.0	25.0	27.5	30.0	35.0	40.0

BTU/h/ft²

 Exceeds the maximum recommended surface temperature for 8-foot ceilings
Maximum is 110°F for ceilings higher than 8 feet, but lower than 12 feet.

Appendix D — R-value Charts

Construction Materials	1/8"	1/4"	3/8"	1/2"	5/8"	3/4"
Plywood (Douglas fir)		0.31	0.47	0.62	0.77	0.93
Oriented strand board (OSB)		0.31	0.47	0.62	0.78	0.94
Asbestos-cement board	0.03	0.06	0.09			
Particle board (underlayment)	0.17	0.33	0.49	0.66	0.82	

Sheet Goods

Vinyl	0.20					
Linoleum (uninsulated)	0.20					
Linoleum (insulated)		0.40				

Tiles and Stone

Ceramic tile		0.23	0.34	0.45	0.57	0.68
Cork tile	0.28	0.56	0.84			
Limestone			0.38	0.50	0.63	0.76
Quarried stone			0.30	0.40	0.50	0.60
Marble		0.20	0.30	0.40	0.50	0.60
Brick			0.38	0.50	0.63	0.76

Carpeting

Commercial glue down		0.60	0.90			
Acrylic level loop		1.04	1.56	2.08	2.60	3.12
Acrylic plush		0.83	1.25	1.66	2.08	2.49
Polyester plush		0.96	1.44	1.92	2.40	2.88
Nylon saxony		0.88	1.32	1.76	2.20	2.64
Nylon shag		0.54	0.81	1.08	1.35	1.62
Wool plush		1.10	1.65	2.20	2.75	3.30

Carpet Pads

Rubber (solid)		0.31	0.47	0.62	0.78	0.93
Rubber (waffled)		0.62	0.93	1.24	1.55	1.86
Hair and jute		0.98	1.47	1.96	2.45	2.94
Prime urethane (2-lb. density)		1.08	1.62	2.16	2.70	3.24
Bonded urethane (4-lb. density)		1.04	1.56	2.08	2.60	3.12
Bonded urethane (8-lb. density)		1.10	1.65	2.20	2.75	3.30

Wood Flooring	1/8"	1/4"	3/8"	1/2"	5/8"	3/4"
Ash			0.35	0.47	0.59	0.71
Cherry			0.35	0.46	0.58	0.69
Elm			0.33	0.45	0.56	0.67
Redwood			0.51	0.68	0.84	1.01
Maple			0.35	0.46	0.58	0.69
Oak			0.33	0.45	0.56	0.67
Walnut			0.34	0.45	0.57	0.68
Douglas fir			0.40	0.53	0.66	0.80
Southern pine			0.38	0.50	0.62	0.75
Spruce			0.51	0.68	0.84	1.01
Floating wood floor pad	0.20	0.40				

Windows

Single glass	0.91
Single glass with storm	2.00
Double glazed – 3/16" air space	1.61
Double glazed – 1/4" air space	1.69
Double glazed – 1/2" air space	2.04
Double glazed – 3/4" air space	2.38
Double glazed – with suspended film	2.77
Double glazed – with 2 suspended films	3.85
Low-E	3.13
Low-E – with suspended film	4.05
Low-E – with 2 suspended films	5.05

Note: The R-values depicted in this chart are representative and may vary by manufacturer. For specific R-values, check with the appropriate floor covering manufacturer.

Appendix E — Supply Water Temperature Charts

Quik Trak Radiant Floor

65°F Room Setpoint Temperature

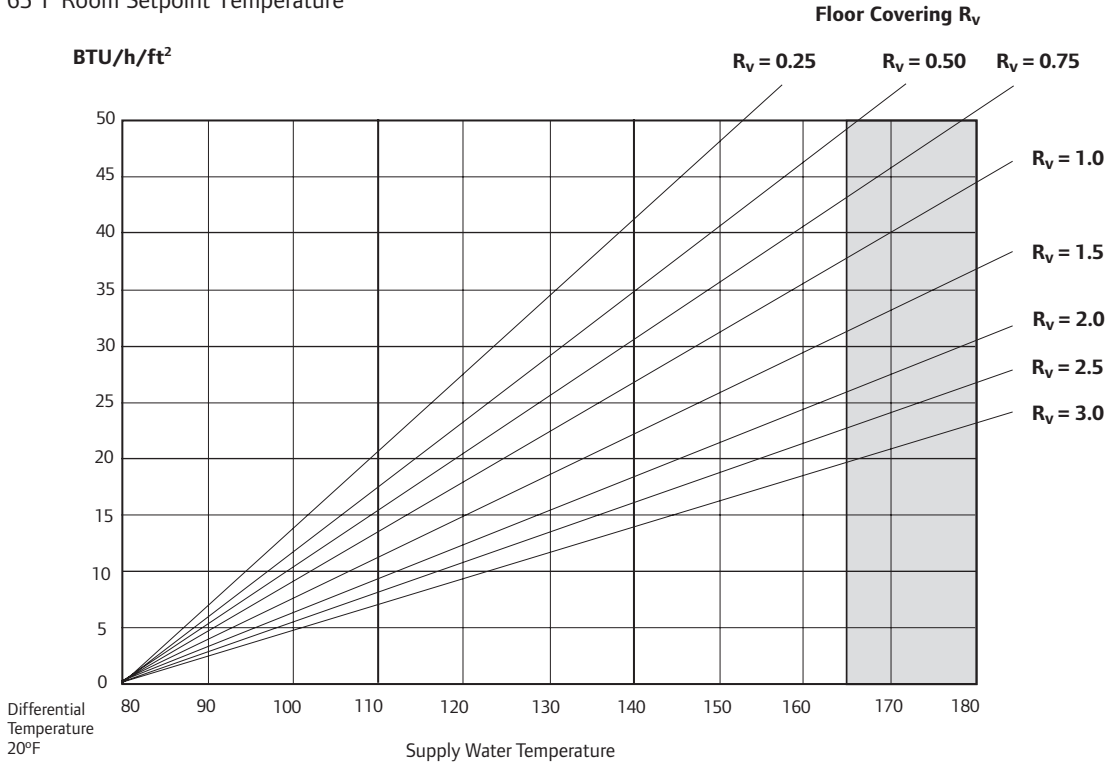

Note: Uponor's recommended maximum design temperature is 165°F.

Quik Trak Radiant Wall

70°F Room Setpoint Temperature

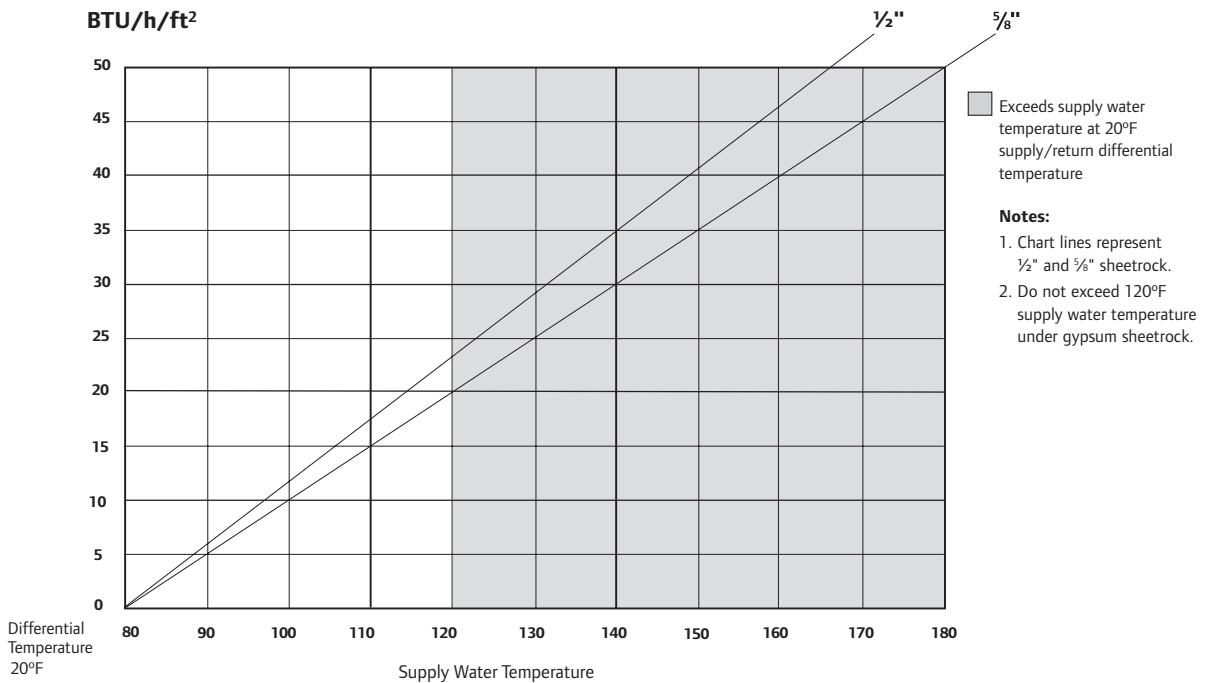

Appendix F — Flow Chart

Refer to the following instructions to determine the flow per loop for a room.

- The room is 12 ft. by 12 ft. with the tubing installed at 7" o.c.
The load for the room is 40 BTU/h/ft². The room is 15 ft. from the manifold location.
 - First determine the amount of tubing in the room.
12 x 12 = 144 sq. ft.
144 x 1.333 = 192 ft.
There is 192 ft. of active loop in the room.
 - Next, determine the amount of leader length from the room to the manifold location. The distance from the room to the manifold location is 15 ft. The distance is doubled to account for the supply and return tubing.
15 x 2 = 30 ft.
Vertical distance of tubing at the manifold = 3 ft.
30 + 6 = 36 ft.
There is 36 feet of leader length for this loop.
 - Total loop length is the active and leader length added together.
192 + 36 = 228 total loop length
 - Determine the flow for the loop by accessing data from the flow chart at right.
1. Enter the chart at the BTU/h/ft² for the room (40) to get the value in gallons per minute (gpm) per foot of tubing (0.00236).
 2. Multiply the active loop length by the value found in the line above.
192 x 0.00236 = 0.45 gpm
 3. Flow for the loop is 0.45 gpm.

100% Water at 120°F (48.9°C)

20°F (11.1°C) Supply/Return Differential Flow in GPM Per Foot of Tubing

BTU/h/ft ²	7" tubing on-center distance	BTU/h/ft ²	7" tubing on-center distance
50	0.00296	27	0.00160
49	0.00290	26	0.00154
48	0.00284	25	0.00148
47	0.00278	24	0.00142
46	0.00272	23	0.00136
45	0.00266	22	0.00130
44	0.00260	21	0.00124
43	0.00254	20	0.00118
42	0.00248	19	0.00112
41	0.00242	18	0.00106
40	0.00236	17	0.00101
39	0.00231	16	0.00095
38	0.00225	15	0.00089
37	0.00219	14	0.00083
36	0.00213	13	0.00077
35	0.00207	12	0.00071
34	0.00201	11	0.00065
33	0.00195	10	0.00059
32	0.00189	9	0.00053
31	0.00183	8	0.00047
30	0.00177	7	0.00041
29	0.00171	6	0.00035
28	0.00166	5	0.00030

Note: Flow is based on the active loop length in the room. Head pressure drop is computed from the flow for the loop and the total loop length. Do not use the total loop length to determine the flow for the loop. See **Appendix G** for the hydronic friction loss table.

Appendix G — Hydronic Friction Loss Table

5/16" Uponor PEX-a — 100% Water — Feet of Head per Foot of Tubing

Velocity (ft./sec.)	GPM	80°F 27°C	90°F 32°C	100°F 38°C	110°F 43°C	120°F 49°C	130°F 54°C	140°F 60°C	150°F 66°C	160°F 71°C	170°F 77°C	180°F 82°C	190°F 88°C	200°F 93°C
0.5	0.10	0.00908	0.00873	0.00841	0.00814	0.00789	0.00767	0.00747	0.00729	0.00712	0.00697	0.00683	0.00670	0.00659
0.6	0.13	0.01230	0.01183	0.01141	0.01105	0.01072	0.01043	0.01016	0.00992	0.00970	0.00950	0.00931	0.00914	0.00899
0.7	0.15	0.01591	0.01531	0.01479	0.01433	0.01391	0.01354	0.01320	0.01289	0.01261	0.01235	0.01212	0.01190	0.01170
0.8	0.17	0.01990	0.01917	0.01852	0.01795	0.01744	0.01698	0.01657	0.01619	0.01584	0.01552	0.01523	0.01496	0.01471
0.9	0.19	0.02426	0.02338	0.02261	0.02192	0.02131	0.02075	0.02025	0.01979	0.01938	0.01899	0.01864	0.01832	0.01802
1.0	0.21	0.02898	0.02795	0.02703	0.02622	0.02550	0.02484	0.02425	0.02371	0.02322	0.02276	0.02235	0.02197	0.02161
1.1	0.23	0.03405	0.03285	0.03179	0.03085	0.03000	0.02924	0.02856	0.02793	0.02735	0.02682	0.02634	0.02589	0.02548
1.2	0.25	0.03946	0.03808	0.03687	0.03579	0.03482	0.03395	0.03316	0.03243	0.03178	0.03116	0.03061	0.03010	0.02962
1.3	0.27	0.04520	0.04364	0.04226	0.04104	0.03994	0.03895	0.03805	0.03723	0.03648	0.03579	0.03516	0.03458	0.03404
1.4	0.29	0.05127	0.04952	0.04797	0.04660	0.04536	0.04424	0.04324	0.04231	0.04147	0.04068	0.03998	0.03932	0.03871
1.5	0.31	0.05767	0.05572	0.05399	0.05246	0.05107	0.04983	0.04870	0.04767	0.04673	0.04585	0.04506	0.04433	0.04365
1.6	0.33	0.06438	0.06222	0.06031	0.05861	0.05707	0.05569	0.05445	0.05330	0.05226	0.05128	0.05041	0.04959	0.04884
1.7	0.35	0.07141	0.06903	0.06692	0.06505	0.06336	0.06184	0.06047	0.05920	0.05805	0.05698	0.05601	0.05512	0.05428
1.8	0.38	0.07874	0.07614	0.07383	0.07178	0.06993	0.06826	0.06676	0.06537	0.06411	0.06293	0.06187	0.06089	0.05997
1.9	0.40	0.08638	0.08355	0.08103	0.07880	0.07678	0.07496	0.07332	0.07180	0.07043	0.06914	0.06799	0.06692	0.06592
2.0	0.42	0.09433	0.09125	0.08852	0.08609	0.08390	0.08193	0.08014	0.07850	0.07701	0.07561	0.07435	0.07319	0.07210
2.1	0.44	0.10257	0.09924	0.09629	0.09367	0.09130	0.08916	0.08723	0.08545	0.08384	0.08233	0.08097	0.07970	0.07853
2.2	0.46	0.11110	0.10752	0.10434	0.10152	0.09896	0.09666	0.09458	0.09266	0.09092	0.08929	0.08782	0.08646	0.08519
2.3	0.48	0.11993	0.11609	0.11267	0.10964	0.10689	0.10442	0.10219	0.10013	0.09826	0.09650	0.09493	0.09346	0.09210
2.4	0.50	0.12905	0.12494	0.12128	0.11803	0.11509	0.11244	0.11005	0.10784	0.10584	0.10396	0.10227	0.10070	0.09924
2.5	0.52	0.13845	0.13406	0.13015	0.12669	0.12355	0.12072	0.11816	0.11580	0.11367	0.11165	0.10985	0.10817	0.10661
2.6	0.54	0.14814	0.14346	0.13930	0.13561	0.13226	0.12925	0.12653	0.12401	0.12174	0.11959	0.11767	0.11588	0.11422
2.7	0.56	0.15811	0.15314	0.14872	0.14480	0.14124	0.13804	0.13514	0.13247	0.13005	0.12777	0.12572	0.12382	0.12205
2.8	0.58	0.16836	0.16309	0.15841	0.15424	0.15047	0.14708	0.14400	0.14117	0.13860	0.13618	0.13401	0.13199	0.13011
2.9	0.61	0.17888	0.17331	0.16835	0.16395	0.15996	0.15636	0.15311	0.15011	0.14739	0.14483	0.14253	0.14039	0.13840
3.0	0.63	0.18968	0.18380	0.17856	0.17391	0.16970	0.16590	0.16246	0.15929	0.15641	0.15371	0.15128	0.14902	0.14692
3.1	0.65	0.20076	0.19456	0.18904	0.18413	0.17968	0.17568	0.17205	0.16871	0.16568	0.16282	0.16026	0.15788	0.15566
3.2	0.67	0.21210	0.20558	0.19977	0.19460	0.18992	0.18571	0.18189	0.17837	0.17517	0.17217	0.16947	0.16696	0.16462
3.3	0.69	0.22372	0.21686	0.21075	0.20533	0.20041	0.19597	0.19196	0.18826	0.18490	0.18174	0.17890	0.17626	0.17380
3.4	0.71	0.23560	0.22841	0.22200	0.21630	0.21114	0.20648	0.20227	0.19838	0.19486	0.19154	0.18856	0.18579	0.18320

If you need additional assistance or information on Quik Trak systems, please contact Uponor Technical Services Department at 800.321.4739.

For more information about radiant floor heating systems including installation methods, wiring diagrams, control strategies and product information, consult the Uponor Complete Design Assistance Manual (CDAM).

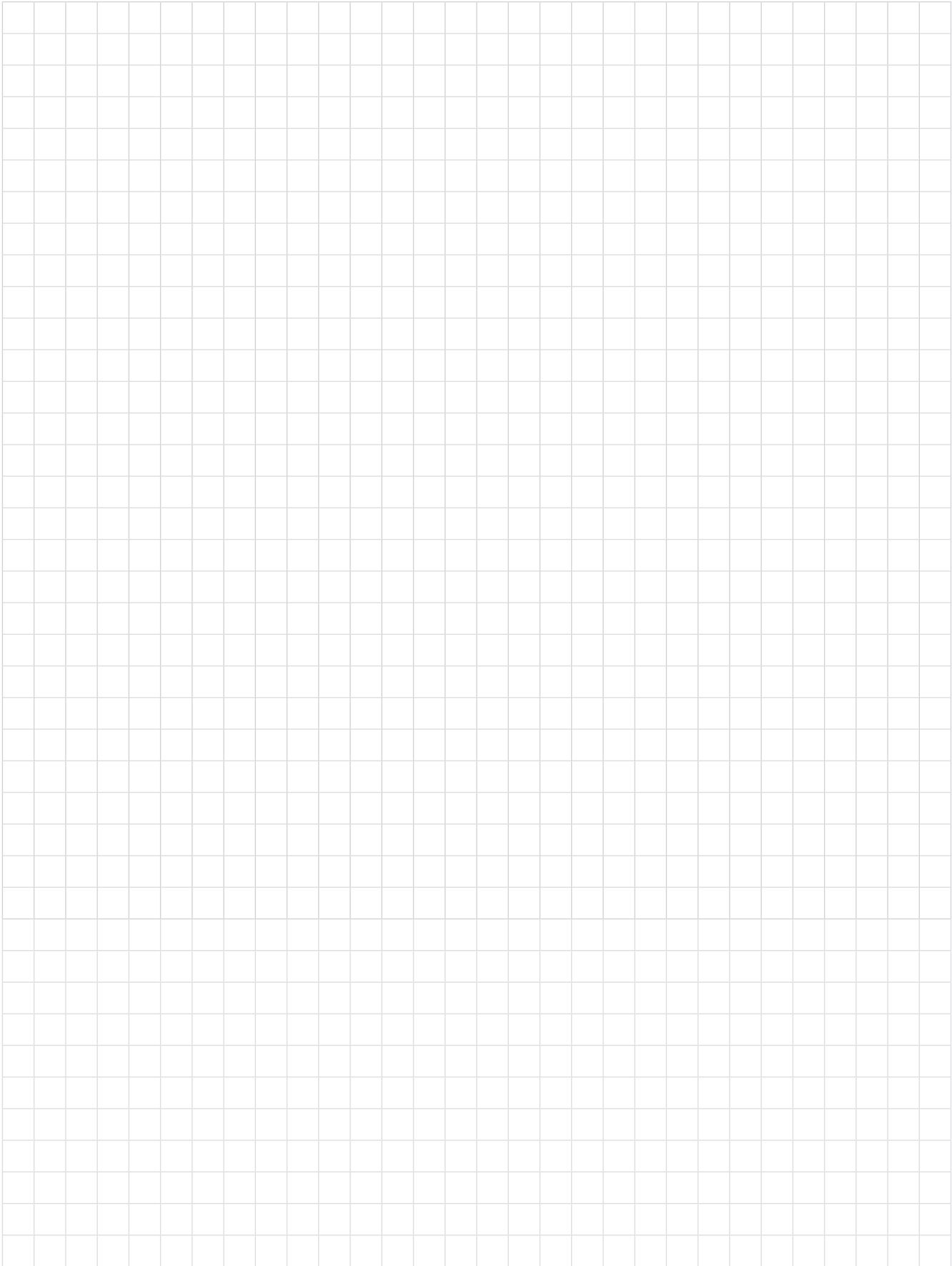

Uponor, Inc.
5925 148th Street West
Apple Valley, MN 55124 USA
Tel: 800.321.4739
Fax: 952.891.2008

Uponor Ltd.
2000 Argentia Rd., Plaza 1, Ste. 200
Mississauga, ON L5N 1W1 CANADA
Tel: 888.994.7726
Fax: 800.638.9517

Uponor
www.uponorpro.com