



RELIABILITY BUILT IN™

**Limited One Year Warranty  
(Commercial Applications)**

T&S warrants to the original purchaser (other than for purposes of resale) that such product is free from defects in material and workmanship for a period of one (1) year from the date of purchase. During this one-year warranty period, if the product is found to be defective, T&S shall, at its options, repair and/or replace it. To obtain warranty service, products must be returned to...

*T&S Brass and Bronze Works, Inc.  
Attn: Warranty Repair Department  
2 Saddleback Cove  
Travelers Rest, SC 29690*

Shipping, freight, insurance, and other transportation charges of the product to T&S and the return of repaired or replaced product to the purchaser are the responsibility of the purchaser. Repair and/or replacement shall be made within a reasonable time after receipt by T&S of the returned product. This warranty does not cover items which have received secondary finishing or have been altered or modified after purchase, or for defects caused by physical abuse to or misuse of the product, or shipment of the products.

Any express warranty not provided herein, and any remedy for Breach of Contract which might arise, is hereby excluded and disclaimed. Any implied warranties of merchantability or fitness for a particular purpose are limited in duration to the warranty period provided on the product. Under no circumstances shall T&S be liable for loss of use or any special consequential costs, expenses or damages.

Some states do not allow limitations on how long and implied warranty lasts or the exclusion or limitation of incidental or consequential damages, so the above limitations or exclusions may not apply to you. Specific rights under this warranty and other rights vary from state to state.

**Attention California Residents:**

"WARNING: This product contains chemicals known to the State of California to cause cancer, and birth defects or other reproductive harm."

P/N: 098-011027-45 Rev.11  
Date: 06-08-16  
Drawn: TEH  
Checked: DMH 06-13-16  
Approved: JHB 06-17-16

# Installation and Maintenance Instructions



## PRE-RINSE SPRAY VALVE

B-0107	B-10K-J	EB-0107-J
B-0107-C	UK-0107	EB-10K
B-0107-J	UK-10K	EB-10K-C
B-10K	EB-0107	EB-10K-J
B-10K-C	EB-0107-C	

**Español:**

Instrucciones de instalación y mantenimiento

**Français:**

Instructions pour l'installation et la maintenance

**Deutsch:**

Installations- und Wartungsanleitungen

**Italiano:**

Istruzioni di installazione e manutenzione

**中文:**

安装与维护说明

# Exploded View

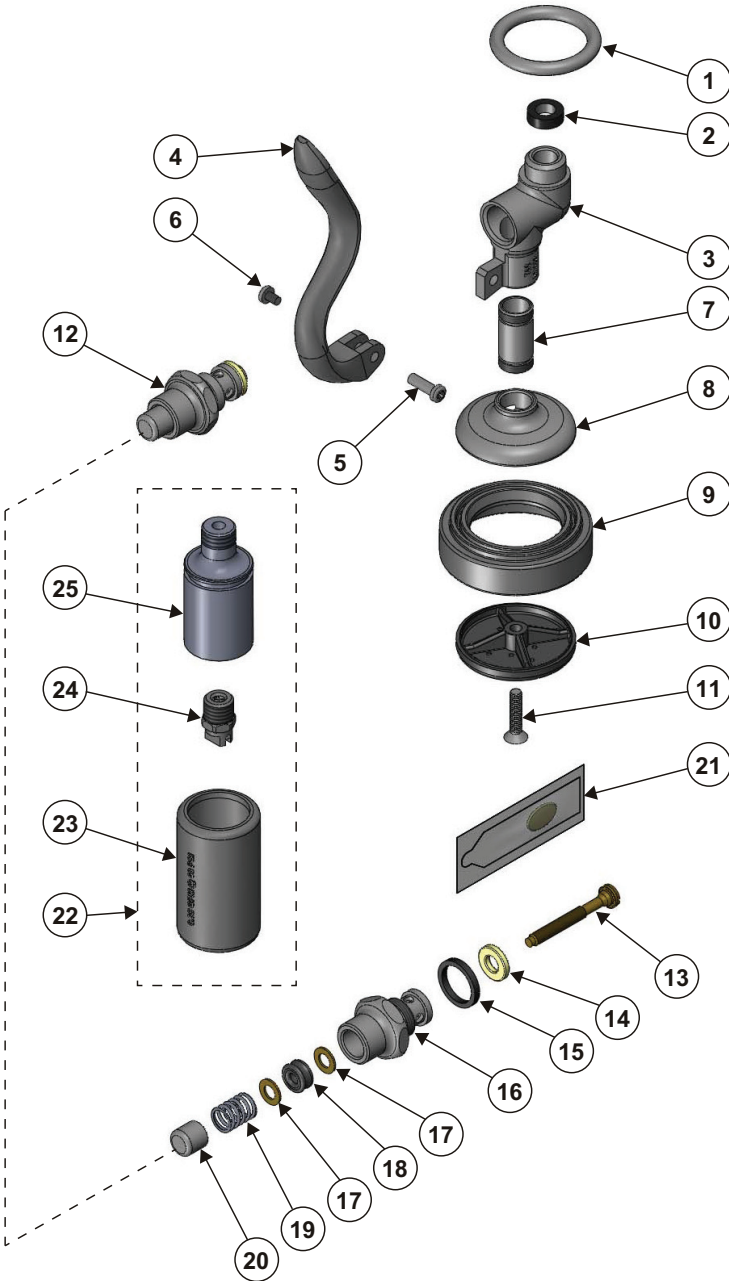

# Grey Part Number Guide

## PARTS KIT

### PARTS FOR ANY GREY T&S SPRAY VALVE

1,2,3	1	Ring, Hold Down	000907-45
	2	#27 Washer	010476-45
	3	Body, Spray Valve	000065-40
	4	Grey Handle	001120-45
	5	Nut, Handle	003198-45
	6	Screw, Handle	003199-45

### PARTS FOR ANY GREY BONNET ASSEMBLY

1,2,3	12	Bonnet Assembly	002856-40
	13	Stem	009306-20
1,2,3	14	Washer, Seat	012915-45
1,2,3	15	Washer, Bonnet Binding	001040-45
	16	Bonnet	000608-25
1,2,3	17	Washer, Bonnet Brass	000974-45
1,2,3	18	Stem, Packing	001100-45
1,2,3	19	Spring, Bonnet	000895-45
	20	Push Button	000753-25
1,2,3	21	Grease Pack	012665-45

## GREY SPRAY VALVES

### **B-0107 (1.42 GPM)**

	7	Nipple	000694-40
	8	Cup, Spray	000019-40
1	9	Ring, Sprayhead	007861-45
1	10	1.42 GPM Sprayface	001121-45
1	11	Screw, Sprayface	000913-45

### **B-0107-C (0.65 GPM)**

	22	Assembly, B-0107-C Spray Nozzle	002662-40
2	23	0.65 GPM Grey Shield ( <b>No Outline Around Lettering</b> )	002659-45
	24	0.65 GPM Spray Nozzle ( <b>0.65 Stamped on Face</b> )	N/A

### **B-0107-J (1.07 GPM)**

	22	Assembly, B-0107-J Spray Nozzle	N/A
3	23	1.07 GPM Grey Shield ( <b>Square Outline</b> )	018292-45
	24	1.07 GPM Spray Nozzle ( <b>1.07 Stamped on Face</b> )	N/A
	25	Nozzle Holder	N/A

#1 Parts included in B-10K

#2 Parts included in B-10K-C

#3 Parts included in B-10K-J

# Blue Part Number Guide

## PARTS KIT

### PARTS FOR ANY BLUE T&S SPRAY VALVE

4,5,6,7	1	Ring, Hold Down	000907-45
	2	#27 Washer	010476-45
	3	Body, Spray Valve	000065-40
	4	Blue Handle	011454-45
	5	Nut, Handle	003198-45
	6	Screw, Handle	003199-45

### PARTS FOR ANY BLUE BONNET ASSEMBLY

4,5,6,7	12	Bonnet Assembly	010594-40
	13	Stem	009306-20
4,5,6,7	14	Washer, Seat	010563-45
4,5,6,7	15	Washer, Bonnet Binding	010565-45
	16	Bonnet	000608-25
4,5,6,7	17	Washer, Bonnet Brass	000974-45
4,5,6,7	18	Quad Seal	014615-45
4,5,6,7	19	Spring, Bonnet	000895-45
	20	Push Button	000753-25
4,5,6,7	21	Grease Pack	010573-45

## BLUE SPRAY VALVES

### EB-0107 & UK-0107 Only

	7	Nipple	000694-40
	8	Cup, Spray	000019-40
4,7	9	Ring, Sprayhead	011475-45
4,7	11	Screw, Sprayface	000913-45
		<b>EB-0107 (4-6 GPM)</b>	
4	10	4-6 GPM Sprayface (No Wording on Face)	011456-45
		<b>UK-0107 (1.42 GPM)</b>	
7	10	1.42 GPM Sprayface (Flow Rate on Face)	N/A
		<b>EB-0107-C (0.65 GPM)</b>	
	22	Assembly, EB-0107-C Spray Nozzle	N/A
5	23	0.65 GPM Blue Shield (No Outline Around Lettering)	011499-45
	24	0.65 GPM Spray Nozzle (0.65 Stamped on Face)	N/A
		<b>EB-0107-J (1.07 GPM)</b>	
	22	Assembly, EB-0107-J Spray Nozzle	N/A
6	23	1.07 GPM Blue Shield (Square Outline)	018293-45
	24	1.07 GPM Spray Nozzle (1.07 Stamped on Face)	N/A
	25	Nozzle Holder	N/A

#4 Parts included in EB-10K

#5 Parts included in EB-10K-C

#6 Parts included in EB-10K-J

#7 Parts included in UK-10K

# General Instructions

## To replace worn parts:

1. Shut off water supply and drain lines. For ease of disassembly and reassembly, the *handle grip* can be removed from no.3.
2. Unscrew no.5 and no.6 to remove no.4. Unscrew and remove no.16 from no.3.
3. Hold no.20 with pliers in one hand, and with screwdriver, carefully unscrew no.13 from no.16.

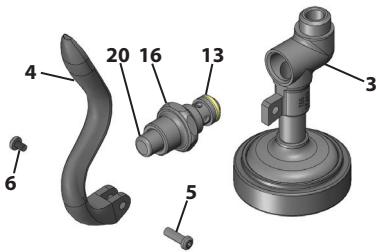

4. Apply no.21 over smooth portion of no.13. Replace no.14, no.15, no.17, no.18 & no.19 with new parts. Dab no.21 onto valve side of no.19 before replacing.

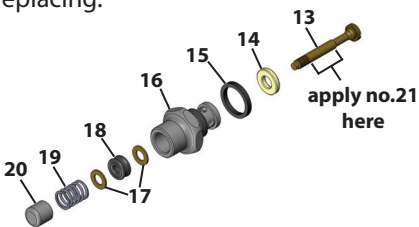

5. Reassemble no.16 by inserting no.13 through all parts. Hold no.20 with pliers, and carefully screw no.13 into no.20 until screw feels tight. Do not use excessive force.
6. Reinsert no.16 in no.3 and tighten securely.
7. Reassemble no.4, no.5 and no.6 on no.3.

8. **For EB-0107/UK-0107 & B-0107 ONLY:** To replace no.9, unscrew no.11 and disassemble. Make sure the groove side of no.9 fits over no.8, and no.10 rest on ridge side. See Figure A.

9. To replace no.2, unscrew handle grip from no.3 and replace with new no.2.

10. Reassemble; turn on water check for leaks.

Figure A

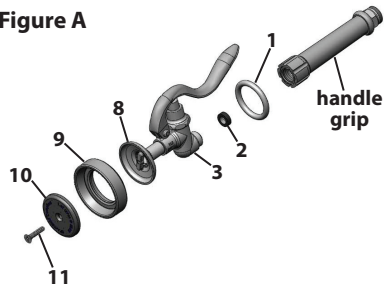

11. **For EB-0107-C, EB-0107-J, B-0107-C & B-0107-J ONLY:** To replace no.23, slide no.23 off no.25, and slide a new no.23 back onto no.25. No.23 will snap into groove on no.25. See Figure B.

\* **Verify the flow rate on no.23 matches spray tip inside no.25.**

Figure B

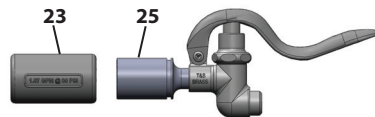

**Caution: Turn off water supply at base faucet when not in use.**

# Instrucciones Generales

## Para reemplazar las piezas desgastadas:

1. Corte el suministro de agua y drene las líneas. Para facilitar el desarmado y armado, el *mango de la manija* se puede quitar del n.º 3.
2. Destornille el n.º 5 y n.º 6 para quitar el n.º 4. Destornille y quite el n.º 16 del n.º 3.
3. Con una mano sostenga el n.º 20 con pinzas y con el destornillador quite cuidadosamente el n.º 13 del n.º 16.

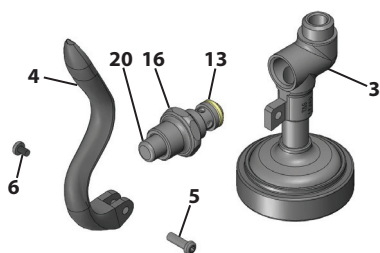

4. Aplique el n.º 21 sobre una parte del n.º 13. Reemplace los números 14, 15, 17, 18 y 19 con partes nuevas. Golpee ligeramente el n.º 21 por el lado de la válvula del n.º 19 antes de reemplazarlo.



5. Vuelva a armar el n.º 16 insertando el n.º 13 por todas las partes. Sostenga el n.º 20 con pinzas y atornille cuidadosamente el n.º 13 dentro del n.º 20 hasta que el tornillo quede ajustado. No aplique fuerza excesiva.
6. Vuelva a insertar el n.º 16 dentro del n.º 3 y ajuste firmemente.
7. Vuelva a armar los números 4, 5 y 6 en el n.º 3.

8. **ÚNICAMENTE PARA EB-0107/UK-0107 y B-0107** : Para reemplazar el n.º 9, destornille el n.º 11 y desarme. Asegúrese de que el lado de la ranura del n.º 9 se ajuste al n.º 8, y que el n.º 10 descansa en el borde. Véase la figura A.
9. Para reemplazar el n.º 2, destornille el mango de la manija del n.º 3 y reemplace con el n.º 2 nuevo.
10. Vuelva a armar; abra el suministro de agua y verifique que no haya fugas.

Figura A

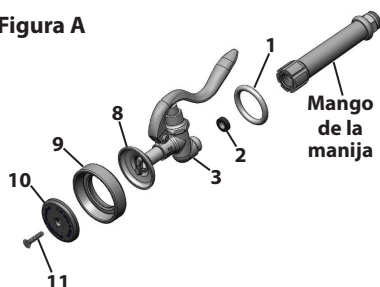

11. **ÚNICAMENTE PARA EB-0107-C, EB-0107-J, B-0107-C y B-0107-J**: Para reemplazar el n.º 23, deslícelo fuera del n.º 25 e introduzca un n.º 23 nuevo dentro del n.º 25. El n.º 23 se insertará en la ranura en el n.º 25. Véase la figura B.

*\* Verifique que la velocidad del flujo en el n.º 23 coincida con la punta de aspersión dentro del n.º 25.*

Figura B

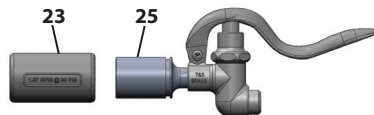

**Precaución: Corte el suministro de agua en el grifo de base cuando no lo use.**

# Instructions Générales

## **Pour remplacer les pièces usées :**

1. Coupez l'alimentation en eau et les conduites d'évacuation. Pour faciliter le démontage et le remontage, la *poignée* peut être retirée du No 3.
2. Dévissez les No 5 et 6 pour retirer le No 4. Dévissez et retirez le No 16 du No 3.
3. Immobilisez le No 20 avec une pince d'une main, et avec un tournevis, dévissez soigneusement le No 13 du No 16.

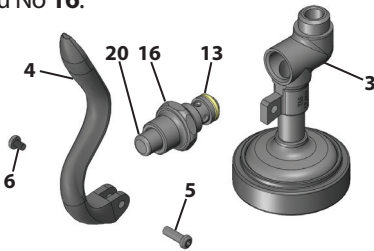

4. Appliquez le No 21 sur la portion lisse du No 13. Remplacez les No 14, 15, 17, 18 et 19 par des pièces neuves. Tamponnez le No 21 sur le côté vanne du No 19 avant le remplacement.

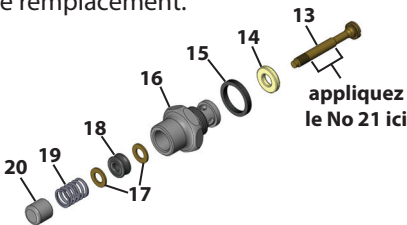

5. Remontez le No 16 en insérant le No 13 au travers de toutes les pièces. Immobilisez le No 20 avec une pince, et vissez soigneusement à fond le No 13 dans le No 20. Ne serrez pas trop.
6. Réinsérez le No 16 dans le No 3 et bien serrer.
7. Remontez les No 4, 5 et 6 sur le No 3.

## **8. POUR LES RÉFÉRENCES**

### **EB-0107/UK-0107 & B-0107**

- UNIQUEMENT :** Pour remplacer le No 9, dévissez le No 11 et procédez au démontage. Vérifiez que le côté rainure du No 9 s'adapte sur le No 8, et que le No 10 repose sur le côté de l'arête. Voir la Figure A.
9. Pour remplacer le No 2, dévissez la poignée du No 3 et installez un No 2 neuf.
  10. Remontez ; Ouvrez l'arrivée d'eau, recherchez des fuites.

**Figure A**

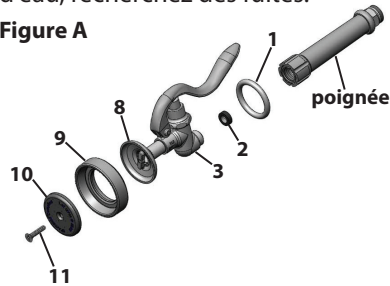

## **11. Pour les modèles EB-0107-C, EB-0107-J, B-0107-C & B-0107-J**

- UNIQUEMENT :** Pour remplacer le No 23, faites glisser le No 23 hors du No 25, et faites glisser un nouveau No 23 neuf sur le No 25. Le No 23 s'enclenche dans la saignée du No 25. Voir la figure B.

*\* Vérifiez que le débit sur le No 23 correspond à l'embout de pulvérisation à l'intérieur du No 25.*

**Figure B**

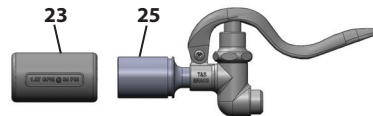

**Avertissement : Coupez l'alimentation en eau au robinet de la base lorsque le modèle n'est pas en cours d'utilisation.**

# Allgemeine Anleitungen

## **Verschleißteile ersetzen:**

1. Wasserzufuhr ausschalten und Rohre entleeren. Zum leichten Aus- und Einbau kann der *Handgriff* von Nr. 3 entfernt werden.
2. Nr. 5 und Nr. 6 abschrauben, um Nr. 4 zu entfernen. Nr. 16 aufschrauben und von Nr. 3 entfernen.
3. Nr. 20 mit der Zange in einer Hand halten und mit dem Schraubenzieher vorsichtig Nr.13 von Nr. 16 abschrauben.

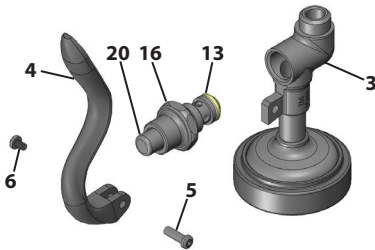

4. Nr. 21 auf dem glatten Teil von Nr. 13 anbringen. Nr. 14, Nr.15, Nr. 17, Nr.18 & Nr.19 durch neue Teile ersetzen. Nr.21 auf Ventilseite von Nr. 19 vor dem Ersetzen abtupfen.

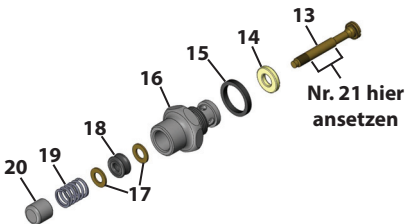

5. Nr.16 durch Einführen von Nr. 13 durch alle Teile wieder zusammenbauen. Nr. 20 mit der Zange in einer Hand halten und vorsichtig Nr. 13 in Nr. 20 schrauben bis es fest sitzt. Keine übermäßige Gewalt anwenden.
6. Nr. 16 in Nr. 3 wieder einstecken und fest anziehen.
7. Nr. 4, Nr. 5 und Nr. 6 wieder auf Nr. 3 zusammenbauen.

8. **NUR für EB-0107/UK-0107 & B-0107:** Um Nr. 9 zu ersetzen, Nr. 11 abschrauben und ausbauen. Sicherstellen, dass Rillenseite von Nr. 9 über Nr. 8 passt und Nr. 10 auf der starren Seite ruht. Siehe Abbildung A.
9. Um Nr. 2 zu ersetzen, Nr. 3 vom Handgriff abschrauben und mit einer neuen Nr. 2 ersetzen.
10. Wieder zusammenbauen, Wasserzufuhr anschalten und auf Leckagen prüfen.

**Abbildung A**

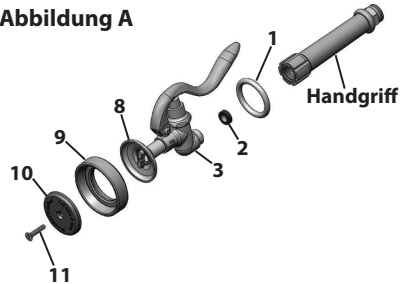

11. **NUR für EB-0107-C, EB-0107-J, B-0107-C & B-0107-J:** Um Nr. 23 zu ersetzen, Nr. 23 von Nr. 25 abnehmen und eine neue Nr. 23 wieder zurück auf Nr. 25 setzen. Nr. 23 wieder in die Rille auf Nr. 25 einrasten. Siehe Abbildung B.  
\* **Prüfen ob der Durchfluss an Nr. 23 mit der Spritzdüse in Nr. 25 übereinstimmt.**

**Abbildung B**

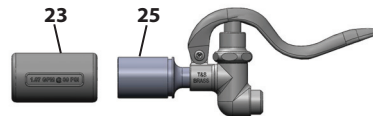

**ACHTUNG: Wasserzufuhr an der grundlegenden Armatur abstellen, wenn nicht in Gebrauch.**



# Istruzioni Generali

## Per sostituire le parti usurate:

1. Chiudere la fornitura idrica e le linee di drenaggio. Per facilità di smontaggio e rimontaggio, l'*impugnatura* può essere rimossa dal n. 3.
2. Svitare il n. 5 e il n. 6 per rimuovere il n. 4. Svitare e rimuovere il n. 16 dal n. 3.
3. Mantenere il n. 20 con le pinze in una mano e, con il cacciavite, svitare attentamente il n. 13 dal n. 16.

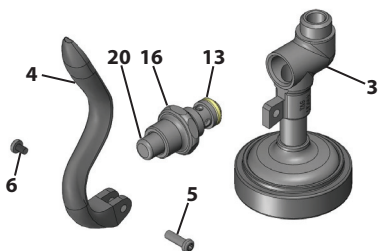

4. Applicare il n. 21 sulla porzione liscia del n. 13. Sostituire il n. 14, n. 15, n. 17, n. 18 e il n. 19 con parti nuove. Picchiare il n. 21 sul lato valvola del n. 19 prima della sostituzione.

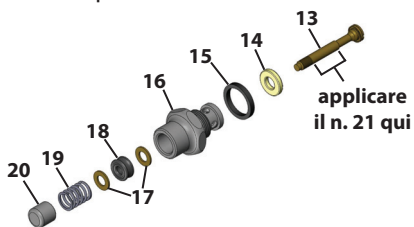

5. Riassemblare il n. 16 facendo passare il n. 13 attraverso tutte le parti. Mantenere il n. 20 con le pinze, e avvitare con cura il n. 13 nel n. 20 fino a che la vite non risulta ben serrata. Non utilizzare forza eccessiva.
6. Reinserrire il n. 16 nel n. 3 e serrare con fermezza.
7. Riassemblare il n. 4, il n. 5 e il n. 6 sul n. 3.

8. **SOLO per EB-0107/UK-0107 & B-0107** : Per sostituire il n. 9, svitare il n. 11 e smontare. Accertarsi che il lato scanalato del n. 9 entri nel n. 8, e che il n. 10 sia appoggiato sul lato dorsale. Vedere la Figura A.
9. Per sostituire il n. 2, svitare l'*impugnatura* dal n. 3 e sostituire con il nuovo n. 2.
10. Riassemblare; attivare il controllo idrico per le perdite.

Figura A

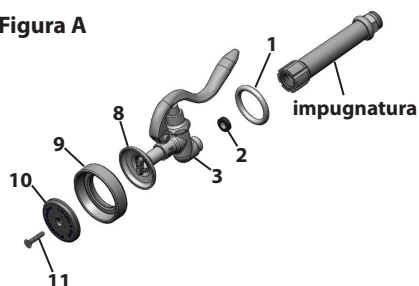

11. **SOLO per EB-0107-C, EB-0107-J, B-0107-C E B-0107-J**: Per sostituire il n. 23, fare scorrere il n. 23 dal n. 25, e fare scorrere nuovamente un nuovo n. 23 nel n. 25. Il n. 23 scatterà nella scanalatura del n. 25. Vedere la Figura B.

\* **Verificare che la portata sul n. 23 corrisponda al puntale a spruzzo all'interno del n. 25.**

Figura B

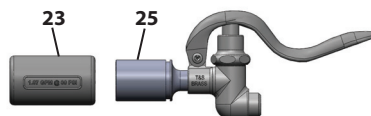

**Attenzione: disattivare la fornitura idrica al rubinetto della base quando non è in uso.**

# 一般说明

## 要更换磨损的零部件：

1. 关闭水源和排水管。为便于拆卸和重新组装，可以从编号 3 上拆下手柄把手。
2. 拧下编号 5 和编号 6 以拆下编号 4。从编号 3 上拧下编号 16。
3. 一只手用钳子夹住编号 20，然后用螺丝刀小心地从编号 16 上拧下编号 13。

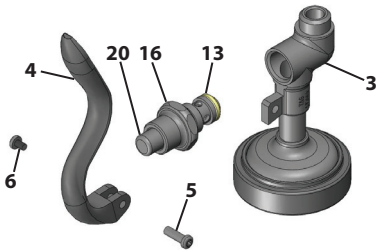

4. 将编号 21 涂抹在编号 13 的光滑部分。用新的相应零部件更换编号 14、15、17、18 和 19。更换前将编号 21 轻轻涂抹在编号 19 的阀门侧。

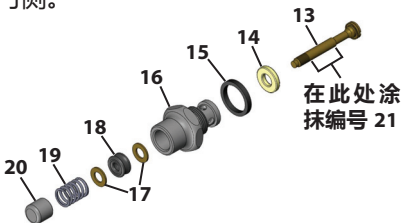

5. 将编号 13 穿过所有零部件以重新组装编号 16。用钳子夹住编号 20，然后小心地将编号 13 拧入编号 20，直到拧紧为止。请勿过度用力。
6. 将编号 16 重新插入到编号 3 并牢牢拧紧。
7. 将编号 4、5 和 6 重新组装到编号 3 上。

8. 仅适用于 EB-0107/UK-0107 和 B-0107：要更换编号 9，请拧下编号 11 并拆开。确保编号 9 的凹槽侧适合编号 8，并将编号 10 安放在凸棱侧上。见图 A。

9. 要更换编号 2，请从编号 3 上拧下手柄把手，然后用新的编号 2 进行更换。

10. 重新组装；打开水源检查是否漏水。

图 A

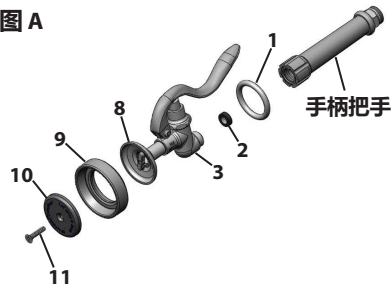

11. 仅适用于 EB-0107-C, EB-0107-J, B-0107-C 和 B-0107-J: 要更换编号 23，请将编号 23 滑出编号 25，然后将新的编号 23 滑回到编号 25 上。编号 23 将卡入编号 25 的凹槽中。见图 B。

\* 确认编号 23 的流量适合编号 25 内的喷头。

图 B

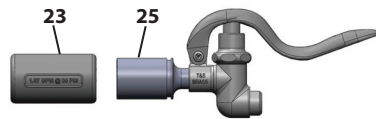

**注意：不使用时，请关闭台式龙头的水源。**

## RELATED T&S BRASS PRODUCT LINE



**B-0108  
JeTSpray  
Spray Valve**



**B-0108-C  
JeTSpray  
Low Flow  
Spray Valve**

---

## T&S BRASS AND BRONZE WORKS, INC.

A firm commitment to application-engineered plumbing products

2 Saddleback Cove, P.O. Box 1088,  
Travelers Rest, SC 29690

*Phone:* (864) 834-4102

*Fax:* (864) 834-3518

*E-mail:* [tsbrass@tsbrass.com](mailto:tsbrass@tsbrass.com)

T & S Brass-Europe  
'De Veenhoeve'  
Oude Nieuwveenseweg 84  
2441 CW Nieuwveen

The Netherlands



RELIABILITY BUILT IN™