



R841C, D, E Electric Heating Relays

INSTALLATION INSTRUCTIONS



R841C



R841E

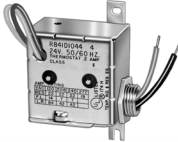

R841D

seconds after the thermostat calls for heat (within the specified ambient range and at rated voltage and frequency - see "Specifications" on page 1).

The R841 D model must be powered by a remote 24 volt Class II transformer. Leadwires are provided for both low and line voltage connections. All models are housed in Class I electrical enclosures which are equipped with a 1/2" NPT male conduit bushing for the line voltage leadwires. An adapter fitting is also provided to accommodate 3/4" NPT knockouts.

SPECIFICATIONS

Models

R841C, E - with transformer, with conduit bushing
R841D - without transformer, with conduit bushing

Voltage and Frequency

R841C, E (with transformer - specify voltage)
120, 208, 240 or 277 - VAC 50/60 Hz.
R841D (without transformer)
24 VAC 50/60 Hz.

Switch: MICRO SWITCH®, bimetal operated

Thermostat Current: 0.2 amp. (See Fig. 5, 7, 8 and 10 for exceptions). On R841E with one thermostat controlling both loads, current is 0.4A.

Ambient Temperature Range

-30 to 65 °C (-20 to 150 °F)

Switch Ratings: See Table 1

Table 1. Switch Ratings

Volts 50/60 Hz	120	208	240	277
Resist. A.	22	22	22	19
F.L.A.	14	7	7	—
L.R.A.	84	42	42	—

Underwriters Laboratories Inc. listed File No. E47434
Guide XAPX.

APPLICATION

The R841 Electric Heating Relay is for use with a two wire, low voltage thermostat to provide control of electric resistive heating equipment.

The R841C & D models may be used to directly replace earlier versions of the R841A, B, C or D models, with enclosure as well as similar competitive models. In many instances the mounting dimensions are identical to competitive devices. R841E is used either with one thermostat to control two loads simultaneously, or with two thermostats to control two independent loads.

OPERATION

On a call for heat, the thermostat energizes the low voltage resistance heater in the R841, which drives an ambient compensated bimetal to operate a spst MICRO SWITCH® snap switch. From a cold start, the R841 switch contacts make approximately 65



Dimensions

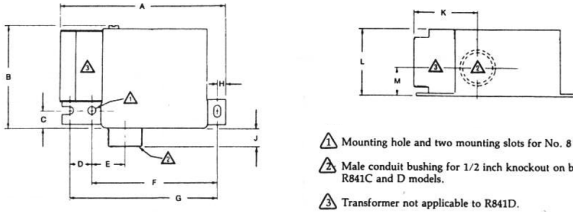

Key	A	B	C	D	E	F	G	H	J	K	L	M
mm (nom.)	100	60	10	10	20	75	85	5	10	35	40	15
Inches	3-7/8	2-3/8	13/32	15/32	3/4	2-29/32	3-3/8	1/4	7/16	1-15/32	1-1/2	5/8

Fig. 1. R841C, D nominal dimensions.

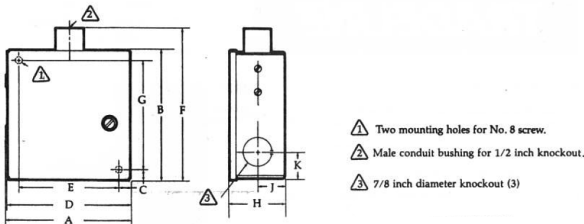

Key	A	B	C	D	E	F	G	H	J	K
mm (nom.)	100	105	10	98	80	120	85	65	20	40
Inches	3-15/16	4-1/8	3/8	3-7/8	3-1/8	4-13/16	3-3/8	2-1/2	7/8	13/16

Fig. 2. R841E nominal dimensions.

INSTALLATION

When Installing this Product...

1. Read these instructions carefully. Failure to follow them could damage the product or cause a hazardous condition.
2. Check the ratings given in the instructions and on the product to make sure the product is suitable for your application.
3. Installer must be a trained, experienced service technician.
4. After installation is complete, check out product operation as provided in these instructions.

Notes for all wiring diagrams are in "Wiring Diagram Notes" on page 3.

CAUTION

Disconnect power supply before installation to prevent electrical shock and equipment damage.

Run wiring to mounted relay and connect according to system selected. All wiring must comply with applicable local codes.

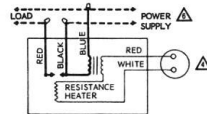

Fig. 3. R841C internal schematic and connection diagram. See applicable notes.

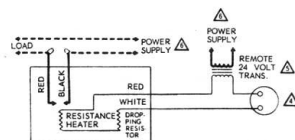

Fig. 4. R841D internal schematic and connection diagram. See applicable notes.

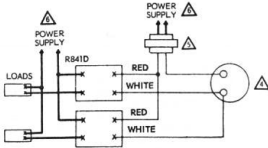

Fig. 5. Connections for two R841D Relays used with one transformer and thermostat. Set thermostat heater at 0.4 amp. See applicable note 5.

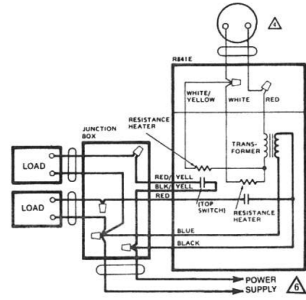

Fig. 8. R841E internal schematic and connection diagram. See applicable notes. Set thermostat heater at 0.4 amp.

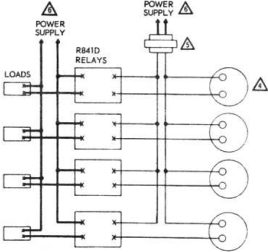

Fig. 6. Connections for four R841D Relays and thermostats used with one transformer. Set each thermostat heater at 0.2 amp.

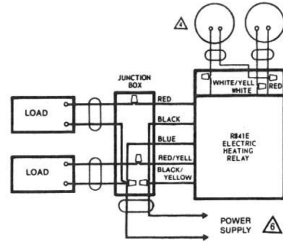

Fig. 9. Typical wiring hookup for two thermostats, each with its own load. Set each thermostat heater at 0.2 amp.

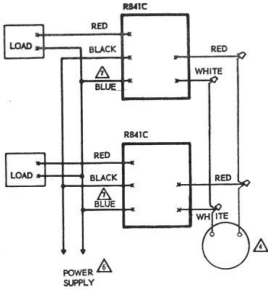

Fig. 7. Typical wiring diagram showing connections for two R841C Relays used with one two-wire low voltage thermostat. Set thermostat heater at 0.4 amp.

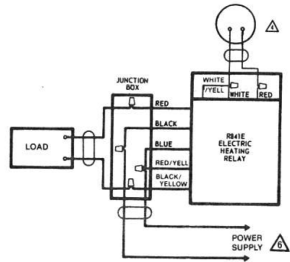

Fig. 10. Typical wiring hookup for one thermostat connected to one load so that both sides of the single phase line are switched. Set thermostat heater at 0.4 amp.

Wiring Diagram Notes

4. Two wire low voltage thermostat.
5. External transformer for use: with each (one) R841D: 24V, 5VA, N.E.C. Class II transformer, use Resideo AT72 or AT87 for up to four R841Ds.
6. Add disconnect and overload protection as required.
7. Observe all low and line voltage color codes.



resideo

www.resideo.com

Resideo Technologies, Inc.
1985 Douglas Drive North, Golden Valley, MN 55422
1-800-468-1502
95C-10124-01 M.S. Rev. 06-20 | Printed in United States

© 2020 Resideo Technologies, Inc. All rights reserved.

The Honeywell Home trademark is used under license from Honeywell International, Inc. This product is manufactured by Resideo Technologies, Inc. and its affiliates.