

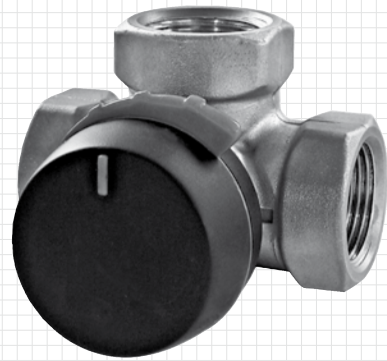

www.esbe.se

Mtrl.nr. 98 14 03 50 • Ritn.nr. 9177 utg. pA1 • Rev. 0904



### SERIES VRG130



NO.1 IN HYDRONIC SYSTEM CONTROL



Series VRG131

CE

Pressure Equipment Directive 97/23/EC

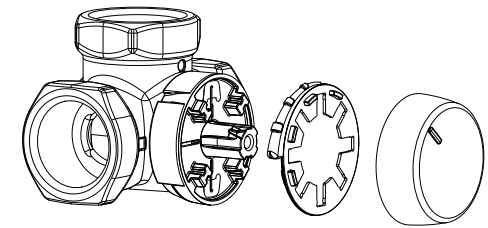
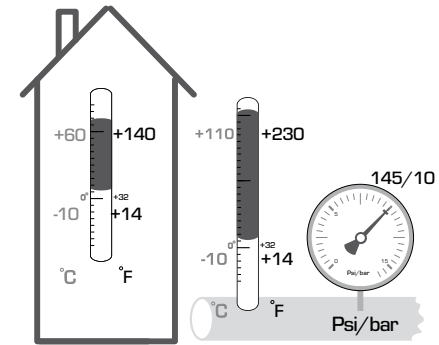

1a

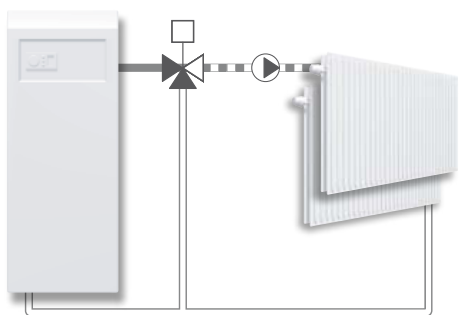
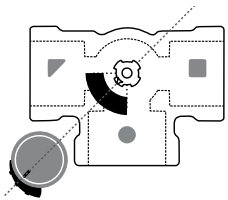

1b

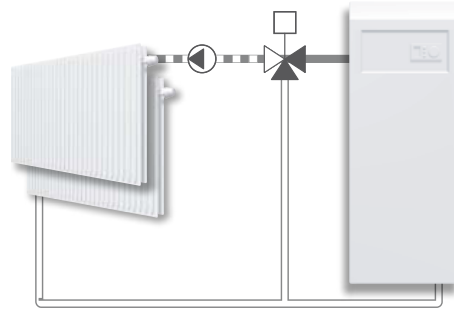
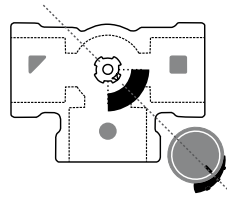

2a

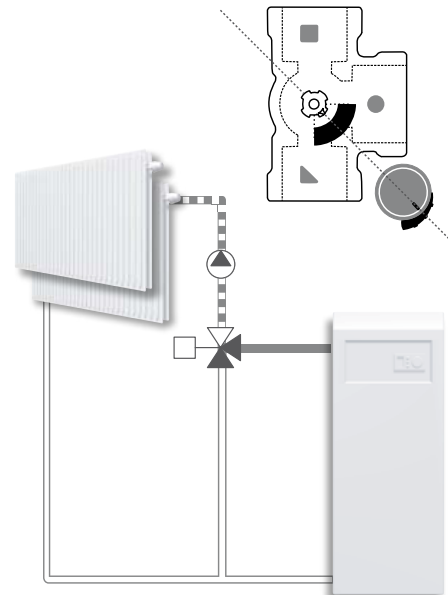

2b

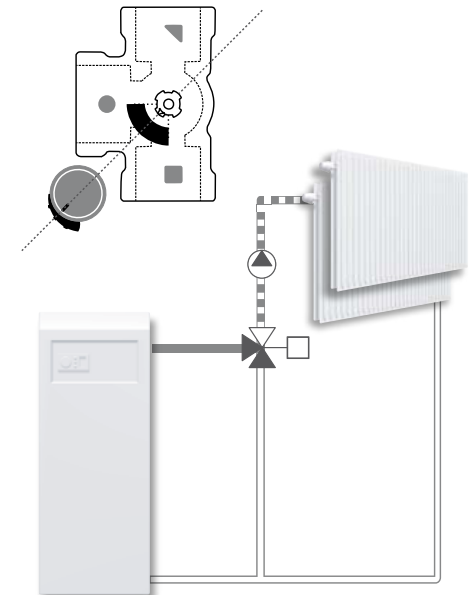

3a

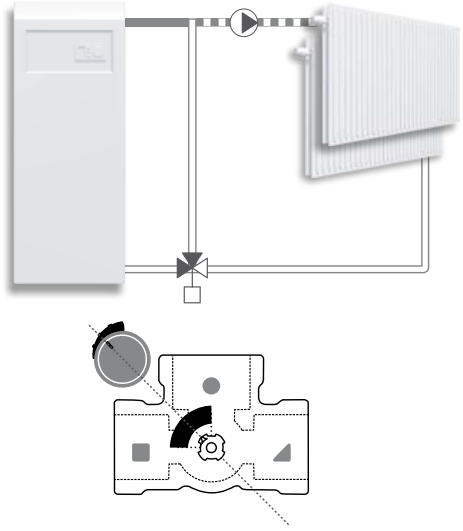

3b

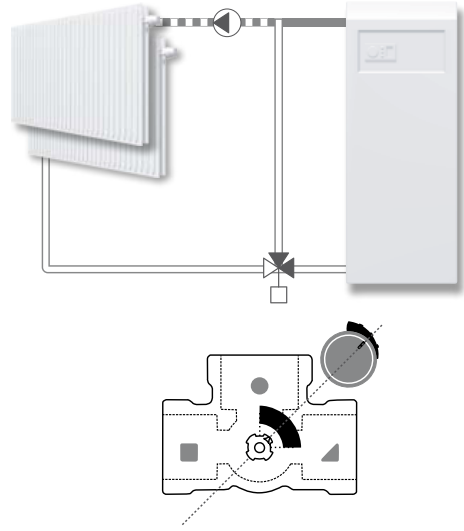

4a

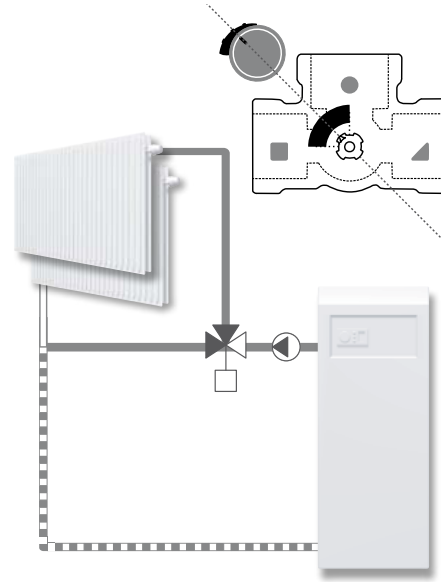

4b

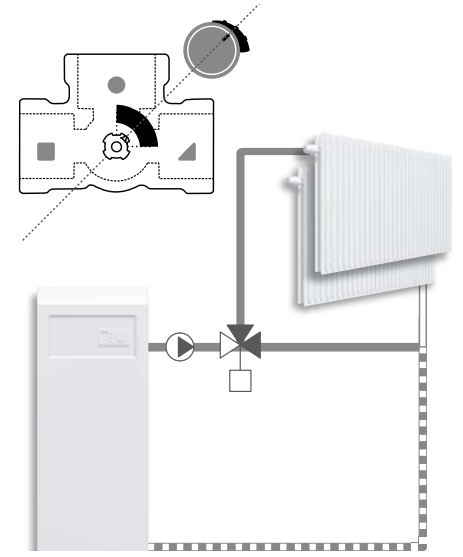

5a

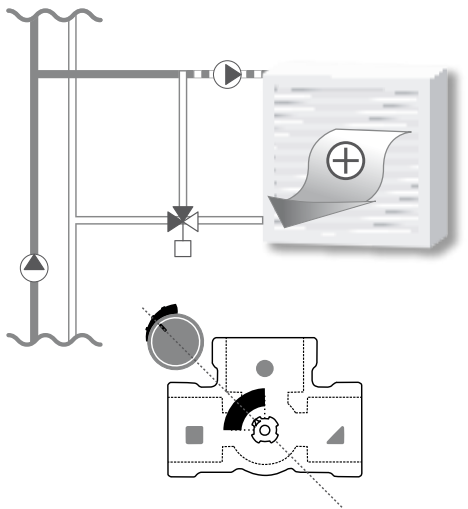

5b

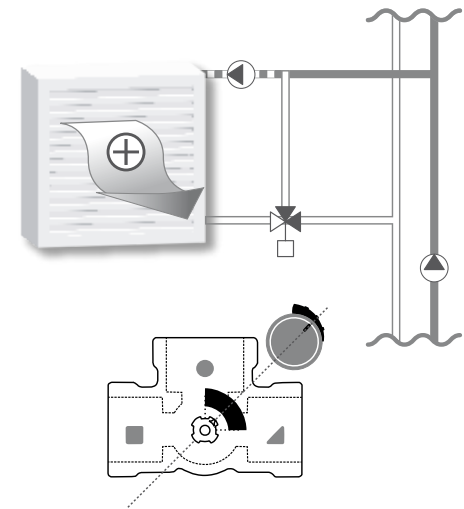

6a

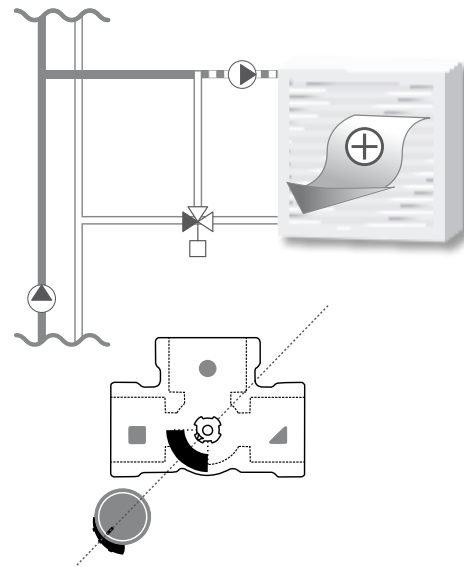

6b

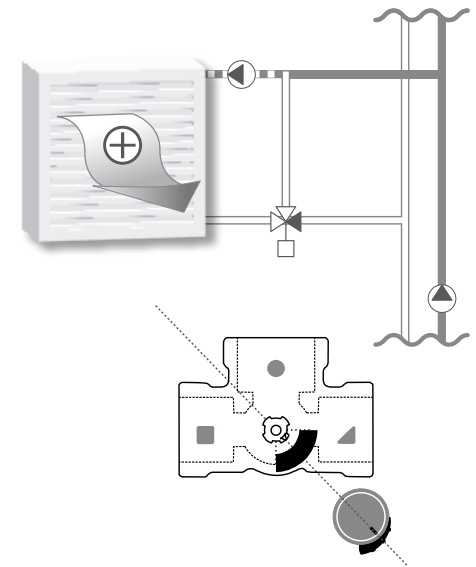

7a

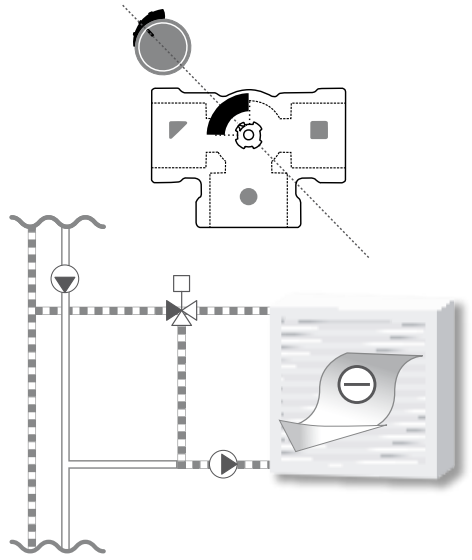

7b

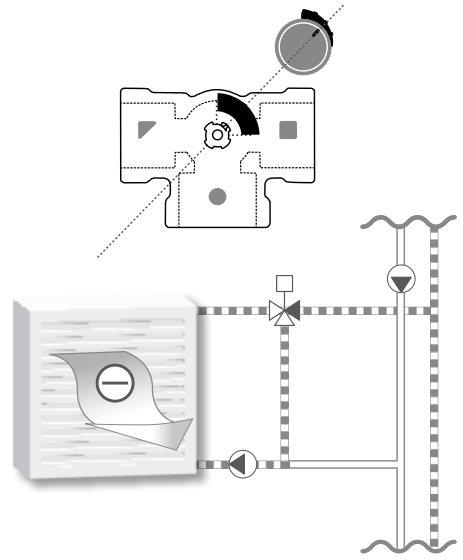

8a

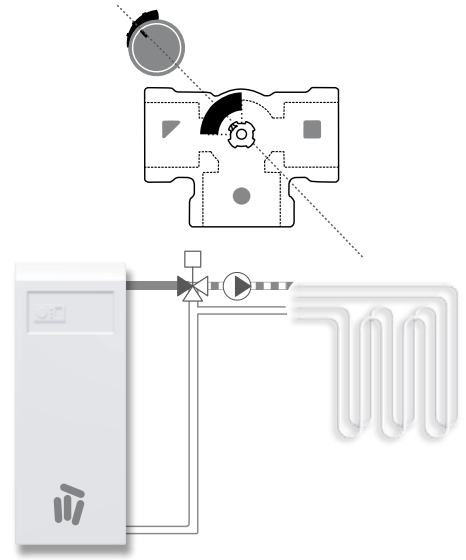

8b

