

ResiBoost

Variable Frequency Controller

Table of Contents

| | | |
|-------|--|----|
| 1 | Introduction and Safety..... | 3 |
| 1.1 | Introduction..... | 3 |
| 1.2 | Safety..... | 3 |
| 1.2.1 | Safety terminology and symbols..... | 3 |
| 1.2.2 | Spare parts..... | 4 |
| 1.2.3 | User safety..... | 4 |
| 1.2.4 | Protecting the environment..... | 5 |
| 2 | Transportation and Storage..... | 6 |
| 2.1 | Examine the delivery..... | 6 |
| 2.1.1 | Examine the package..... | 6 |
| 2.1.2 | Examine the unit..... | 6 |
| 2.2 | Transportation guidelines..... | 6 |
| 2.3 | Storage guidelines..... | 6 |
| 2.3.1 | Storage location..... | 6 |
| 3 | Product Description..... | 7 |
| 3.1 | Product overview..... | 7 |
| 3.2 | Technical data..... | 7 |
| 3.3 | Pump specifications..... | 8 |
| 4 | Installation..... | 9 |
| 4.1 | Electrical requirements..... | 9 |
| 4.2 | Mechanical installation..... | 9 |
| 4.3 | Hydraulic installation..... | 10 |
| 4.3.1 | Pressure tank installation..... | 12 |
| 4.3.2 | Components for correct installation..... | 12 |
| 4.4 | Electrical installation..... | 13 |
| 4.4.1 | Grounding (earthing)..... | 13 |
| 4.4.2 | Power supply connection..... | 13 |
| 4.4.3 | Low water input connection..... | 14 |
| 5 | System Description..... | 15 |
| 5.1 | User interface..... | 15 |
| 5.2 | Start-up and Initial Programming..... | 16 |
| 5.2.1 | Operating parameters..... | 17 |
| 5.2.2 | Counter and Alarm Log Menu..... | 17 |
| 5.3 | Programming..... | 18 |
| 5.3.1 | BASIC MENU (MB) parameters..... | 19 |
| 5.3.2 | ADVANCED MENU(MA) parameters..... | 21 |
| 5.4 | ART function (Automatic Reset Test)..... | 22 |
| 6 | Alarms and warnings..... | 23 |
| 6.1 | Alarms and warnings..... | 23 |
| 6.1.1 | Alarms and troubleshooting..... | 25 |
| 7 | System Setup and Operation..... | 30 |
| 7.1 | Parameters to check upon startup..... | 30 |
| 7.2 | Tank pressure..... | 30 |
| 7.3 | Pre-start checks..... | 30 |

| | |
|---|----|
| 7.4 Prime the pump..... | 31 |
| 7.4.1 Negative suction head pumps..... | 31 |
| 7.4.2 Positive suction head pumps..... | 31 |
| 7.5 Start the pump..... | 31 |
| 7.6 Change the direction of rotation..... | 31 |
| 7.7 Set the operating pressure..... | 32 |
| | |
| 8 Troubleshooting..... | 33 |
| 8.1 Faults, causes, and remedies..... | 33 |
| | |
| 9 Product Warranty..... | 35 |

1 Introduction and Safety

1.1 Introduction

Purpose of this manual

The purpose of this manual is to provide necessary information for:

- Installation
- Operation
- Maintenance



CAUTION:

Read this manual carefully before installing and using the product. Improper use of the product can cause personal injury and damage to property, and may void the warranty.

NOTICE:

Save this manual for future reference, and keep it readily available at the location of the unit.

1.2 Safety



WARNING:

- The operator must be aware of safety precautions to prevent physical injury.
- Operating, installing, or maintaining the unit in any way that is not covered in this manual could cause death, serious personal injury, or damage to the equipment. This includes any modification to the equipment or use of parts not provided by Xylem. If there is a question regarding the intended use of the equipment, please contact a Xylem representative before proceeding.
- Do not change the service application without the approval of an authorized Xylem representative.



CAUTION:

You must observe the instructions contained in this manual. Failure to do so could result in physical injury, damage, or delays.

1.2.1 Safety terminology and symbols



About safety messages

It is extremely important that you read, understand, and follow the safety messages and regulations carefully before handling the product. They are published to help prevent these hazards:

- Personal accidents and health problems
- Damage to the product and its surroundings
- Product malfunction



Hazard levels

| Hazard level | Indication |
|--|---|
|  DANGER: | A hazardous situation which, if not avoided, will result in death or serious injury |

| Hazard level | Indication |
|---|--|
|  WARNING: | A hazardous situation which, if not avoided, could result in death or serious injury |
|  CAUTION: | A hazardous situation which, if not avoided, could result in minor or moderate injury |
| NOTICE: | Notices are used when there is a risk of equipment damage or decreased performance, but not personal injury. |

Special symbols

Some hazard categories have specific symbols, as shown in the following table.

| Electrical hazard | Magnetic fields hazard |
|---|--|
|  Electrical Hazard: |  CAUTION: |

1.2.2 Spare parts



WARNING:

Only use original spare parts to replace any worn or faulty components. The use of unsuitable spare parts may cause malfunctions, damage, and injuries as well as void the guarantee.

For more information about the product's spare parts, refer to the Sales and Service department.

1.2.3 User safety

General safety rules

These safety rules apply:

- Always keep the work area clean.
- Pay attention to the risks presented by gas and vapors in the work area.
- Avoid all electrical dangers. Pay attention to the risks of electric shock or arc flash hazards.
- Always bear in mind the risk of drowning, electrical accidents, and burn injuries.

Safety equipment

Use safety equipment according to the company regulations. Use this safety equipment within the work area:

- Hard hat
- Safety goggles, preferably with side shields
- Protective shoes
- Protective gloves
- Gas mask
- Hearing protection
- First-aid kit
- Safety devices

NOTICE:

Never operate a unit unless safety devices are installed. Also see specific information about safety devices in other chapters of this manual.

Electrical connections

Electrical connections must be made by certified electricians in compliance with all international, national, state, and local regulations. For more information about requirements, see sections dealing specifically with electrical connections.

Precautions before work

Observe these safety precautions before you work with the product or are in connection with the product:

- Provide a suitable barrier around the work area, for example, a guard rail.
- Make sure that all safety guards are in place and secure.
- Make sure that you have a clear path of retreat.
- Make sure that the product cannot roll or fall over and injure people or damage property.
- Make sure that the lifting equipment is in good condition.
- Use a lifting harness, a safety line, and a breathing device as required.
- Allow all system and pump components to cool before you handle them.
- Make sure that the product has been thoroughly cleaned.
- Disconnect and lock out power before you service the pump.
- Check the explosion risk before you weld or use electric hand tools.

1.2.3.1 Wash the skin and eyes

Follow these procedures for chemicals or hazardous fluids that have come into contact with your eyes or your skin:

| Condition | Action |
|---------------------------------------|--|
| Chemicals or hazardous fluids in eyes | <ol style="list-style-type: none"> 1. Hold your eyelids apart forcibly with your fingers. 2. Rinse the eyes with eyewash or running water for at least 15 minutes. 3. Seek medical attention. |
| Chemicals or hazardous fluids on skin | <ol style="list-style-type: none"> 1. Remove contaminated clothing. 2. Wash the skin with soap and water for at least 1 minute. 3. Seek medical attention, if necessary. |

1.2.4 Protecting the environment**Emissions and waste disposal**

Observe the local regulations and codes regarding:

- Reporting of emissions to the appropriate authorities
- Sorting, recycling and disposal of solid or liquid waste
- Clean-up of spills

Exceptional sites**CAUTION: Radiation Hazard**

Do NOT send the product to Xylem if it has been exposed to nuclear radiation, unless Xylem has been informed and appropriate actions have been agreed upon.

Recycling guidelines

Always follow local laws and regulations regarding recycling.

2 Transportation and Storage

2.1 Examine the delivery

2.1.1 Examine the package

1. Examine the package for damaged or missing items upon delivery.
2. Record any damaged or missing items on the receipt and freight bill.
3. If anything is out of order, then file a claim with the shipping company.
If the product has been picked up at a distributor, make a claim directly to the distributor.

2.1.2 Examine the unit

1. Remove packing materials from the product.
Dispose of all packing materials in accordance with local regulations.
2. To determine whether any parts have been damaged or are missing, examine the product.
3. If applicable, unfasten the product by removing any screws, bolts, or straps.
Use care around nails and straps.
4. If there is any issue, then contact a sales representative.

2.2 Transportation guidelines

Precautions



WARNING:

- Observe accident prevention regulations in force.
 - Crush hazard. The unit and the components can be heavy. Use proper lifting methods and wear steel-toed shoes at all times.
-

Check the gross weight that is indicated on the package in order to select proper lifting equipment.

Position and fastening

The unit must be transported only in its horizontal position as indicated on the package. Make sure that the unit is securely fastened during transportation and cannot roll or fall over. The product must be transported at an ambient temperature from -10°C to 70°C (14°F to 158°F) with a non-condensing humidity of <95% and protected against dirt, heat source, and mechanical damage.

2.3 Storage guidelines

2.3.1 Storage location

NOTICE:

- Protect the product against humidity, dirt, heat sources, and mechanical damage.
 - The product must be stored at an ambient temperature between 10°C and 70°C (14°F and 158°F) and a non-condensing humidity below 95%.
 - The converter uses electrolytic capacitors which can deteriorate when not used for a long period of time. If storing for a year or more, make sure to run them occasionally to prevent deterioration.
-

3 Product Description

3.1 Product overview

ResiBoost™ is a variable frequency drive (controller) intended to be used with an electric pump for constant pressure systems.

Not suitable for drainage systems with/without level control.

A water system is only occasionally required to run at maximum capacity and the amount of water withdrawn varies over time.

ResiBoost™ automatically controls the speed of the electric pump while keeping the pressure in the system constant in relation to the signal of the pressure transducer (sensor) which is integral to the drive.



WARNING:

This product can expose you to chemicals including Lead, which is known to the State of California to cause cancer and birth defects or other reproductive harm. For more information go to: www.P65Warnings.ca.gov.

3.2 Technical data

| Model | Input Voltage (Vin) | Input Phase | Input Current (lin) | Breaker Size ¹ | Output Phase | Output Current (A) |
|----------|---------------------|-------------|---------------------|---------------------------|--------------|--------------------|
| RB111512 | 115V | 1 | 12.6 | 20A | 1 | 12 |
| RB12309 | 230V | 1 | 9.6 | 15A | 1 | 9 |
| RB32309 | 230V | 1 | 17.5 | 20A | 3 | 9.6 |

| | |
|--|--|
| Input voltage tolerance | Vin +/-10% |
| Rated voltage output (Vout) | RB1... 1x(0–100%)Vin RB3... 3x(0–100%)Vin |
| Rated input frequency | 50/60±2 Hz |
| Output frequency | 15–60 Hz |
| Overcurrent | 20%, 10 second maximum |
| Enclosure Rating | UL Type 3 (NEMA 3) |
| Setpoint pressure | 7 – 85 psi (0.5–5.86 bar) |
| Working Pressure (MWP) | 125 psi (8.6 bar) |
| Water flow rate | 0.13 – 66 GPM (0.5–250 l/min) |
| Ambient temperature | 32–122°F (0–50°C) |
| Maximum water temperature | 104°F (40°C) |
| Ambient humidity | < 50%, non-condensing |
| Pumped liquid | Water that is free of aggressive chemical substances and suspended solids. Not suitable for contact with glycol. |
| Elevation ² | ≤6561 ft (2000m) ASL |
| Digital input for float switch contact | 24Vdc, 23.9mA |

¹ Always follow national and local wiring codes.

² For higher altitudes or other environmental conditions not covered in this manual, contact customer service.

Table 1: Packaged systems data

| Packaged System Model | Drive Model | Volts | Hp | Max Output Amps | Pump Model | Motor Current Setting |
|-----------------------|-------------|-------|------|-----------------|--------------------|-----------------------|
| 13159RB115 | RB111512 | 115 | 1 | 12 | 3HM05N07M 6BBQE | 10.3 |
| 2294RB115 | RB111512 | 115 | 1 | 12 | 5HM03N07M 6BBQE | 10.3 |
| 13120RB230 | RB12309 | 230 | 0.75 | 9 | 3HM04N05M 6FBQE | 3.7 |
| 13150RB3 | RB32310 | 230 | 1 | 9.6 | 3HM05N07T 6PBQE | 3.5 |
| 22125RB230 | RB12309 | 230 | 1.5 | 9 | 5HM04N11M 6FBQE | 6.9 |
| 22157RB3 | RB32310 | 230 | 2 | 9.6 | 5HM05N15T 6PBQE | 6.5 |

Dimensions and weights

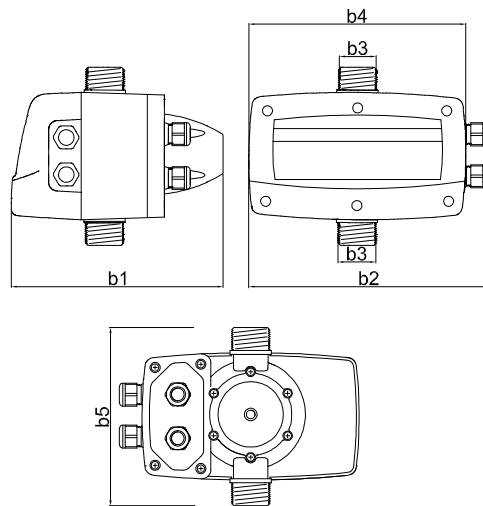

| Model | lbs. | b1 [in] | b2 [in] | b3 [in] | b4 [in] | b5 [in] |
|-------|------|---------|---------|-------------|---------|---------|
| RB1 | 6.4 | 9.1 | 10.4 | 1 1/4" MNPT | 9.4 | 7.7 |
| RB3 | | | | | | |

3.3 Pump specifications

Refer to the instruction manual of the pump. It is essential to consider the limitations of use of the controller together with those of the pump. See [Technical data](#) on page 7.

4 Installation

Precautions



WARNING:

- Observe accident prevention regulations in force.
 - Use suitable equipment and protection.
 - Always refer to the local and/or national regulations, legislation, and codes in force regarding the selection of the installation site, plumbing, and power connections.
-

4.1 Electrical requirements

- The local regulations in force overrule specified requirements listed in the following.

Electrical connection checklist

Check that the following requirements are met:

- The controller input and output cables are protected from high temperature, vibrations, and collisions.
- It is suggested to supply power to the controller by using a dedicated power line.
- The controller must be connected to a ground fault circuit interrupter (GFCI) breaker or receptacle.

NOTICE:

The electrical service panel must be compatible with the data of the pump and motor that is powered by the controller. Inappropriate combinations do not guarantee the protection of the unit and will void the warranty.

- The electrical service panel must give branch circuit overload protection to the controller and the pump against short circuit. Refer to [Technical data](#) on page 7 for breaker sizing.
- A time lag fuse which is inside the controller protects the system against short circuits.

4.2 Mechanical installation

NOTICE:

- Incorrect mechanical installation can cause the converter to malfunction and break.
 - Read this manual and the one for the electric pump before installation.
-

Check that the following are adhered to:

- Proper orientation of the controller is upright and perpendicular to pump and motor.
- The controller must be full of water in order to work and read the pressure correctly.
- Do not install the controller in an area exposed to direct sunlight and/or near heat sources. Refer to the ambient temperature range in the technical data section.
- Install the controller and pump in dry, frost-free conditions, observing the limitations of use and guaranteeing sufficient cooling of the motor.
- Do not use the product in explosive atmospheres or in the presence of corrosive and/or flammable dust, acid, or gas.
- Do not use the controller and the electric pump to handle hazardous or flammable liquid.
- ResiBoost package has minimal lift capabilities. It is preferred to use on a flooded suction. If a lift is required, be sure that suction piping is used with a minimum size to match the suction port of the pump and with minimum fittings to reduce losses.

**WARNING:**

Do NOT install this pump in swimming pools or marine areas. Failure to follow these instructions could result in serious personal injury, death and/or property damage.

**CAUTION: Electrical Hazard**

Risk of electrical shock or burn. The equipment manufacturer has not evaluated this unit for use in swimming pools. If used in connection with swimming pools then special safety regulations apply.

4.3 Hydraulic installation

**WARNING:**

The pump should not be installed without provisions for adequate drainage in the event of leakage. Failure to provide adequate drainage could result in property damage.

Refer to [Figure 2: Repressurizing Water System Configuration](#) on page 12 and [Figure 3: Municipal Water Configuration](#) on page 12 in [Components for correct installation](#) on page 12 for more information about the required components for correct piping in desired applications.

- Suction piping should be no smaller than the suction connection on the pump. Keep suction piping as short and direct as possible. Avoid multiple elbows and unnecessary fittings to minimize friction loss. Refer to the pump manual to ensure that the NPSHr is maintained.
- To avoid air pockets, no part of the suction piping should be above the pump suction connection. Suction piping should slope upward from the liquid source to the pump suction.
- In cases where the water level is below the suction of the pump (lifting water), install a check valve (foot valve) on the suction of the pump to make sure that the pump stays primed.
 - The ResiBoost Package configuration (with eHM pump) is supplied with a multistage pump and NOT recommended for priming applications.
- Install a gate valve to allow maintenance of the controller and pump or of the pressure tank.

Check that the following are adhered to:

- Install a Check Valve between the pump discharge and the controller if not supplied with assembled unit. (ResiBoost Package with eHM model pump includes a union check valve in the assembly. Part number: 15K112)
- If the supplied union check valve is uncoupled, secure the controller to the pump by hand tightening the union. **Do not over-tighten the union with the use of tools.**
- A pressure drop results because of the flow through the controller. Be sure to deduct the Pressure Drop Through Controller from the head pressure of the pump.

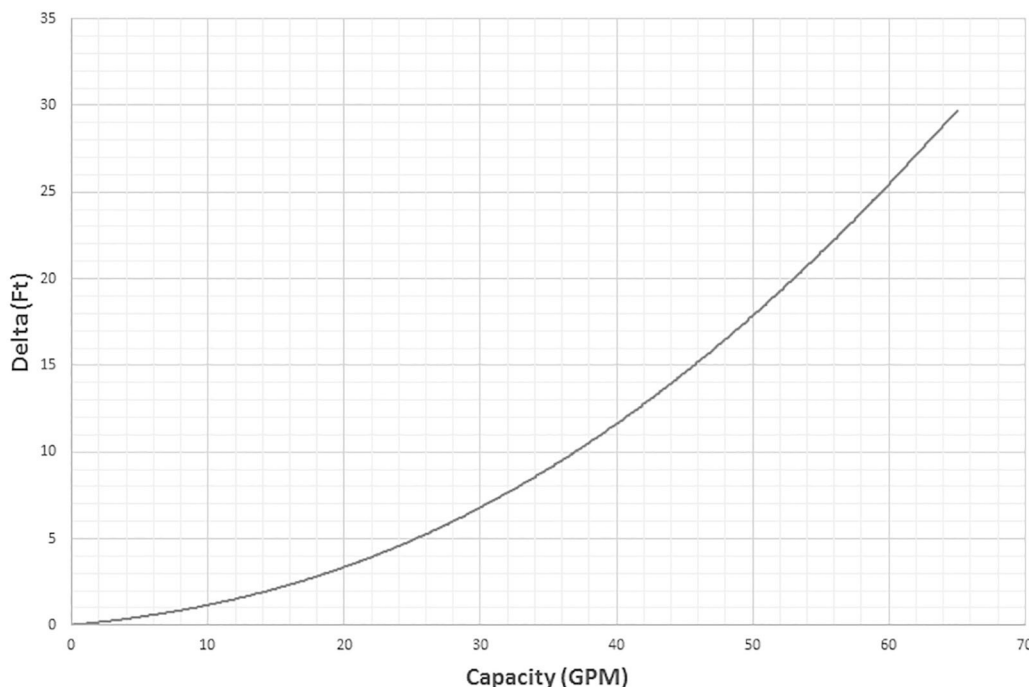

Figure 1: Pressure Drop Through Controller

- Install a pressure relief valve sufficient to limit the system pressure below the maximum working pressure of the pump and tank (the minimum of the two). The pressure relief valve must be plumbed to a drain to prevent damage due to flooding.
- Check that the sum of the pressure intake (for example, for the connection with a municipal line or pressure tank) and the maximum pressure of the pump does not exceed the value of the maximum permitted operating pressure of the controller or of the pump (the minimum of the two).
- All piping **MUST** be independently supported. **DO NOT** place any piping loads on the pump or controller.



CAUTION:

When connecting the pump to controller only hand tighten the union nut. Do **NOT** USE a wrench when tightening. Do not further tighten the pipe connections. Over-tightening and the use of wrenches can cause the fittings to fail.

- If a realignment of the control is desired, loosen the union nut on the adapter fitting and rotate to the position desired. Re-tighten the union by hand. The O ring inside the union provides a leak tight seal without the use of tools. The use of tools may damage the unit.



CAUTION:

Do not allow any of the connections on the control or pump to turn when re-tightening the union.

- It is advisable to install a tap for use during commissioning of the system if there is not already an outlet near the pump.
- The controller plus electric pump can be used to connect the system directly to the municipal supply line or to take water from a primary water supply tank.
 - If connecting to a municipal supply, follow the applicable provisions set by the authorities having jurisdiction.
 - If connecting to a municipal supply, install a bypass loop to allow servicing of the pump and controller without turning off the municipal supply.

- It is advisable to install a pressure switch on the suction side for turning off the pump if there is low pressure in the in-coming supply line. Protects against dry running.
- If connecting to a primary water supply tank, it is advisable to install a float for turning off the pump when there is no water. Protects against dry running. In this application ResiBoost package with eHM model multistage pump must be installed with minimum fittings to reduce suction losses.
- Refer to the instruction manual of the pump for further information.

4.3.1 Pressure tank installation

- A diaphragm tank must be installed on the discharge side of the controller (See [Components for correct installation](#) on page 12). The tank that is included with the assembled ResiBoost Package with eHM model is a 2 Liter tank. This tank is the minimum size needed for stable operation in most applications. Some applications may require a larger tank.
- Set the air pressure (pre-charge) in the tank with the tank empty of water. Pre-charge must be adjusted to be 20 psi below the Pressure Setpoint (5P) based on 5 psi pressure drop.



WARNING:

- Make sure the pressure tank can withstand the maximum pressure of the system.
- Install a pressure relief valve large enough to limit the system pressure below the maximum working pressure of the tank and controller. Plumb the pressure relief valve to a drain to prevent damage due to flooding.

4.3.2 Components for correct installation

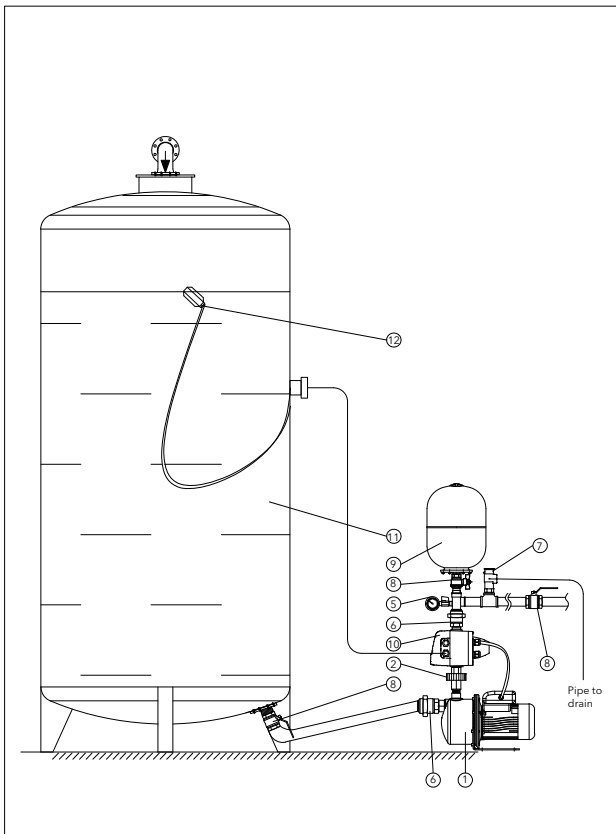

Figure 2: Repressurizing Water System Configuration

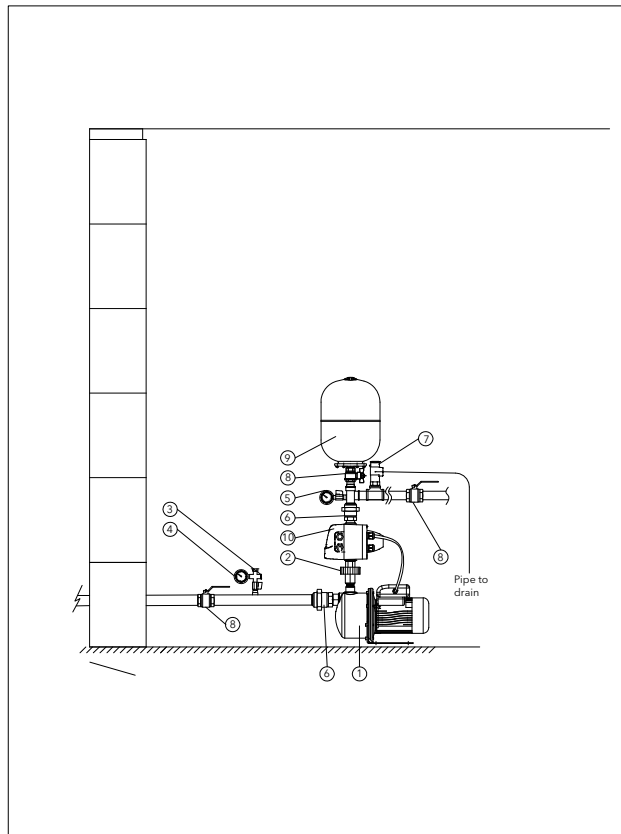

Figure 3: Municipal Water Configuration

| Number | Component | Included in the kit | Notes |
|--------|---------------|---------------------|-------|
| 1 | Electric pump | √ | eHM |

| Number | Component | Included in the kit | Notes |
|--------|-----------------------------------|---------------------|---------------------|
| 2 | Union with check valve | √ | |
| 3 | Electric pump bleed / priming cap | | |
| 4 | Vacuum pressure gauge | | |
| 5 | Discharge pressure gauge | | |
| 6 | Union | | |
| 7 | Pressure relief valve | | Plumb to drain |
| 8 | Gate valve | | |
| 9 | Diaphragm tank | √ | V2L (2 liter tank) |
| 10 | ResiBoost controller | √ | |
| 11 | Storage tank | | |
| 12 | Float switch | | |

For lifting applications consult Customer Service for recommendations.

4.4 Electrical installation

Precautions

NOTICE:

- Make sure that all electrical connections are performed by qualified installation technicians and in compliance with the regulations in force.
 - Before starting work on the unit, make sure that the unit and the control panel are isolated from the power supply and cannot be energized.
 - Make sure all plumbing connections are made prior to wiring the unit.
-

4.4.1 Grounding (earthing)



Electrical Hazard:

Always connect the ground (earth) connection before making other electrical connections.

4.4.2 Power supply connection



WARNING:

Always turn off the power supply, lockout power and wait a minimum of 2 minutes before making any electrical connections.

The controller comes with an input power cable and a motor power cable to allow flexibility in positioning the controller. After plumbing the system, position the controller for access to the user interface.

NOTE: The controller must be connected to a GFCI. Use either a GFCI circuit breaker or GFCI outlet.

115 V models are supplied with an input power supply cable with NEMA 5-15 plug. Connect the plug to a NEMA 5-20 GFCI receptacle. 230V models are supplied with an input power supply cable with a NEMA 6-20 plug. Connect the plug on 230V models to a NEMA 6-20 GFCI receptacle. The receptacle must be protected by a circuit breaker. Refer to [Technical data](#) on page 7 for circuit breaker sizing. The receptacle must be wired and installed according to the environmental conditions of the installation. Install the system making sure that the plug and socket can be easily accessed for deactivating the system.

Do not attempt to replace the power cables included with the controller. All models must be connected to a dedicated circuit. The receptacle must be installed to comply with the environmental conditions of the installation. All wiring must comply with the NEC, CEC and authority having jurisdiction. The power cable of the motor must NEVER be laid parallel to the power cable of the controller. Do not route the wires feeding the receptacle in parallel with other wires for more than 12".

Although the controller has a single-phase power supply, some models have a 3 phase 230V pump motor. The missing phases are created by the controller.

4.4.3 Low water input connection

The Low Water Input allows connection of a pressure or float switch which is used to start and stop the pump. When the input is enabled, the pump will run when the input is closed. The controller will stop the pump and issue an $R \downarrow$ alarm when the input is open.

1. Turn off power and wait 5 minutes.
2. Unfasten the 6 screws and open the FRONT cover.

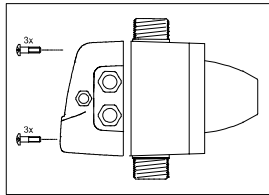

Figure 4

3. If required, connect the cable of the level switch or pressure switch to the digital input to prevent dry running of the pump. The electrical contact must be normally open when an alarm is triggered. Use 2 conductor, 18 to 14AWG cable will fit in terminals for input. Tighten terminals to 4 in-lb.
4. Insert the cable in the cable gland in the cover.

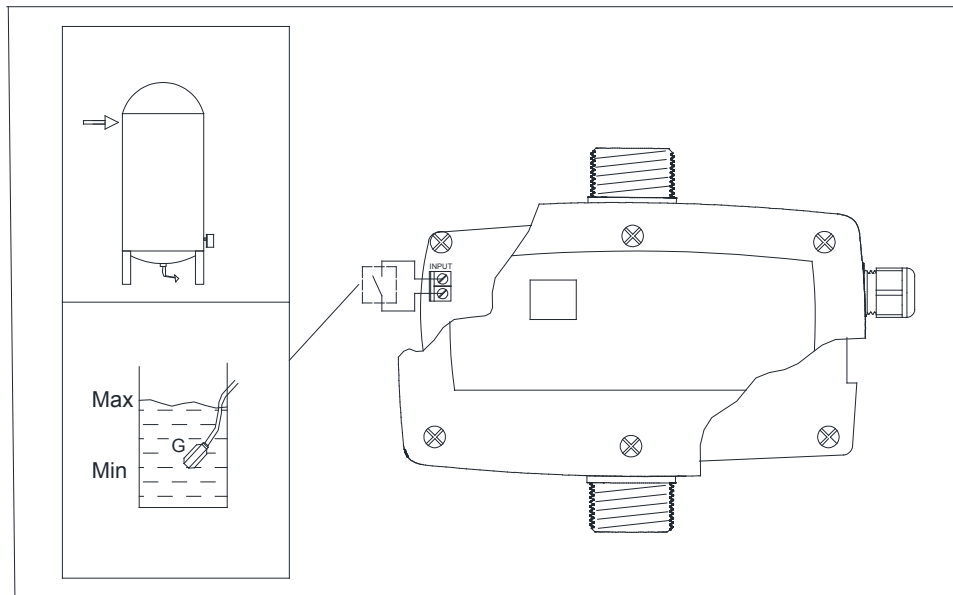

Figure 5

5. Check that all the cables are secure and close the FRONT cover, making sure not to crush the cables between the cover and the controller housing. Fasten the 6 cover screws. Tighten to 17.7 in-lb.

5 System Description

5.1 User interface

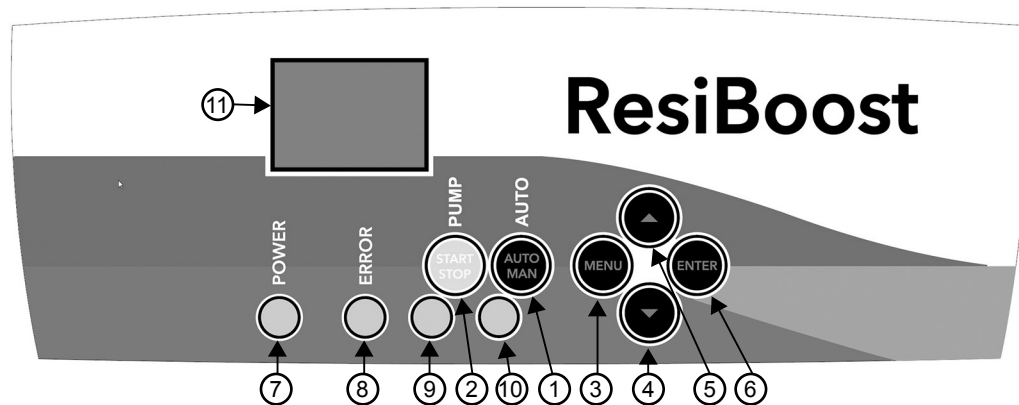

Figure 6: User interface

| Number | Description |
|---------|--|
| 1 | This button is used to switch between AUTOMATIC and MANUAL Mode. In AUTOMATIC Mode, the controller operates the pump to maintain the pressure setpoint. In MANUAL Mode, the controller operates the pump based on the Start/Stop button. |
| 2 | This button is used for the Start/Stop function. In MANUAL Mode: To run the pump, press and hold the button. The pump ramps down to stop when the button is released. In AUTOMATIC Mode: Press to exit AUTOMATIC mode and enter MANUAL mode. If the pump is running, it ramps to stop. |
| 3 | This button is used to access the BASIC MENU parameters in MANUAL mode. See BASIC MENU (MB) parameters on page 12. |
| 4 and 5 | These two buttons are used for: <ul style="list-style-type: none"> Decreasing or increasing the value of a parameter that is selected in the BASIC MENU (MB) or ADVANCED MENU (MA). Viewing the operating parameters in AUTOMATIC mode. See operating parameters on page 10. |
| 6 | This button is used for saving and selecting the next parameter in any MENU. In MANUAL mode, this button is an alarm reset button. |
| 7 | Power LED: Steady green LED, indicates the power is on and the controller is active. |
| 8 | Error LED: Steady red LED, indicates a fault. The LED is illuminated when there is an alarm. |
| 9 | Start/Stop LED: Steady yellow LED, indicates the pump is running. |

| Number | Description |
|--------|--|
| 10 | Mode LED: <ul style="list-style-type: none"> • Illuminated green and steady in Automatic mode. • Flashing green in manual parameter configuration mode (Basic Menu, Advanced Menu) |
| 11 | Display for showing operating parameter, menu parameters, or fault codes. |













5.2 Start-up and Initial Programming



Refer to [Figure 6: User interface](#) on page 15 for an explanation of the buttons on the user interface.

1. Check that all the electrical, mechanical, and hydraulic connections have been made. See [Mechanical installation](#) on page 9, [Hydraulic installation](#) on page 10, and [Electrical installation](#) on page 13.
2. Turn on the power to the controller.
 - All the LEDs (7) (8) (9) (10) turn on and, if there are no faults, turn off again within 10 seconds.
 - The controller performs an autotest and the Power LED (7) turns on.
 - The display shows the software version.

NOTICE:

- The controller enters MANUAL mode upon initial start-up. The mode at power-up is the same one the controller was in when it was previously turned off.
- After turning off power to the controller, wait a minimum of 20 seconds before applying power. This procedure is to prevent the risk of internal damage to the controller.

3. Enter the BASIC MENU to set the pressure setting.
 - If the controller is not in MANUAL Mode, switch to MANUAL mode by pressing (2) ; in MANUAL mode the Mode LED (10) is off.
 - In MANUAL mode, press and hold (3)  for 3 seconds until the first parameter to be edited appears on the display and the Mode LED (10) flashes.
 - The display toggles between \mathbf{R} (Motor Current setting) and a number. Make sure that the number matches the current rating on the motor nameplate. This value is preset from the factory for packaged systems. Press (4)  or (5)  to change the value of the parameter, then press (6)  to save the setting and select the next parameter.
 - Press (6)  until the Pressure Setpoint ($5P$) is reached. Press (4)  or (5)  to edit the Pressure Setpoint, then press (6)  to save the setting.
 - Press (6)  until the Pressure Drop (dP) is reached. When in Standby mode, the controller starts the pump when the system pressure is less than the Pressure Drop value. Set the Pressure Drop value as a percentage of the Pressure Setpoint. For example, if the Pressure Setpoint is 50 psi and the desired pressure drop is 5 psi, set the dP value to 90. Press (4)  or (5)  to edit, press (6)  to save.

- Press (3)  to exit the BASIC MENU.
- Press (1)  to enter AUTOMATIC Mode and Mode LED (10) is steady green.

NOTICE:

- In AUTOMATIC mode, the pump runs if the pressure of the system is below the Pressure Drop (dP) value.

- If necessary, press (2)  to set MANUAL mode and turn off the pump.

5.2.1 Operating parameters

Refer to [Figure 6: User interface](#) on page 15 for an explanation of the buttons on the user interface.

In AUTOMATIC mode, press (4)  or (5)  to change the Operating Parameter being displayed.

Table 2: Operating parameters

| Parameter | Description | Unit | Range |
|------------|---------------------------------|---------------------------------|------------|
| P | System pressure | PSI | 0.0–99 |
| F_r | Motor Frequency | Hz | Min–60 |
| I | Output Current | Ampere | 0– I_n^3 |
| θ_c | Temperature of the power module | Degrees Celsius ($^{\circ}C$) | 0–80 |

The last parameter to be selected is shown continuously on the display.

5.2.2 Counter and Alarm Log Menu

Refer to [Figure 6: User interface](#) on page 15 for an explanation of the buttons on the user interface.

In MANUAL Mode, in addition to the parameters indicated in [Operating parameters](#) on page 17, it is possible to view the Counter and Alarm Log.

To access this menu, press and hold (3)  and (5)  at the same time for three seconds.



Press (6)  to select the next parameter. The parameters will be displayed in the sequence shown in the following table. The menu will exit after the R_3 parameter or press (3)  to exit the menu.

Table 3: Counter and Alarm Log Menu Parameters

| Parameter | Description |
|----------------|---|
| H _F | Number of hours the controller has been powered. |
| H _P | Number of hours the motor has been running. |
| ΣF | Number of times the pump has turned on and off. |
| Σr | Number of times the controller has been turned off. |

³ Maximum current supplied to the motor (refer to [Technical data](#) on page 7).

| Parameter | Description |
|-----------|---|
| R1 | Total number of times the digital input has triggered the R1 (No Water) alarm has been triggered.. |
| R2 | Total number of times the R2 (Overcurrent) alarm has been triggered. |
| R3 | Total number of times the R3 (Open Lead) alarm has been triggered. |
| R4 | Total number of times the R4 (Minimum Pressure) alarm has been triggered. |
| R5 | Total number of times the R5 (Pressure Sensor Fault) alarm has been triggered. |
| R6 | Total number of times the R6 (Over Temperature) alarm has been triggered. |
| R7 | Total number of times the R7 (Short Circuit) alarm has been triggered. |
| R8 | Total number of times the R8 (Overvoltage) alarm has been triggered. |
| R9 | Total number of times the R9 (Undervoltage) alarm has been triggered. |

Press (6)  to view values greater than 99.

Example:

Total operating hours HF = 1250.

 +  +  +  +  +  ...

Figure 7: Total operating hours

Total alarm R2 = 102.

...  +  +  +  +  +  +  +  +  ...

Figure 8: Total alarm

RESET LOGS: Scroll to R9 log and then press. and hold (4)  to exit the menu. This resets the counter and alarm log.

5.3 Programming

The controller has two parameter menus that are accessed with a combination of keys:

- BASIC MENU (MB)
- ADVANCED MENU (MA)

NOTICE:

- The controller is delivered already programmed with the default values. Edit the values according to the type of pump and system.
- If the controller was supplied from the factory with a pump, it has been programmed at the factory for operation with the pump.
- Incorrect configuration can damage the pump, motor and/or system.

5.3.1 BASIC MENU (MB) parameters

Refer to [Figure 6: User interface](#) on page 15 for an explanation of the buttons on the user interface.

Use the steps below to enter and navigate the BASIC MENU.







- Press (2)  to enter MANUAL mode.
- Press and hold (3)  for 3 seconds to access The BASIC MENU (MB). The Mode LED (10) flashes.
- Press (4)  or (5)  to edit the value of the parameter.
- The parameters will be displayed in the sequence shown in the following table.
- Press (6)  to save and move on to the next parameter.
- The menu will exit after the last parameter or if (3)  is pressed. The Mode LED (10) turns off after exiting the menu.

Table 4: MB Parameter description

| Parameter | Description | Range | Unit | Default |
|-----------|--|---------------------------------------|--------|-------------------|
| R | Motor Current Setting - Set the current rating to the value on the motor nameplate. ⁴ WARNING: If the Motor Current Setting is not configured correctly, the motor might NOT be protected against overload and which can result in damage. | 0.1–Imax | Ampere | Imax ⁵ |
| FL | Minimum Frequency – start and stop frequency of the motor. In AUTOMATIC mode, the controller stops the pump and enters standby when the minimum frequency is reached. | 20–45 (RB1) 15–45 (RB3) | Hz | 30 |
| EL | Enable for the Low water digital input - Connect a non-powered switch to the input, for example a pressure or float switch. Alarm R ! (No Water) will be issued if parameter EL =1 and the switch is open. | 0: Disabled, no control 1: Enabled | - | 0 |
| SP | Pressure Setpoint – target value for pressure control. | 7.25 - 85 | PSI | 60 |

⁴ Imax: maximum current supplied. The value varies according to the model of controller.

| Parameter | Description | Range | Unit | Default |
|-----------|--|-----------------------------------|------|---------|
| ΠP | Minimum Pressure Setting - an $R4$ alarm (Minimum Pressure) is triggered when the system pressure drops below the ΠP value for longer than the time set in dL (Minimum Pressure Delay Timer). When the alarm is triggered, the pump stops and the ART function is enabled. See ART function (Automatic Reset Test) on page 22. Set to 0.0 to disable. | 0.0–($5P$ -6.0) 0.0: Disabled | PSI | 0.0 |
| dL | Minimum Pressure Delay Timer – delay timer for triggering of the $R4$ (Minimum Pressure) alarm. | 0–99 | sec | 20 |
| $r5$ | Reverse Motor Rotation - For RB3 models, reverse the direction of motor rotation. 0=no action 1=reverse the direction of rotation | 0–1 | - | 0 |
| dP | Pressure Drop - This parameter is the value for starting the pump after a stop, calculated as a percentage of the Pressure Setpoint ($5P$) value. For example: $5P = 60$ psi $dP = 90$ % The controller will restart the pump when the pressure drops below 54 psi. | 0–99 | % | 90 |

| Parameter | Description | Range | Unit | Default |
|-----------|--|-------|------|---------|
| d_r | <p>Dry Run Limit - This parameter sets the percentage of Motor Current Setting (R) below which will trigger an R I (No Water) alarm. For example, if the value of R is set to 10A and the value of d_r is set to 65%, then an R I alarm will be triggered if the output current falls below 6.5A while the pump is running at full speed. Raise the Dry Run Limit to trigger an R I alarm at a higher output current. Lower the Dry Run Limit if nuisance tripping of an R I alarm results.</p> <p>Notice: Setting the Dry Run Limit too low will disable the R I alarm. Disabling the alarm can allow the pump to become damaged during an adverse condition.</p> | 10–80 | % | 65 |

5.3.2 ADVANCED MENU(MA) parameters

Refer to [Figure 6: User interface](#) on page 15 for an explanation of the buttons on the user interface.

Follow these steps to enter and navigate the ADVANCED MENU.







1. Press (2)  to enter MANUAL mode.
2. Press and hold (3)  and (6)  at the same time for a few seconds. The Mode LED (10) flashes.
3. Press (4)  or (5)  to edit the value of the parameter.
4. Press (6)  to save and move on to the next parameter.
5. The menu will exit after the last parameter or if (3)  is pressed. The Mode LED (10) turns off after exiting the menu.

Table 5: MA Parameter description

| Parameter | Description | Range | Unit | Default |
|-----------|---|-------------------|--------|---------|
| P_r | Proportional Gain – sets the proportional gain for the pressure control loop. Increasing the value causes the controller to respond faster to the difference between the actual and setpoint pressure. Setting the value too high can cause oscillations. | 01–40 | N | 20 |
| R_c | Acceleration Time - Minimum time required for the frequency of the motor to go from minimum to maximum frequency. | 01–20 | Hz/sec | 10 |
| d_c | Deceleration Time - Minimum time required for the frequency of the motor to go from maximum to minimum frequency. | 01–20 | Hz/sec | 10 |
| L_d | Load Defaults - Select 1 to set the all parameters to default. | 0 = no 1 = yes | | |

NOTICE:

Editing the parameters can cause the controller to malfunction. Contact service at 844–995–7867 for assistance.

(*) these values depend on the type of installation and are compatible with all the various types of system.

5.4 ART function (Automatic Reset Test)

The R_1 **No Water** and R_4 **Minimum Pressure** alarms reset according to the Automatic Reset Test (ART) function.

When either alarm is triggered with the Error LED (8) illuminated, the controller does an automatic reset test. For the first instance of the alarm, the controller will restart the pump after 5 minutes. If the alarm triggers again, the controller attempts to restart the pump after 30 minutes. If the alarm continues, the controller attempts to restart the pump every 30 minutes over the next 24 hours.

If the alarm continues after these attempts, the controller stays locked out and requires a manual alarm reset of the alarm to restart the pump. During the ART attempts, it is possible to reset the alarm as indicated in *Alarms and warnings* on page 23.

To disable the ART function, it is necessary to disable the MINIMUM PRESSURE function by setting P_P (**Minimum Pressure Setting**) to 0.0.

6 Alarms and warnings

When an alarm is triggered or the pump is locked, the fault LED (8) is illuminated and steady and the electric pump is at standstill.



WARNING:

In this case, the system is in AUTOMATIC mode. If the converter is turned off and on again, it runs in AUTOMATIC mode.

The last alarm is shown on the display. It is possible for several alarms to be triggered at the same time.

To start the pump:

1. Press (2) to enter MANUAL mode.
 2. Press (5) to view the types of faults in progress, if there is more than one.
 3. Eliminate the cause of the faults.
 4. Press (6) to reset the system (alarms) and the LED (8) turns off.
 5. Press (2) to set AUTOMATIC mode and the pump starts up if the pressure of the system is below the set point. This resets the alarms and, if an alarm is still active, the LED (8) is illuminated and the pump is still locked. Repeat steps 1–5.
-



WARNING:

- Alarm **A1** no water and **A4** minimum pressure are not available in manual mode and it is possible to press (1) to run the pump.
 - Alarms **A3, A5, A6, A7, A8, A9** are available in MANUAL mode and when an alarm is triggered, the LED (8) is illuminated and the pump cannot be started by pressing (1).
 - Alarm **A2**: if the system is in manual mode and (1) has been pressed to run the pump, the pump stops and the LED (8) is illuminated when the absorbed current exceeds the set value.
-

6.1 Alarms and warnings

Refer to [Figure 6: User interface](#) on page 15 for an explanation of the buttons on the user interface.

When an alarm is triggered or the controller is locked, the fault LED (8) is illuminated and steady and the pump is stopped.





WARNING:



If the controller is in AUTOMATIC mode and is turned off and on again, it will power up in AUTOMATIC mode and can start the pump.

The last alarm is shown on the display. It is possible for several alarms to be triggered at the same time.

Manual Alarm reset

To manually reset an alarm and start the pump:

1. Press (2)  to enter MANUAL mode.
2. Press (4)  or (5)  to view the types of alarms in progress, if there is more than one.
3. Eliminate the cause of the alarms.

4. Press (6)  to reset the alarms. The Error LED (8) will turn off when the alarm is reset.
5. Press (1)  to return to AUTOMATIC mode. The controller will then operate the pump based on settings and system conditions.



WARNING:

- Alarm R1 (No Water) and R4 (Minimum Pressure) are not available in MANUAL mode. In MANUAL mode it is possible to run the pump without protection.
- Alarms R2, R3, R5, R6, R7, R8, R9 are available in MANUAL mode and when an alarm is triggered, the Error LED (8) is illuminated and the pump cannot be started by pressing (2)



6.1.1 Alarms and troubleshooting

| Alarm Code | Alarm Name | Description |
|------------|--|---|
| | Controller Reaction | This information is to be used by professional installers or qualified personnel only. |
| R1 | <p>No Water/Loss of Prime/Dry Pump</p> <p>The controller will attempt to restart the pump according to the ART function.</p> | <p>This alarm can be caused by:</p> <ul style="list-style-type: none"> • Plugged suction pipe or screen. • Pump running against a closed valve. • Restriction in pipe/pump. • Air bound pump. • Gas entrained water with entrained air (ResiBoost packages with eHM model pumps have to be fully primed with minimum suction losses from piping in order to avoid nuisance A1 trips.) • Pump lost prime or is not primed. • Incorrect setting of MOTOR CURRENT SETTING in the BASIC MENU. Ensure the MOTOR CURRENT SETTING is not set higher than the Service Factor Amps (SFA) listed on the motor nameplate. • The EL parameter is enabled and the digital input is open. See BASIC MENU (MB) parameters on page 19. <p>This alarm will trigger if the following conditions are true:</p> <ul style="list-style-type: none"> • Motor is running at full speed • Output current is lower than the value set by the dr parameter See BASIC MENU (MB) parameters on page 19. • Or if: The EL parameter is enabled and the digital input is open. <p>If nuisance tripping continues after adequate water supply has been verified:</p> <ul style="list-style-type: none"> • Verify the MOTOR CURRENT SETTING • Verify operation of float/pressure switch if EL parameter is enabled. • For single phase motors, verify the motor thermal protector did not trip. • Lower the value of the dr parameter. • Measure the maximum possible output current for the system. Set the MOTOR CURRENT SETTING according to this value instead of motor SFA. |

| Alarm Code | Alarm Name | Description |
|------------|--|--|
| | Controller Reaction | This information is to be used by professional installers or qualified personnel only. |
| R2 | <p>Overcurrent</p> <p>The controller will attempt to restart the pump 3 times. After the 4th trip, the controller will require a manual alarm reset. Each subsequent trip takes longer to reset.</p> | <p>This alarm can be caused by:</p> <ul style="list-style-type: none"> • Using wrong motor (wrong voltage or phase). • Mechanical binding from debris in pump. • Electrical or mechanical failure of the motor. • Incorrect setting of "MOTOR CURRENT SETTING" in the BASIC MENU. The controller will issue an Overcurrent alarm if the setting is too low. <p>The alarm will trigger if:</p> <ul style="list-style-type: none"> • The motor current is greater than 120% of the MOTOR CURRENT SETTING. The time to trip will vary based on the severity of the overload condition. The controller will attempt to restart the motor up to 3 times. The time between restarts will vary based on the severity of the overload and the number of overloads recorded by the controller. Each subsequent trip has a longer reset time. If the Error LED is flashing, the controller will attempt to restart. If the Error LED is constant red, the controller requires a manual alarm reset. The controller may not immediately restart the pump/motor when the power is restored. If power is interrupted, the controller will remember the state of the Overcurrent function. <p>If the fault persists:</p> <ul style="list-style-type: none"> • Verify the MOTOR CURRENT SETTING • Check the motor and pump for damage or failure • Check electrical connections to the motor. |
| R3 | <p>Open Lead</p> <p>A manual alarm reset is required.</p> | <p>This alarm can be caused by:</p> <ul style="list-style-type: none"> • Damaged motor cable. • Damaged or bad connection to motor. • Motor failure. • Internal fuse of controller is open • For single phase motors, motor thermal protector trip. <p>The alarm is triggered if:</p> <ul style="list-style-type: none"> • The current to the motor reaches 0 while the controller is operating the motor. A manual alarm reset is needed to restart the pump. <p>If the alarm persists:</p> <ul style="list-style-type: none"> • Check all connections to the motor • Electrically test the motor • For single phase motors, check the thermal protector |

| Alarm Code | Alarm Name | Description |
|------------|---|--|
| | Controller Reaction | This information is to be used by professional installers or qualified personnel only. |
| R4 | <p>Minimum Pressure</p> <p>The controller will attempt to restart the pump according to the ART function.</p> | <p>This alarm can be caused by:</p> <ul style="list-style-type: none"> The system pressure has dropped below the \overline{P} setting for longer than the time set in the dL parameter. The \overline{P} and dL parameters are set in the BASIC MENU. Refer to BASIC MENU (MB) parameters on page 19 for details on accessing the BASIC MENU. The controller will attempt to restart the pump according to the ART function. See ART function (Automatic Reset Test) on page 22. <p>If the alarm occurs unexpectedly:</p> <ul style="list-style-type: none"> Check the water supply to the pump Check the system NPSHa and that the pump is properly sized for the system Adjust the \overline{P} and dL parameters based on the system conditions Check that the pump is primed. <p>If the alarm persists:</p> <ul style="list-style-type: none"> Check for a damaged pump Check for leaks in the suction piping |
| R5 | <p>Pressure Sensor Fault</p> <p>The controller will not restart.</p> | <p>This alarm can be caused by:</p> <ul style="list-style-type: none"> An issue with the internal pressure sensor. This can be an issue with the sensor itself or connections between the sensor internal control board. The internal pressure sensor is not repairable. <p>If the alarm occurs:</p> <ul style="list-style-type: none"> Reset the alarm by following the procedure in Alarms and warnings on page 23. Turn off power to the controller. Wait 2 minutes for the electrical energy to discharge. Turn on power to the controller. <p>If the alarm persists:</p> <ul style="list-style-type: none"> Contact customer service. |

| Alarm Code | Alarm Name | Description |
|------------|---|---|
| R6 | <p>Controller Reaction</p> <p>Over Temperature The controller will reset when the temperature of the power module reaches the valid range.</p> | <p>This information is to be used by professional installers or qualified personnel only.</p> <p>This alarm is caused by:</p> <ul style="list-style-type: none"> • Overheating of the power module • Ambient temperature exceeds 122°F (50°C) • Water temperature exceeds 104°F (40°C) • Faulty power module <p>If the alarm occurs:</p> <ul style="list-style-type: none"> • Verify the ambient temperature does not exceed 122°F (50°C) • Verify the water temperature does not exceed 104°F (40°C) • Verify the installation is not exposed to direct sunlight • Scroll through the Operating Parameters and verify the temperature of the power module. The controller issues the alarm at or above 80°C. The controller will attempt to restart the pump below 60°C. <p>If the alarm persists:</p> <ul style="list-style-type: none"> • Contact customer service. |
| R7 | <p>Short Circuit The controller will attempt to restart the pump 3 times. After the fourth trip, the controller will require a manual alarm reset. Each subsequent trip takes longer to reset.</p> | <div style="display: flex; align-items: center;">  <div> <p>WARNING: Repeated exposure to Short Circuit conditions can damage the controller. Do not reset this fault without fixing the short circuit condition more than twice.</p> </div> </div> <hr style="width: 20%; margin-left: auto; margin-right: 0;"/> <p>This fault can be caused by:</p> <ul style="list-style-type: none"> • Mechanical binding from debris in pump. • Electrical failure of the motor. • Electrical failure of wiring between controller and motor. <p>If the alarm occurs:</p> <ul style="list-style-type: none"> • The controller will attempt to restart the motor up to 3 times. The time between restarts will vary based on the severity of the overload and the number of overloads recorded by the controller. Each subsequent trip has a longer reset time. If the Error LED is flashing, the controller will attempt to restart. If the Error LED is constant red, the controller requires a manual alarm reset. • Reset the alarm by following the procedure in Alarms and warnings on page 23. • Turn off power to the controller. Wait 2 minutes for the electrical energy to discharge. • Turn on power to the controller and see if alarm persists. • Check the motor wiring • Check the motor for shorting phase to phase and phase to ground. Refer to motor's manual for information on resistance readings. <p>If the alarm persists:</p> <ul style="list-style-type: none"> • Contact customer service. |

| Alarm Code | Alarm Name | Description |
|------------|---|--|
| | Controller Reaction | This information is to be used by professional installers or qualified personnel only. |
| R8 | <p>Over Voltage</p> <p>The controller will restart when the input voltage is within the valid range.</p> | <p>This fault can be caused by:</p> <ul style="list-style-type: none"> • The controller detected a high input voltage. • The Deceleration Time (t_d in the ADVANCED Menu) is too fast. • A check valve in the system is faulty causing the motor to rotate and generate voltage back to the controller. <p>If the alarm occurs:</p> <ul style="list-style-type: none"> • Measure the input voltage and ensure it is within the operating limits for the controller. Refer to <i>Technical data</i> on page 7 for voltage tolerance ranges. • Check the controller nameplate and ensure it is connected to the correct power source. • Increase the Deceleration Time (t_d in the ADVANCED Menu) • Verify all check valves are operational. <p>If the alarm persists:</p> <ul style="list-style-type: none"> • Contact customer service |
| R9 | <p>Under Voltage</p> <p>The controller will restart when the input voltage is within the valid range.</p> | <p>This fault can be caused by:</p> <ul style="list-style-type: none"> • The controller detected a low input voltage. <p>If the alarm occurs:</p> <ul style="list-style-type: none"> • Measure the input voltage and ensure it is within the operating limits for the controller. Refer to <i>Technical data</i> on page 7 for voltage tolerance ranges. • Check the controller nameplate and ensure it is connected to the correct power source. <p>If the alarm persists:</p> <ul style="list-style-type: none"> • Contact customer service. |

7 System Setup and Operation

7.1 Parameters to check upon startup

Check the following programming parameters upon startup:

| Display for RB1 and RB3 | Description |
|-------------------------|--|
| R | Enter the rated current value of the motor indicated on the motor nameplate. Entering the incorrect value can result in damage to the motor, pump, or trigger an unanticipated overcurrent alarm. |
| EL | If there is a level switch or pressure switch, enable control at the digital input to protect against dry running. |
| SP | The operating pressure of the pump needs to be set. Default value is 60 PSI. If the value entered is not correct in relation to the needs of the system, it must be increased or decreased accordingly. If more than 1 minute is required to fill the system during initial start-up and the converter triggers the dry running alarm, increase the \overline{P} parameter (MIN.PRESS) as long as the pumps are running. (Make sure that the pumps are primed). Lastly, decrease the \overline{P} parameter (MIN.PRESS) to the minimum permitted pressure. |
| \overline{P} | Set the minimum pressure below which the pump is automatically stopped after the delay time (dL parameter). This function prevents dry running. |



WARNING:

If the system is connected to a municipal supply, check that the sum of the pressure of the supply and the maximum pressure of the pump does not exceed the value of the maximum permitted operating pressure (maximum working pressure MWP) of the pump, tank or of the controller.

7.2 Tank pressure

After setting the required operating pressure of the system, modify the precharge pressure of the diaphragm tanks.

See [Pressure tank installation](#) on page 12 for more information.

7.3 Pre-start checks

Make sure that the following are completed before you start the pump system powered and controlled by the controller:

- Mechanical installation
- Hydraulic installation
- Electrical installation
- Check the pre-charge pressure of the tank
- Program the controller

NOTICE:

Do not run the system dry. Start the pump only after filling it completely with liquid.

7.4 Prime the pump

- Prime the pump using the priming cap on the intake pipe (when applicable) or following the instructions in the manual provided with the pump.

7.4.1 Negative suction head pumps

- Fill the intake pipe by pouring water into the priming hole in the intake pipe of the pump.
- Fill the pump bodies at the caps near the delivery flange. Refer to the pump manual.

7.4.2 Positive suction head pumps



- Open the valve installed on the intake pipe.
- When there is sufficient head, the water overcomes the resistance of the non-return valve installed on the pump's intake line and fills the pump bodies.
- If this does not occur, prime the pump at the caps near the delivery flange. Refer to the pump manual.

NOTICE:

Never run the pumps for more than 5 minutes with the discharge valve closed.

7.5 Start the pump

Refer to [Figure 6: User interface](#) on page 15 for an explanation of the buttons on the user interface.





- The pump is at a standstill and the Start/Stop (9) and Mode LEDs (10) are off when the controller is turned on.
- Press (1)  to enter AUTOMATIC mode.
- The pump starts up and the Start/Stop (9) and Mode LEDs (10) are illuminated if the pressure of the system is below the SET POINT value.
- For RB3 models, check the direction of rotation of the motor.
- After a few seconds, providing the pump is primed correctly, the pressure of the system shown on the display starts to increase and, with all the valves closed, the pump stops.
- If instead the pressure remains steady at 0.0 PSI after a few seconds of operation, with the valves closed, press (2)  and stop the pump. The pump has not been primed correctly and is running dry.
- Reprime the pump and repeat the start-up process.

7.6 Change the direction of rotation

Refer to [Figure 6: User interface](#) on page 15 for an explanation of the buttons on the user interface.

If using a 3 phase output controller and motor, change the direction of rotation of the motor as follows:







1. Enter MANUAL mode, press (2) , and the LEDs (9) and (10) are off.
2. Press (3)  for 3 seconds and access the BASIC menu (MB). The Mode LED (10) flashes.

3. Press (6)  until parameter r5 is displayed.
4. Press (5)  to select rotation direction.
5. Press (6)  to confirm. Exit the menu
6. Enter AUTOMATIC mode, press (1) , and the Mode LED (10) is illuminated and steady.

7.7 Set the operating pressure

Refer to [Figure 6: User interface](#) on page 15 for an explanation of the buttons on the user interface.

The controller system is set at the factory for 60 PSI. Modify the pressure value as follows:

1. Enter MANUAL mode, press (2) , and the Start/Stop (9) and Mode LEDs (10) turn off.
2. Press (3)  for 3 seconds and access the BASIC menu (MB) and the Mode LED (10) flashes.
3. Press (6)  until the Pressure Setpoint 5P parameter is displayed.
4. Press (4)  and (5)  to set the new Pressure Setpoint value.
5. Press (3)  to exit the menu and the Mode LED (10) turns off.
6. Press (1)  to select automatic mode and the Mode LED (10) turns off.
7. The pump will start on based on the system conditions. The Start/Stop the LED (9) will turn on when the pump is running.
8. Make sure that the pressure stabilizes at the required value, as seen on the pressure gauge or on the display of the controller.
9. Make sure the pump stops when all discharge valves are closed.

NOTICE:

Make sure that the new SET POINT pressure value is within the range of the head indicated on the data plate of the pump.

Refer to [Figure 6: User interface](#) on page 15 for additional information.

8 Troubleshooting

Precautions



WARNING:

- Observe accident prevention regulations in force.
- Use suitable equipment and protection.
- Always refer to the local and/or national regulations, legislation, and codes in force regarding the selection of the installation site, plumbing, and power connections.



Electrical Hazard:

Before any service or maintenance, disconnect the system from the power supply and wait at least 2 minutes before starting work on or in the unit.

Turn off and unplug the system before installing the unit or carrying out maintenance.

Introduction

In addition to the alarm troubleshooting guide in [Alarms and troubleshooting](#) on page 25, we also provide a guide for troubleshooting other possible problems.



Electrical Hazard:

- Make sure that all connections are performed by qualified installation technicians and in compliance with the regulations in force.
- Always disconnect and lock out power before servicing to prevent unexpected startup. Failure to do so could result in death or serious injury.
- Wait a minimum of two minutes before opening the controller.

8.1 Faults, causes, and remedies

The pump does not run, the main switch is on and none of the LEDs are illuminated

| Cause | Solution |
|---|--|
| No power supply | Restore the power supply and check that the mains connection is intact. |
| Triggered overload circuit breaker or fuse | Reset the overload circuit breaker or replace the fuse. Check that the breaker or fuse is properly sized for the application. |
| Triggered ground fault protective device or circuit breaker | Reset the differential protection. |
| Main fuse of the controller blown | Replace the controller. |
| In the case of single-phase pumps, the motor capacitor is faulty. | Replace the capacitor if it is an external one. Contact the local sales and service representative if it is an internal capacitor. |
| Triggered ground fault protective device | <ul style="list-style-type: none"> • Reset the differential protection. • Replace the GFCI with an RCCB A or B type. |

All discharge valves are closed and the electric pump runs at intermittent speeds

| Cause | Solution |
|---|---|
| Water leaking out of the non-return valve or out of the system. | Check the system to locate the leaks. Repair or replace the components. |
| Diaphragm tank with broken diaphragm. | Replace the tank. |
| Pressure setpoint is set too high. | Reduce the pressure setting in the controller. |

All discharge valves are open and the pump does not start

| Cause | Solution |
|---|---|
| Pressure setpoint is lower than the incoming pressure. | Increase the pressure setpoint inside the controller. |
| Incoming pressure is higher than the value set by the ΔP (Pressure Drop) parameter. | Increase the ΔP (Pressure Drop) parameter. |

The pump runs but starts and stops frequently

| Cause | Solution |
|---|--|
| Diaphragm tank with broken diaphragm. | Replace the tank. |
| Minimum Frequency (F_L) is set too high. | Reduce the Minimum Frequency (F_L) setting. |
| The pump exceeds the pressure set point at minimum frequency. | Increase the Pressure Setpoint (S_P) or replace the pump with a smaller model. |

The pump always runs at maximum speed

| Cause | Solution |
|---|---|
| There could be a problem with the pressure transmitter. | Verify the system pressure reading by comparing to a gauge. |
| The pressure set point is too high and the pump doesn't achieve the pressure desired. | Change the set point. |
| The pump is not primed. | Control the suction condition of pump. |

The input circuit breaker or fuse of the system is triggered.

| Cause | Solution |
|--|--|
| Short circuit | Check the connecting cables. |
| In the case of a single-phase pump, the motor capacitor is faulty. | Replace the capacitor if it is an external one. Contact the local sales and service representative if it is an internal capacitor. |

9 Product Warranty

Commercial warranty

Warranty. For goods sold to commercial buyers, Seller warrants the goods sold to Buyer hereunder (with the exception of membranes, seals, gaskets, elastomer materials, coatings and other "wear parts" or consumables all of which are not warranted except as otherwise provided in the quotation or sales form) will be (i) be built in accordance with the specifications referred to in the quotation or sales form, if such specifications are expressly made a part of this Agreement, and (ii) free from defects in material and workmanship for a period of twelve (12) months from the date of installation or eighteen (18) months from the date of shipment (which date of shipment shall not be greater than thirty (30) days after receipt of notice that the goods are ready to ship), whichever shall occur first, unless a longer period is specified in the product documentation (the "Warranty").

Except as otherwise required by law, Seller shall, at its option and at no cost to Buyer, either repair or replace any product which fails to conform with the Warranty provided Buyer gives written notice to Seller of any defects in material or workmanship within ten (10) days of the date when any defects or non-conformance are first manifest. Under either repair or replacement option, Seller shall not be obligated to remove or pay for the removal of the defective product or install or pay for the installation of the replaced or repaired product and Buyer shall be responsible for all other costs, including, but not limited to, service costs, shipping fees and expenses. Seller shall have sole discretion as to the method or means of repair or replacement. Buyer's failure to comply with Seller's repair or replacement directions shall terminate Seller's obligations under this Warranty and render the Warranty void. Any parts repaired or replaced under the Warranty are warranted only for the balance of the warranty period on the parts that were repaired or replaced. Seller shall have no warranty obligations to Buyer with respect to any product or parts of a product that have been: (a) repaired by third parties other than Seller or without Seller's written approval; (b) subject to misuse, misapplication, neglect, alteration, accident, or physical damage; (c) used in a manner contrary to Seller's instructions for installation, operation and maintenance; (d) damaged from ordinary wear and tear, corrosion, or chemical attack; (e) damaged due to abnormal conditions, vibration, failure to properly prime, or operation without flow; (f) damaged due to a defective power supply or improper electrical protection; or (g) damaged resulting from the use of accessory equipment not sold or approved by Seller. In any case of products not manufactured by Seller, there is no warranty from Seller; however, Seller will extend to Buyer any warranty received from Seller's supplier of such products.

THE FOREGOING WARRANTY IS EXCLUSIVE AND IN LIEU OF ANY AND ALL OTHER EXPRESS OR IMPLIED WARRANTIES, GUARANTEES, CONDITIONS OR TERMS OF WHATEVER NATURE RELATING TO THE GOODS PROVIDED HEREUNDER, INCLUDING WITHOUT LIMITATION ANY IMPLIED WARRANTIES OF MERCHANTABILITY AND FITNESS FOR A PARTICULAR PURPOSE, WHICH ARE HEREBY EXPRESSLY DISCLAIMED AND EXCLUDED. EXCEPT AS OTHERWISE REQUIRED BY LAW, BUYER'S EXCLUSIVE REMEDY AND SELLER'S AGGREGATE LIABILITY FOR BREACH OF ANY OF THE FOREGOING WARRANTIES ARE LIMITED TO REPAIRING OR REPLACING THE PRODUCT AND SHALL IN ALL CASES BE LIMITED TO THE AMOUNT PAID BY THE BUYER FOR THE DEFECTIVE PRODUCT. IN NO EVENT SHALL SELLER BE LIABLE FOR ANY OTHER FORM OF DAMAGES, WHETHER DIRECT, INDIRECT, LIQUIDATED, INCIDENTAL, CONSEQUENTIAL, PUNITIVE, EXEMPLARY OR SPECIAL DAMAGES, INCLUDING BUT NOT LIMITED TO LOSS OF PROFIT, LOSS OF ANTICIPATED SAVINGS OR REVENUE, LOSS OF INCOME, LOSS OF BUSINESS, LOSS OF PRODUCTION, LOSS OF OPPORTUNITY OR LOSS OF REPUTATION.

Xylem |'zīləm|

- 1) The tissue in plants that brings water upward from the roots;
- 2) a leading global water technology company.

We're a global team unified in a common purpose: creating advanced technology solutions to the world's water challenges. Developing new technologies that will improve the way water is used, conserved, and re-used in the future is central to our work. Our products and services move, treat, analyze, monitor and return water to the environment, in public utility, industrial, residential and commercial building services settings. Xylem also provides a leading portfolio of smart metering, network technologies and advanced analytics solutions for water, electric and gas utilities. In more than 150 countries, we have strong, long-standing relationships with customers who know us for our powerful combination of leading product brands and applications expertise with a strong focus on developing comprehensive, sustainable solutions.

For more information on how Xylem can help you, go to www.xylem.com



Xylem Inc.
2881 East Bayard Street Ext., Suite A
Seneca Falls, NY 13148
USA
Tel: (866) 325-4210
Fax: (888) 322-5877
www.xylem.com/goulds

Visit our Web site for the latest version of this document and more information

The original instruction is in English. All non-English instructions are translations of the original instruction.

© 2022 Xylem Inc

Goulds is a registered trademark of Goulds Pumps, Inc. and is used under license.