

PowerPEX[®]

Installation Manual



Tubing

Fitting Systems

Tools & Accessories

Installation Guidelines

Certifications & Listings

Warranty

Supply

Drainage

Support

Specialties

www.siouxchief.com

TAKE THE FIELD.



Sioux Chief PowerPEX[®]

» Installation Manual

Introduction

This manual covers the specifications and installation guidelines for Sioux Chief's full line of PowerPEX[®] tube and PEX fitting systems. The manual describes all of the various ASTM PEX product standards, and how Sioux Chief's PowerPEX products are installed per those standards.

All product or system installations shall adhere to the procedures and guidelines within. Nothing within is intended to establish a warranty beyond Sioux Chief's expressed warranty. Check with all local codes prior to installation.



TABLE OF CONTENTS

1 Tubing

1.1 Explaining PEX Tube **PG 4**

2 PowerPEX Tubing

2.1 Sioux Chief PowerPEX Tube Types, Availability & System Compliance **PG 5**

2.2 PowerPEX Markings / Print Stream **PG 6**

2.3 PEX Tubing Product Standards & Code Compliance **PG 7-8**

2.4 Material Benefits & Properties **PG 9**

3 Fitting Systems

3.1 ASTM F1807 | F2159 Crimp Installations **PG 13-14**

3.2 ASTM F1960 Expansion Ring Installations **PG 15**

3.3 Special Considerations for Polymer Fittings **PG 16**

4 Tools & Accessories

4.1 PEX Accessories, Tools, Gauging & Tips **PG 17**

4.2 ASTM F1807 | F2159 Crimp Tool Repair & Calibration **PG 18**

4.3 ASTM F1960 Expansion Tools **PG 19**

5 Installation Guidelines

5.1 Hybrid Systems/Combination Install **PG 20-21**

5.2 System Installation Options **PG 22**

5.3 Manifold Plumbing **PG 23-24**

5.4 Tubing Installation Requirements & Limitations **PG 25-30**

5.5 Avoiding Common Problems **PG 31-32**

6 Certifications & Listings

6.0 PowerPEX Certifications **PG 34**

7 Warranty & Terms of Use

7.0 Sioux Chief Warranty **PG 36**

»» What is PowerPEX?

Sioux Chief offers the industry's leading PEX systems. Sioux Chief's PEX offering is the most complete in the plumbing industry. **All fitting and tube solutions carry a 25-year warranty, mixed or matched.** Sioux Chief does not limit its warranty on tube or fittings based on matching system connections like some other PEX tubing suppliers.

PowerPEX gives contractors the ability to choose the right tube or fitting connection for each application, layout or contractor comfort level. We call this Fitting Freedom™.

- 
- PEX tubing is economical and cost-effective. Manufacturing PEX tubing consumes less energy than manufacturing metal tubing. It is lighter weight, which helps to lower transportation costs and is easier to handle for the installer. PEX can be coiled, which reduces overall storage space.
 - PEX is flexible, so it can be installed in ways that reduce the total number of fittings needed, which minimizes the potential for leaks. It can help reduce system noise by eliminating sharp bends and reduces hot water wait times when used in manifold systems.

PEX Tubing

»» General Information

PEX Tubing

PEX is cross-linked polyethylene. Through one of several processes, links between polyethylene molecules are formed to create bridges (thus the term “cross-linked”). This resulting material is more durable under temperature extremes, chemical attack, and better resists creep deformation, making PEX an excellent material for potable water and other applications. The physical properties of PEX tubing make it ideal for use with various mechanical connection systems.

There are three primary methods for producing PEX tubing:

PEX-A | “Engel” or Peroxide Method.

Peroxide is added to the base resin. As the tubing is produced, cross-linking takes place due to pressure and high temperature.

PEX-B | “Silane” Method.

Silane is grafted to the backbone of the polyethylene. The grafted compound is combined with a catalyst through the Sioplas or Monosil methods. Extruded tube is exposed to steam or hot water to complete the cross-linking reaction. The resultant link is three-dimensional in nature whereby the bunch-like bond is not unlike a trellis.

PEX-C | Electron Beam Method.

Very high-energy radiation is used to initiate molecular cross-linking in specialty high-density polyethylene. Tube is extruded (generally as HDPE), routed through an E-Beam facility and rotated under a beam in the accelerator where it is dosed with a specific amount of radiation to release the hydrogen atoms and cause polymer chains to link to the open carbon sites. The resultant link is planar in nature and a carbon to carbon bond.

PEX Tubing Applications

PEX tubing is ideally suited for potable water plumbing applications. It is flexible, making it easy to install and service. It is also able to withstand the high and low temperatures found in plumbing and heating applications and is highly resistant to chemicals found in the plumbing environment.

Common Application Types:

- Water service
- Potable water plumbing
- Hydronic / radiant cooling
- Hydronic / radiant heating*
- Snow / ice melting systems*
- Turf conditioning systems
- Permafrost systems
- Water reclamation
- Fire suppression**
- Mixed (plumbing + fire suppression, etc.)
- No Lead systems
- Geothermal
- Dezincification resistant systems

* Special system component consideration and elimination of ferrous components must be made for radiant or snow melt systems when using non-barrier tubing.

** Check with local codes and applicable requirements.

PowerPEX[®] Tubing

Flexible, Durable, Quality Tubing – Made in America 

Sioux Chief PowerPEX - PEX-A

Sioux Chief PEX-A tube is made using the Engel process described earlier where heated extrusion of a specialty PE resin containing a high concentration of organic peroxide creates PEX. As the peroxide decomposes, bonds on the polyethylene chains are formed.

Sioux Chief PowerPEX - PEX-B

Sioux Chief PEX-B tube is made using the Sioplas method described earlier. This involves a 2 component extrusion with the base material comprising 95% of the end product and the catalyst to start the reaction accounting for the remaining 5%. The reaction begins at extrusion and is accelerated by curing at elevated temperatures and with moisture exposure.

PowerPEX Tubing

TUBE SIZE	STANDARD	DESIGNATION CODE & TUBE TYPE	
Non-Barrier Tube			
1/2"	ASTM F876/F877	5306 (PEX-B)	3006 (PEX-A)
3/4"	ASTM F876/F877	5306 (PEX-B)	3006 (PEX-A)
1"	ASTM F876/F877	5306 (PEX-B)	3006 (PEX-A)
1-1/4"	ASTM F876/F877	5306 (PEX-B)	3006 (PEX-A)
1-1/2"	ASTM F876/F877	5306 (PEX-B)	3006 (PEX-A)
2"	ASTM F876/F877	5306 (PEX-B)	3006 (PEX-A)
Oxygen Barrier Tube			
1/2"	ASTM F876/F877	5006 (PEX-B)	3006 (PEX-A)
3/4"	ASTM F876/F877	5006 (PEX-B)	3006 (PEX-A)
1"	ASTM F876/F877	5006 (PEX-B)	3006 (PEX-A)

PowerPEX Fitting Size Availability

	3/8"	1/2"	3/4"	1"	1-1/4"	1-1/2"	2"
ASTM F1807	■	■	■	■	■		
ASTM F2159		■	■	■			
ASTM F1960		■	■	■	■	■	■
ASTM F3347		■	■	■			
ASSE 1061	■	■	■	■	■	■	■

PowerPEX Tube & Fitting System Compatibility

	PEX-B TUBING	PEX-A TUBING	BARRIER PEX-B	BARRIER PEX-B	PE-RT TUBING
ASTM F1807 Crimp™ PEX	■	■	■	■	■
ASTM F2159 Crimp™ PEX	■	■	■	■	■
ASTM F1960 Grip™ PEX	■	■	■	■	■
ASSE 1061 PDQ™ Push Fit	■	■	■	■	■
ASTM F3347 / F3348 Compression Sleeve PEX	■	■	■	■	■

Sioux Chief PowerPEX Tube Markings

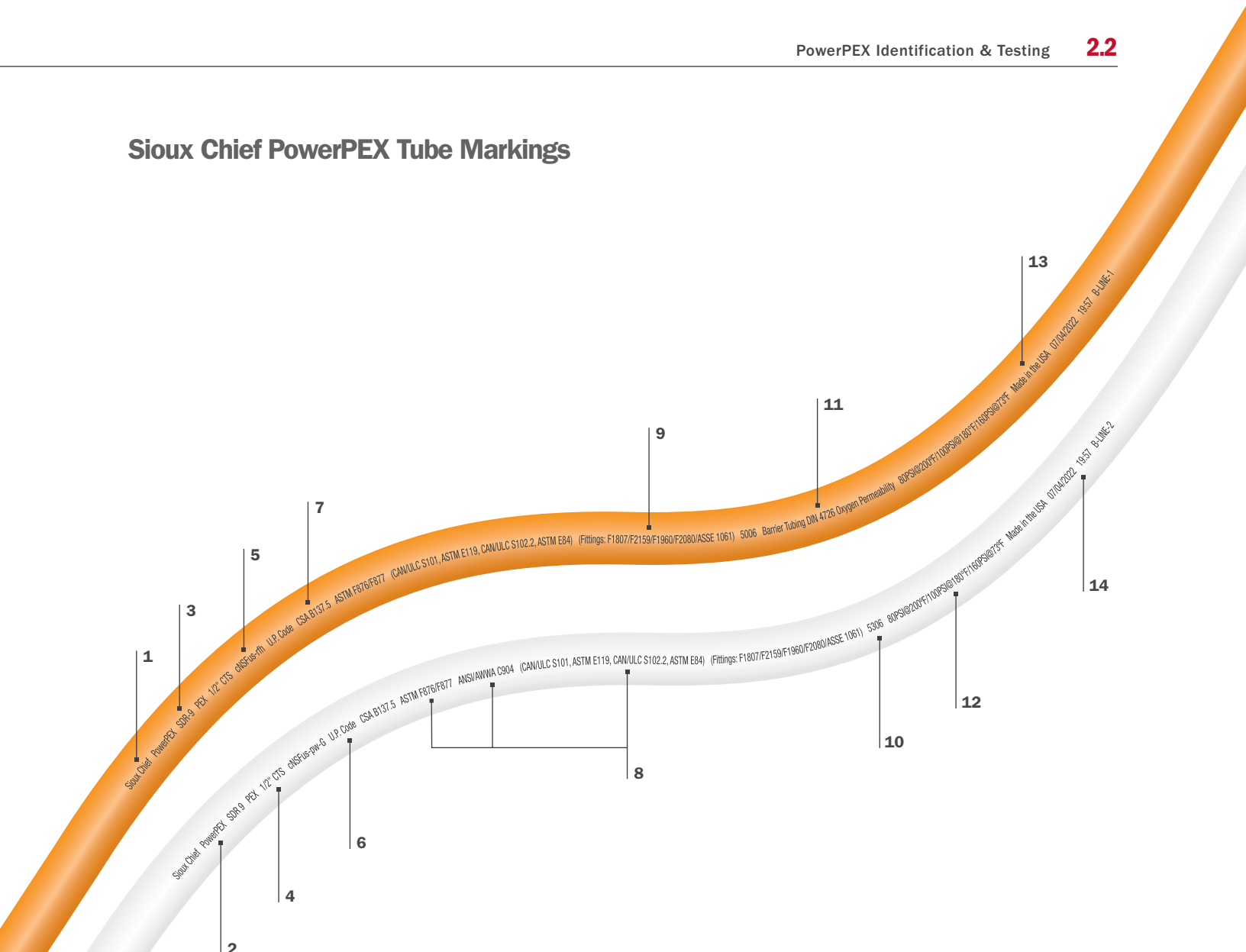

PRINTED MARKINGS ON TUBING	
1	Company Name
2	Product Name
3	Standard Dimensional Ratio For Fitting Size Acceptance
4	Tubing Size
5	National Sanitation Foundation Mark for Toxicity and/or Performance Certification
6	IAPMO Listing (Model Plumbing Code Body)
7	CSA Listing & Canadian Certification
8	Applicable Standard Certifications for Performance & Manufacturers
9	Compatible Fitting Systems Standards
10	Chlorine & UV Resistance Per Standard
11	Oxygen Barrier Specification (if applicable)
12	Pressure & Temperature Rating
13	Country of Origin
14	Date, Time, & Manufacturer's Line Tracking Number

PEX Tube Designation Code Example: 5306

Integer 1: (chlorine resistance) PER

ASTM F2023

- 0 = Not tested for Chlorine resistance
- 1 = 25% use @ 140°F
& 75% use @ 73°F
- 3 = 50% use @ 140°F
& 50% use @ 73°F
- 5 = 100% use @ 140°F

Integer 2: (min. UV resistance) PER

ASTM F2657

- 0 = Not tested for UV exposure
- 1 = Max. exposure of 1 month
- 2 = Max. exposure of 3 months
- 3 = Max. exposure of 6 months

Integer 3&4:

(HDS @ 73°F) × 100 psi.

- 06 = 630 psi.

PEX Tube: Chlorine Resistance and UV Inhibition

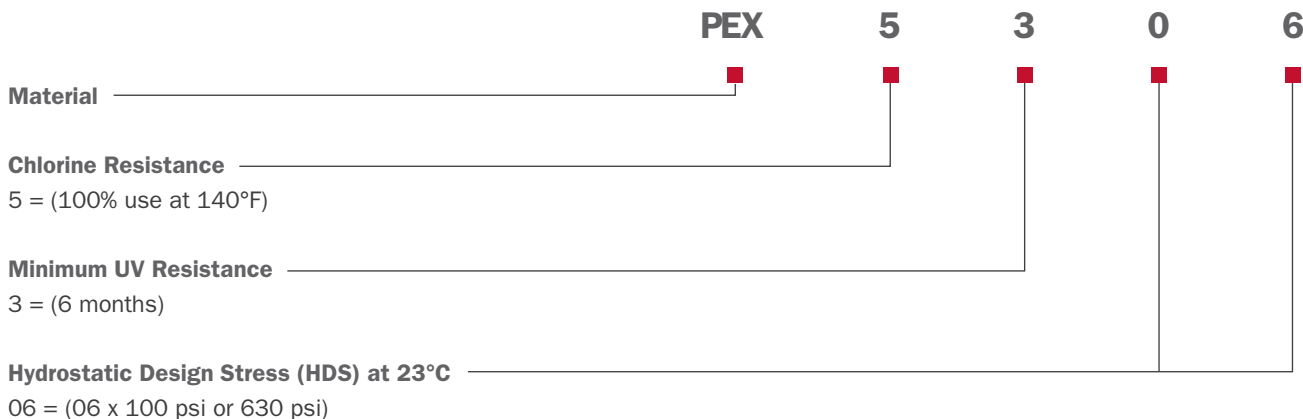

Sioux Chief PowerPEX Production Tests and Continuous Compliance Tests

TEST	STANDARD	FREQUENCY
Density	ASTM D1505	Each Tubing Run
Hydrostatic Sustained Pressure	ASTM D1598	Random Continuous Samples
Hydrostatic Burst Pressure	ASTM D1599	Each Tubing Run
Environmental Stress Cracking	ASTM F876	Annually
UV Inhibition	ASTM F2657	During Certification
Degree of Cross-linking	ASTM D2765	Each Tubing Run
Stabilizer Functionality	ASTM D1598	During Certification
Oxidative Stability	ASTM F2023	During Certification
Bent Tube Sustained Pressure	ASTM D1598	Annually
Excessive Temp + Pressure Capability	ASTM D1598	Each Random Continuous Samples
Melt Flow Index	ASTM D1238	Each Receipt
Ongoing Dimensional Checks (OD, ID, Wall Thickness, Homogeneity, Etc.)	ASTM F876/877	Continuous
Ongoing Dimensional Checks - Fittings (Copper, Brass, Plastic)	ASTM FITTING STANDARD	Each Run
Rockwell Tests for Copper Crimp Rings	ASTM F1807	Each Run
Alloy Material Test (X-Ray Florescence Analyzer)	ASTM FITTING STANDARD	Each Receipt
Certificate of Resin Compliance	PER MSDS SHEET	Each Receipt
Crush Test (for PPSU Fittings)	ASTM F2159	Random Continuous Samples

Tubing Product Standards

ASTM F876: Standard Specification for Cross-linked Polyethylene (PEX) Tubing

ASTM F877: Standard Specification for Cross-linked Polyethylene (PEX) Hot & Cold-Water Distribution Systems

CSA B137.5: Cross-linked Polyethylene (PEX) Tubing Systems for Pressure Applications

ASTM F2623: Standard Specification for Polyethylene of Raised Temperature (PE-RT) SDR9 Tubing

ASTM F2769: Standard Specification for Polyethylene of Raised Temperature (PE-RT) Plastic Hot and Cold Water Tubing and Distribution Systems

ASTM E84 & CAN/ULC S102: Standard Test Method for Surface Burning Characteristics of Building Materials

ASTM E119 & CAN/ULC S101: Standard Test Methods for Fire Tests of Building Construction and Materials

ANSI/AWWA C904: Cross-Linked Polyethylene (PEX) Pressure Tubing, ½ In. (13 mm) Through 3 In. (76 mm), for Water Service

Code Acceptance

Tubing Code Compliance Below is a list of commonly referenced and recognized plumbing model codes, which recognize PEX tubing installation and reference standards for application and installation compliance. Individual standards can be referenced in section 6.

Area / Region Many cities, states, counties or other jurisdictions may employ and determine what standards, specifications, and plumbing/heating practices are satisfactory. Check with all local and state codes prior to any installation.



Sioux Chief utilizes the most state-of-the-art extrusion equipment and facilities to manufacture, inspect, stock, ship and service PEX tubing to the plumbing and radiant heating industries.

Material Benefits of PEX Tubing

Corrosion Resistant

Smooth inner walls inhibit mineral build up and scaling. Resists pitting or stress-corrosion more than other types of tube. PEX is also more resistant to the harmful effects of chemicals such as chlorine.

Quiet

Flow characteristics are increased and system noise is decreased when compared to metal tubing systems.

Freeze Resistant

While it is always recommended to follow code requirements and common practices to protect from freezing, PEX tubing can expand and contract more easily (often without damage) than copper and CPVC tubing.

Reduced Turbulence / Increased Flow

The smooth interior wall of the tube reduces turbulence during water demand thereby increasing the overall flow characteristics to the fixture being supplied.

Thermal Conductivity

Lower heat transfer compared to metal tube, saving energy and money.

Installation Flexibility

PEX tube bends easily and can be plumbed around building members or through floors/walls. Using flexible tubing means fewer fittings, fewer brackets, fewer joints behind the wall, fewer hours on the job, and fewer potential leaks.



CORROSION
RESISTANT



QUIET



FREEZE
RESISTANT



FLEXIBLE

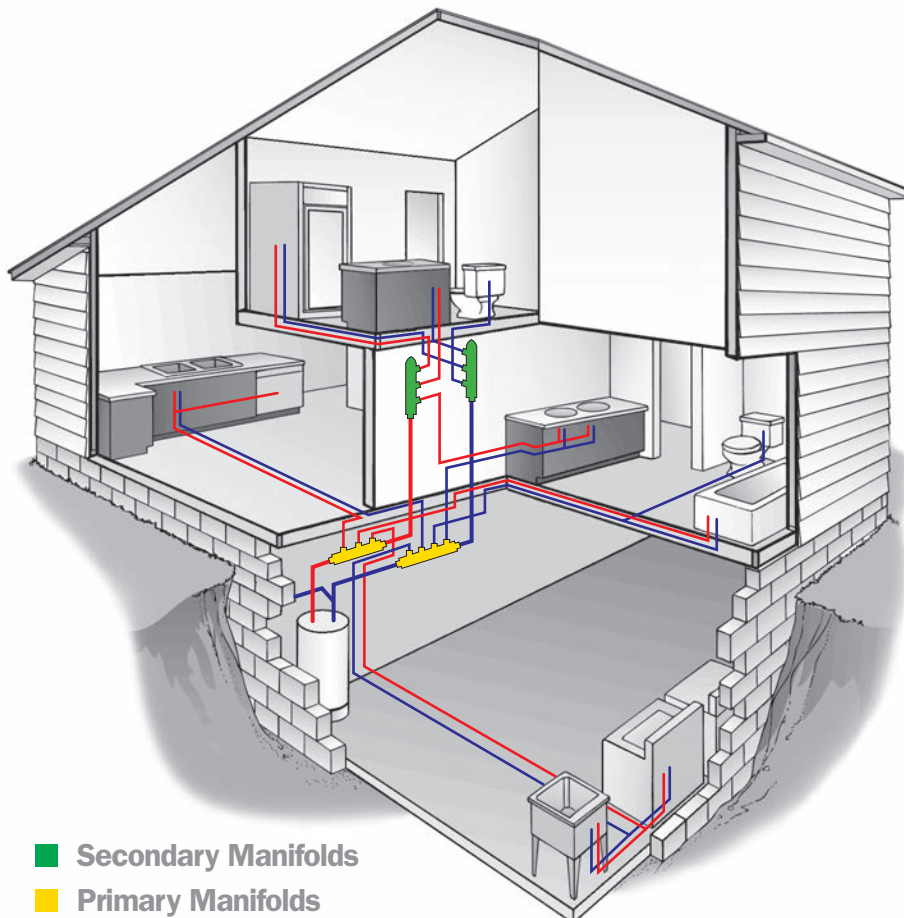

■ Secondary Manifolds

■ Primary Manifolds

Installation Tips

- When servicing a line, Sioux Chief recommends using valved manifolds whenever possible. Primary manifolds should always be valved.
- Manifolds can always be coupled together with other manifolds and PEX tube to achieve the desired number of branches.

⚠ IMPORTANT

Do NOT recirculate back through the manifold branch. Doing so will void the manifold warranty.

Material Properties of PEX Tubing

Water Temperature + Water Pressure

PEX tubing shall not be used in applications where temperature and pressure ratings are not regulated or are known to evidence exposures beyond the tested and certified limit of the tube.

Tube Operating Pressure / Temperatures

TEMPERATURE	HYDROSTATIC PSI (MAX)	OPERATING PSI WATER
73.4° F / 23° C	630	160
180° F / 82.2° C	400	100
200° F / 93.3° C	315	80

Thermal Expansion & Contraction

PEX has a thermal expansion rate of 1.10" per 10°F ΔT per 100 ft. (27.94mm per 5.56°C ΔT per 30.48m).

Bending Stress on Polymer Fittings

Polymer fitting joints should be properly supported to avoid undue stress on fittings and connections. A minimum distance of 2x the tubing O.D. should be allowed before changing the direction of the tube. Sioux Chief recommends *always* using a manufactured bend support.

Support + Spacing

TUBE SIZE	HORIZONTAL SUPPORT SPACING	VERTICAL SUPPORT SPACING
1/2"	32"	Once per floor penetration at floor level. Once at midpoint of floor expanse or every 48"
3/4"	32"	
1"	32"	
1-1/4"	32"*	
1-1/2"	32"*	
2"	32"*	

*See Section 5.4 for Tubing Installation Requirements & Limitations. Or, specific manufacturer's instructions for continuous pipe support systems for large diameter horizontal arterial water mains.

Minimum Bend Radius*

TUBE SIZE (CTS)	MIN. BEND RADIUS
1/2"	3.75"
3/4"	5.25"
1"	6.75"
1-1/4"	8.25"
1-1/2"	9.75"
2"	12.75"

*Without bend support. See Section 5.4 for additional information.

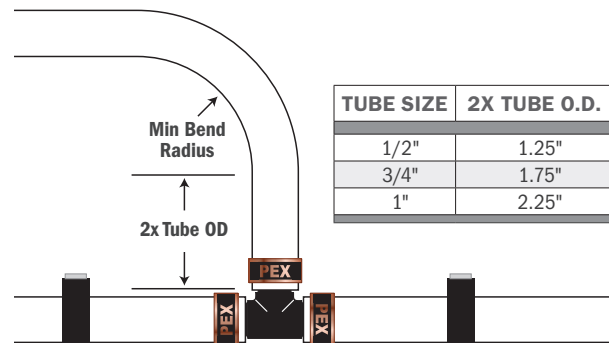

Flow Characteristics

GPM	1/2" PRESSURE DROP @ 60°F (PSI/100FT)	VELOCITY (FT/SEC)	3/4" PRESSURE DROP @ 60°F (PSI/) 100FT	VELOCITY (FT/SEC)	1" PRESSURE DROP @ 60°F (PSI/100FT)	VELOCITY (FT/SEC)
1	1.8	1.7	1.2	0.9	.4	0.5
2	5.9	3.5	2.4	1.8	.7	1.0
3	12.1	5.2	4.0	2.7	1.2	1.6
4	20.1	7	5.7	3.5	1.8	2.1
5			8.1	4.4	2.5	2.7
6			10.7	5.3	3.2	3.2
7			13.5	6.2	4.1	3.7
8				7.1	5.0	4.3
9					6.0	4.8

Fitting Systems

» Making the Connection

PEX tubing can be used with a variety of fitting systems, each defined by their respective ASTM Standards:

ASTM F1807 | F2159 Crimp™



Standard Specification for Metal¹ or Plastic² Insert Fittings Utilizing a Copper Crimp Ring, or Alternate Stainless Steel Clamps, for SDR9 Cross-linked Polyethylene (PEX) Tubing and SDR9 Polyethylene of Raised Temperature (PE-RT) Tubing

1 = ASTM F1807 2 = ASTM F2159

ASTM F1960 Grip™



Standard Specification for Cold Expansion Fittings with PEX Reinforcing Rings for Use with Cross-linked Polyethylene (PEX) and Polyethylene of Raised Temperature (PE-RT) Tubing

ASTM F3347 | ASTM F3348



Standard Specification for Metal¹ or Plastic² Press Insert Fittings with Factory Assembled Stainless Steel Press Sleeve for SDR9 Cross-linked Polyethylene (PEX) Tubing and SDR9 Polyethylene of Raised Temperature (PE-RT) Tubing

1 = ASTM F3347 2 = ASTM F3348

ASSE 1061



Performance Requirements For Push-Fit Fittings

PowerPEX = The Power to Choose

The ability to choose the right tube or fitting connection for each application, layout or contractor comfort level. We call this Fitting Freedom™. Sioux Chief understands smart plumbing systems may incorporate “hybrid” PEX offerings to maximize each connection system's benefit. The Power to Choose puts the plumber back at the heart of smart plumbing.





PowerPEX[®] ASTM F1807 | F2159

▶▶ Copper Crimp Ring Installation



1. Cut tube at 90-degrees. Do not crush OD of tubing with cutters. Hint: Slightly rotate cutter during blade engagement.



2. Install PEX Crimp Ring onto OD of tubing. Install PEX fitting fully into tube end.

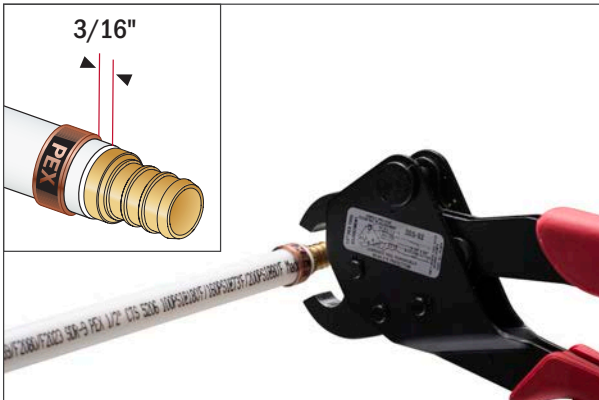

3. Position ring over sealing barbs of the fitting. The ring should be positioned 3/16" ($\pm 1/16$ ") from the end of the tube.



4. Compress tool perpendicular to tube. Compress only once. Remove defective connections. Use a gauge to assure a proper joint. Test all completed joints.

Installation Notes: Take care to avoid the below issues when making joints with copper crimp rings

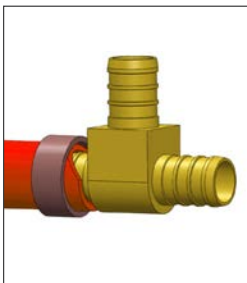

Tube not cut squarely - ring not compressing tube for a secure seal.

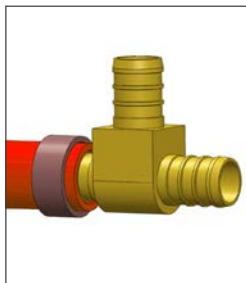

Fitting not inserted completely into tube end.

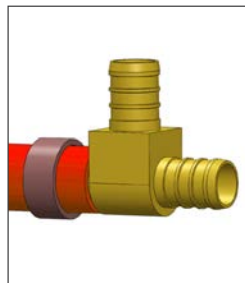

Ring placed too far forward or too far back & not positioned over sealing barbs of fitting.

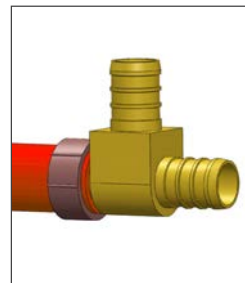

Improperly calibrated tool - not enough compression. Rings compressed multiple times may develop a leak path.

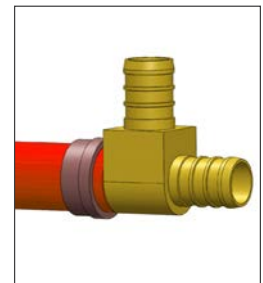

Crimp Tool did not engage the Crimp Ring over the entire surface of the ring.

V-Sleeve™ Compression Sleeve Installation



1. Cut tube at 90-degrees. Install V-Sleeve onto OD of tube with notched side towards tube end. Install fitting fully into tube. Visually confirm tube is fully inserted through notches.



2. Compress tool perpendicular to tube - Compress only once. Remove any defective connections. Use a gauge to assure a proper joint. Test all completed joints.

Note:

Be sure to use a properly calibrated compression tool designed SPECIFICALLY to make V-Sleeve or F3347 metal press sleeve connections.



Always check sleeves before use. Creased or bent sleeves should never be installed.

Stainless Steel Cinch Clamp Installation

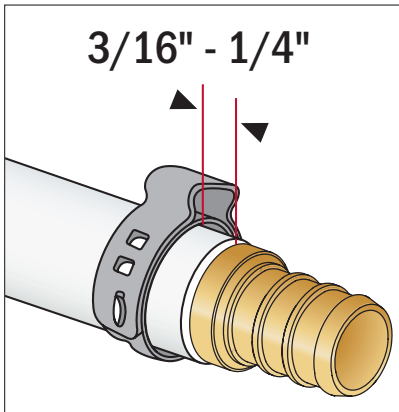

1. Cut tube at 90-degrees. Load clamp over tube end. Insert fitting fully into tubing. Position clamp between 3/16" and 1/4" from tube end to ensure coverage of both sealing barsbs.

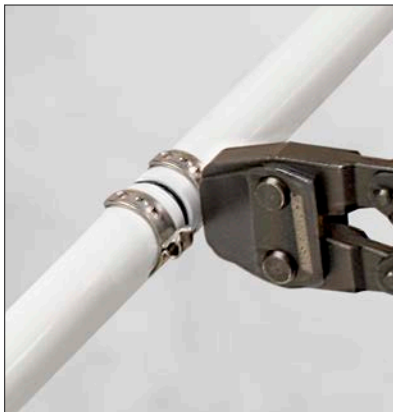

2. Close clamp ear with ratchet pincer tool. Tool will not release until clamp is fully closed. Remove any defective connections. Test all completed joints.

Note:

Full ear closure is required for proper installation. Always visually inspect clamp for correct closed-ear form.

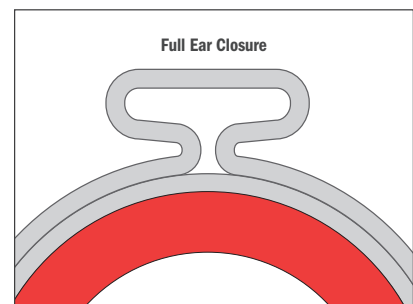

Check ratchet pincer tool calibration with a GO/NO-GO gauge daily. Refer to tool manufacturer's instructions for calibration procedures.



Installation Notes:

In high-chloride water conditions, use only plastic (ASTM F2159) fittings. Do Not install in contact with concrete. Avoid contact with soldering flux.

PowerPEX® ASTM F1960

Expansion Ring Installation



1. Cut tube at 90-degrees. Do not crush OD of tubing with cutters. Hint: Slightly rotate cutter during blade engagement.



2. Install an approved PEX expansion sleeve onto OD of tubing.



3. Using expander tool, expand sleeve fully. If using a manual tool, expand **slowly** and repeat expansions, **rotating expander** 1/8-turn between expansions. Forcing the tube onto the expansion head and/or expanding too quickly can damage the tubing and sleeve, and require rework.



4. Insert fitting into expanded tube and sleeve. Hold fitting in place until tube/sleeve constricts annularly around the fitting.



5. The installation is complete with a visibly secure connection. Remove defective connections. Test all completed joints.

Note: Sioux Chief recommends all ASTM F1960 expansion joints using PowerPEX Type-B tubing be made with a self-rotating, power expansion tool to avoid improper expansion.



Special Considerations for Making Large-Diameter, or Low-Temperature F1960 PEX Expansion Joints:

When expanding large diameter tubing or in temperatures below 55°F, Do Not force the tubing onto the expansion head. Expand slowly and evenly at the prescribed rate of expansion. When using a manual tool, always rotate the tool. Keep tube/sleeves warm (Tip: store sleeves in pockets) to ensure uniform expansion and decrease the time needed to fully constrict around fitting. In colder temperatures, fewer expansions are needed. Use only enough tool expansions/rotations to allow full insertion of the fitting. Both lower temperatures and over-expansion of the tube/sleeve will increase the time needed to fully constrict and complete the joint. Do Not make connections in temperatures below 5°F. Do Not apply heat with a heat gun - Excessive heat may damage tube/sleeves/fittings.

Installation Problems: Take care to avoid the below issues when making joints with PEX expansion rings



Be sure tubing is cut squarely, tube is inserted into sleeve completely and fitting is inserted fully into tube/sleeve.

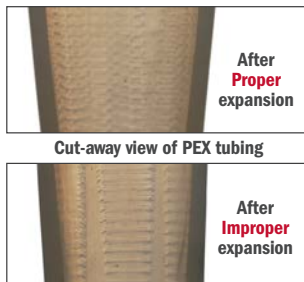

No rotation between expansions, or defective expansion head leaving a groove as a potential leak path.



Damaged, cut or grooved barb on fitting.

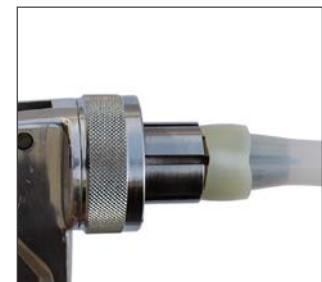

Failure to rotate tool inside tubing may cause unequal expansion. Remove any rings with unequal expansion.

Polymer Fittings

»» Special Considerations for Use

Chemical Resistance:

Some chemicals can cause damage and should not come in contact with polymer fittings. These chemicals include



(but are not limited to): Adhesives, petroleum based substances, paints, solvents, oxidizing agents, disinfectants, PVC primers/solvents/cements, leak detection liquids, oil/lubricants, pipe

dopes, ethylene glycol, or other volatile compounds. It is the responsibility of the installing contractor to verify compatibility of any chemicals that come into contact with the PPSU fittings.



Polymer fittings that have been damaged by chemicals MUST be removed from service.

Spray-Foam Compatibility

Some spray-foam insulation products are approved for use with PEX tube and fittings. It is the responsibility of the installing contractor to refer to information provided by the insulation manufacturer and verify compatibility of any foam or chemical foaming agents that will come into contact with PowerPEX tube and fittings, including polymer PowerPEX fittings. If insulation manufacturer recommends wrapping PEX tube joints before application, see Section 5.5 for Requirements for Wrapping a PowerPEX joint.

Heat / Flame:

Do not subject polymer fittings to open flame. Do not solder within 18" of polymer fittings. Flame or heating sources beyond material tolerances must be avoided.



U.V. / Sunlight:

Polymer fittings should be protected from UV exposure.



UV radiation can significantly decrease ductility, strength, and impact resistance. Fittings that have been exposed to harmful UV radiation should be removed from use.

Temperature / Radiant Heating:

The maximum short-term working temperature (30 days) of fittings: 210 °F (99 °C) @ 150 PSI. Constant Working Temperature: 140 °F (60 °C) @ 55 PSI. PPSU fittings are suitable for radiant heating and cooling applications under the following conditions:

1. Use only propylene glycol - Max: 60% by volume
2. DO NOT USE ETHYLENE GLYCOL WITH PPSU FITTINGS
3. Maximum temp: 194°F (90°C) at 44 PSI
4. Recommended Corrosion Inhibitors: Metal Guard™
H50 (6% by volume), H60 (4% by volume), H80 (4% by volume)

Mechanical Stress:

Fittings should be kept free of mechanical stress. Do not subject polymer fittings to excessive impact. Do not subject fittings to torque exceeding 100 lbs. of force. Each joint should be properly supported. To avoid undue stress on polymer fittings and connections, a minimum distance of 2x the tubing O.D. should be allowed before changing the direction of the tube. Sioux Chief recommends *always* using a manufactured bend support.

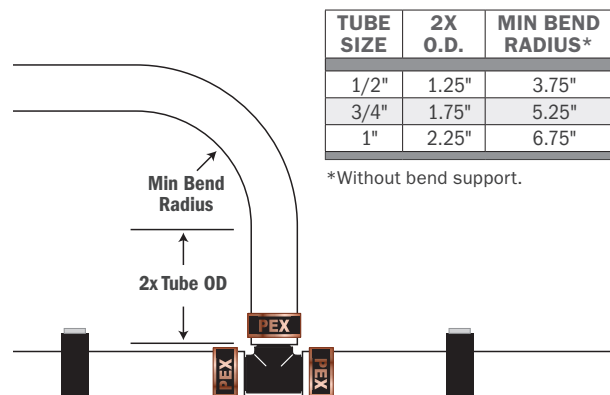

Tools & Accessories

Usage Guidelines

PEX Accessories

PEX Tube Cutter

USE: Hold cutter perpendicular to tubing. When cutter is set at a right angle to tube length, squeeze handle and cut tube flush. Slightly rotate tube cutter when blade engages tubing OD to prevent "ovaling" the tube.

REPAIR: Remove screw and replace cutting blade with replacement blade. Reassemble and replace the screw.



Compression Insert (Tube Stiffener)



Stainless Steel or PPSU PEX inserts must be used when a supply fixture valve will be pushed or compressed onto PEX tube. ASSE 1061 push-fit fittings for use on plastic tubing must use an insert sized appropriately to the tube type ID.

Crimp Ring Removal Tool

USE: Cut the tube close to the fitting. Place ring removal tool into the fitting end and make two cuts approximately 3/8" apart. Remove ring sections with pliers. Twist off tube. **Inspect** fitting for reuse. Be sure barbs are undamaged and fitting has not been compromised.

NOTE: Not for use with PPSU or other polymer fittings



Go/No-Go Gauges

Gauges are available for both crimp and compression sleeve systems. All Sioux Chief PowerPEX tools include Go/No-Go gauges

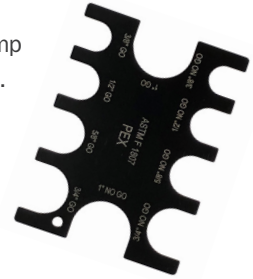

Coil Unwinder

USE: The unwinder remains in place on three stable legs with adjustable feet while the coil swivels freely, making it easy for users to pull tubing as needed.



Push Fit Disconnect Tools

USE: Load the properly-sized tool over the tube and against the push fitting. Squeeze/push the tool against the fitting socket to engage the release mechanism. Pull tube/fitting apart using a twisting motion.



ASTM F1807/F2159 Crimp & Compression Tools

All tools include an instruction sheet. **READ THE INSTRUCTION SHEET CAREFULLY AND UNDERSTAND IT.**

Crimp/Compression Tool Calibration

Check tool calibration regularly. It is recommended that at least the first and last crimp of the day/project is tested.

All tools include a Go/No-Go gauge - use the gauge to determine if the tool needs calibration:

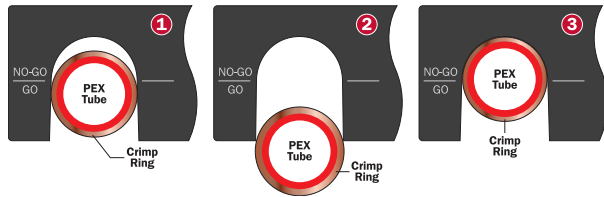

Note: Do Not gauge where jaw marks show on ring

1. If the crimped ring slides into the slot and stops in the 'GO' area of the gauge, the crimp is **GOOD**
 - No calibration is needed.
2. If the crimped ring is too large to pass into the slot of the gauge, the crimp is **NO GOOD**
 - Adjust tool by increasing number on calibration dial.
3. If the crimped ring slides into the 'NO GO' area of the gauge, the crimp is **NO GOOD**
 - Adjust tool by decreasing number on calibration dial.

To Calibrate Standard Tools

- Open jaws and loosen LH or RH nuts on back of tool.
- Turn LH or RH calibration dial one increment at a time.
- Retighten nuts on back of tool.
- Perform a crimp and check with gauge.

To Calibrate Compact Tools

- Remove C-clip on back of tool with screwdriver.
- Push/rotate calibration dial one increment at a time.
- Replace C-clip with pliers.
- Perform a crimp and check with gauge.

Note:

- If you are not able to obtain good crimps after calibration, the tool is likely worn and should be replaced.
- Lubricate linkages regularly to maximize tool life.
- Do not remove Date Code sticker. Removal voids tool warranty.
- Always place tools in a durable case or secure box to protect the tool head from damage.

Standard Crimp Tools

ITEM NO.	DESCRIPTION
305-7023	1/2" & 3/4" Crimp tool with straight handle
305-7040	1" Crimp tool with straight handle
305-7050	1-1/4" Crimp tool with straight handle
305-7095	Crimp tool kit for 3/8", 1/2", 5/8", 3/4", 1"

Compact Crimp Tools

ITEM NO.	DESCRIPTION
305-7110	3/8" Compact crimp tool with case
305-7120	1/2" Compact crimp tool with case
305-7123	1/2" & 3/4" Compact crimp tool with case
305-7130	3/4" Compact crimp tool with case

Standard Sleeve Compression Tools

ITEM NO.	DESCRIPTION
305-82TX	Old style - 1/2" sleeve compression tool
305-84TX	Old style - 1" sleeve compression tool
305-802	1/2" SS sleeve compression tool
305-803	3/4" SS sleeve compression tool
305-804	1" SS sleeve compression tool

Compact Sleeve Compression Tools

ITEM NO.	DESCRIPTION
305-92TX	1/2"



ASTM F1960 Expansion Tools

All tools include an instruction sheet. **READ THE INSTRUCTION SHEET CAREFULLY.**

Expansion Tool Verification and Use

1. Attach appropriately sized expansion head to an ASTM F1960 expansion tool.
2. Ensure assembly is wholly intact and the male threads of the tool or female threads of the jaw set are not compromised.
3. Ensure the retention spring on the OD of the tool jaw is in place and not compromised. If a jaw section is missing or damaged, replace the expansion jaw.
4. Keep the expansion jaw and the tool driver properly lubricated.
5. Place tool jaw into tube end/ring assembly and compress handles to expand for fitting install.

Note: For any battery issues with F1960 power tools under warranty, call Sioux Chief customer service.

NEVER Use a damaged or misaligned expansion head.

NEVER Use mismatched tools and expansion heads or tools and heads from different manufacturers.



Damaged Head

Worn springs can lead to misaligned jaws and improper expansion of tube.

Fitting Spacing

When installing F1960 fittings, it is important to keep the minimum distance between expansions shown in the table below:

PIPE SIZE	MINIMUM DISTANCE BETWEEN EXPANSIONS
3/8"	2.00"
1/2"	2.50"
3/4"	3.50"
1"	4.50"
1-1/4"	5.50"
1-1/2"	6.50"
2"	7.50"

F1960 Expansion Tools

ITEM NO.	DESCRIPTION
305-W23KIT	Expansion tool kit for 1/2" & 3/4" F1960
305-WT	Expansion tool for F1960
305-W2H	1/2" F1960 expansion head
305-W3H	3/4" F1960 expansion head
305-W4H	1" F1960 expansion head

Using PEX-B with ASTM F1960 Systems

PowerPEX Type-B tubing is approved for use with ASTM F1960 fittings and expansion joints. If using a manual tool, expand *slowly* and repeat expansions, *rotating expander* 1/8-turn between expansions.

SIoux CHIEF STRONGLY RECOMMENDS ALL ASTM F1960 EXPANSION JOINTS WITH POWERPEX® TYPE-B TUBING BE MADE WITH A SELF-ROTATING, POWER EXPANSION TOOL.

Self-rotating, power expansion tools are designed to automatically expand the tubing at the proper rate, while rotating a set distance per activation. These features assure the connection achieves the necessary tube ID and overall connection geometry which allow the tube and fittings to be used together. When making ASTM F1960 connections, proper tool installation protocols must be maintained per the manufacturer's installation and operating instructions.



Expand Evenly

When expanding PEX tubing, especially large diameter tubing or in low temperatures (below 55°F), Do Not force the tubing onto the expansion head in an attempt to reduce the number of expansions.

Take care to expand *slowly and evenly* at the prescribed rate of expansion. When using a manual tool, expand slowly and rotate the tool.



General Installation Guidelines

Layouts, Manifold Systems, and Common Problems to Avoid

Hybrid/Combination System Installations

Hybrid Systems

WHAT: Hybrid systems combine multiple plumbing connection types within one system. Example: A branch run may be plumbed in F1807 PEX whereas an arterial water main may be plumbed in copper or CPVC.

HOW: PowerPEX offers quality tube and quality fittings. Each is independently warranted regardless of system installation as long as they are in a compliant tube & fitting mix.

WHEN: Hybrid applications work perfectly (as depicted on pgs 21-22) in applications where a header is plumbed in a more thermally stable tubing offering while branching off to a more flexible and cost-effective connection system solution.

WHY: A plumber or building owner should not be restricted from choosing the strongest connection system that an application may require, or a connection system they are not comfortable with, or that does not allow them to compete.

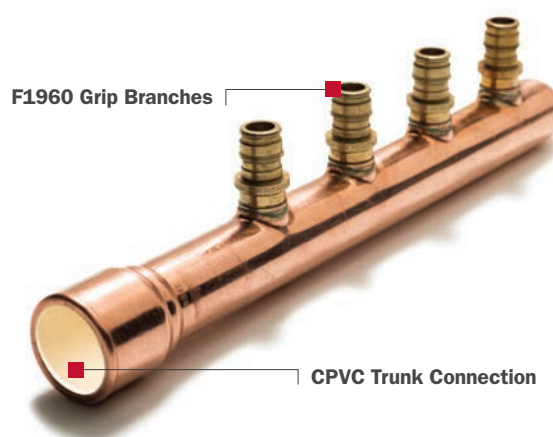

PowerPEX = The Power to Choose

The ability to choose the right tube or fitting connection for each application, layout or contractor comfort level. We call this Fitting Freedom™. Sioux Chief understands smart plumbing systems may incorporate “hybrid” PEX offerings to maximize each connection system's benefit. The Power to Choose puts the plumber back at the heart of smart plumbing.



Hybrid/Combination System Installations

Continued

Combination Systems

Combine the best features of a home run plumbing system with the best features of a trunk and branch plumbing system.

The Smarter Choice:

- Saves materials, especially in No Lead compliant systems.
- Requires half the installation time of traditional systems.
- Requires fewer connections, which translates to fewer leak possibilities, fewer callbacks and fewer claims.
- Exhibits increased flow characteristics, decreased hot water wait times and a decrease in system noise.

Combination: 16 fittings
Trunk & Branch: 96 fittings

Combination: 59 connections
Trunk & Branch: 165 connections

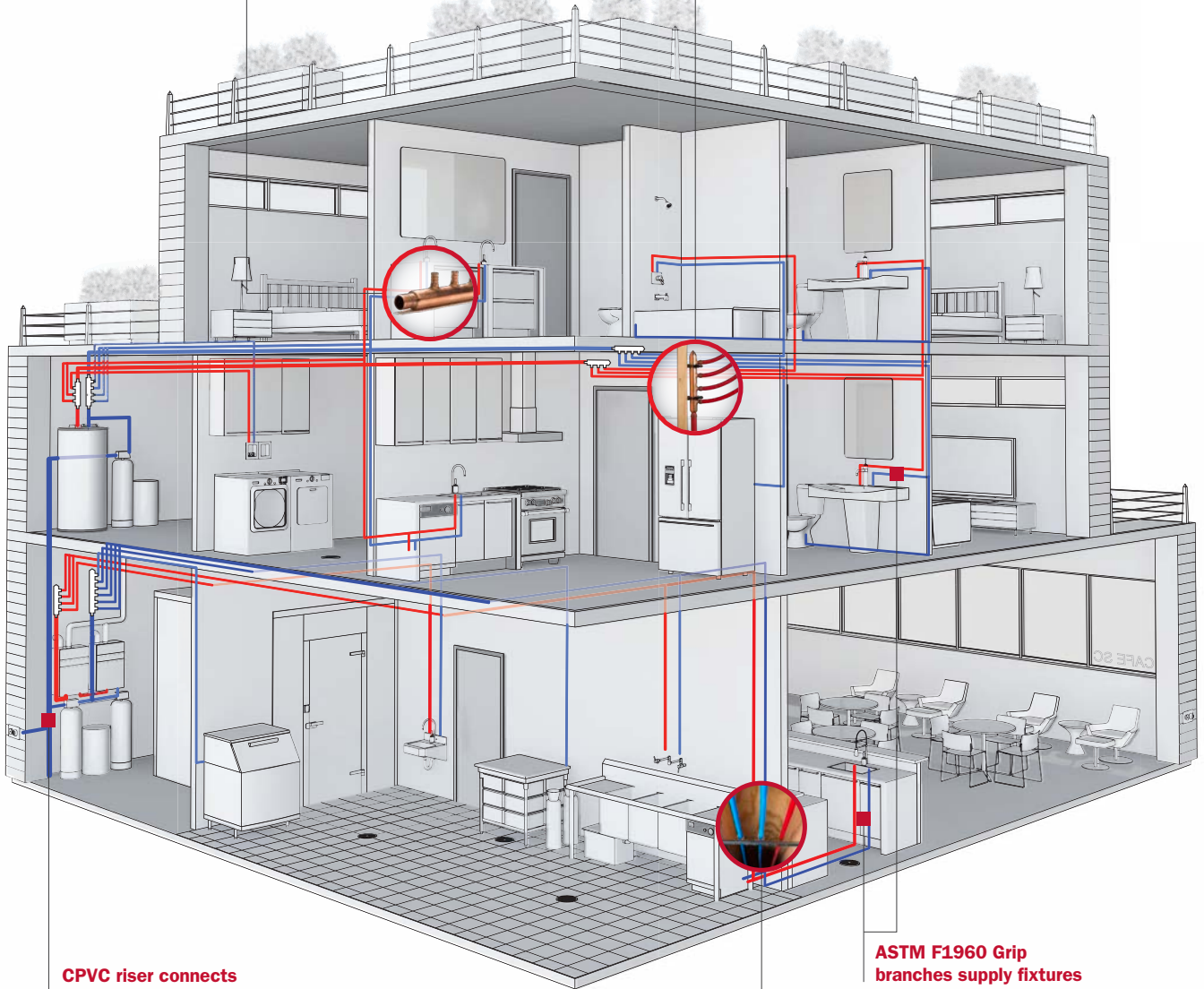

CPVC riser connects directly to manifold

ASTM F1960 Grip branches supply fixtures

Combination: 637ft of tube
Home Run: 1,515ft of tube

System Installation Options

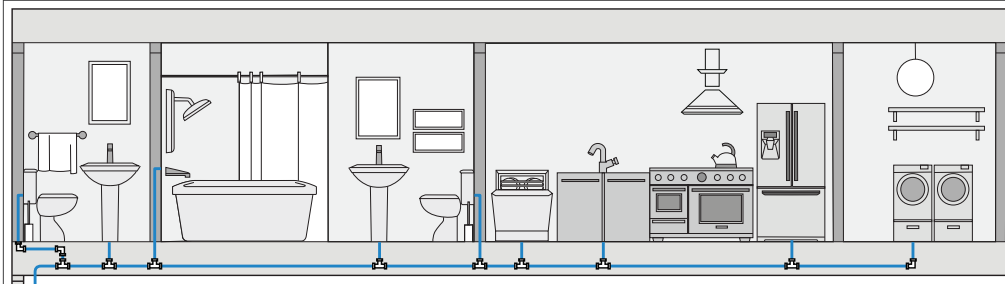

Standard Trunk & Branch

A network of supply tube and fittings service fixtures and are put together like conventional copper or CPVC systems. For every change in direction within the system, an elbow or tee is used (directionals). There is typically more volume of water within a system of this nature and stagnant water must be purged before hot water is realized.

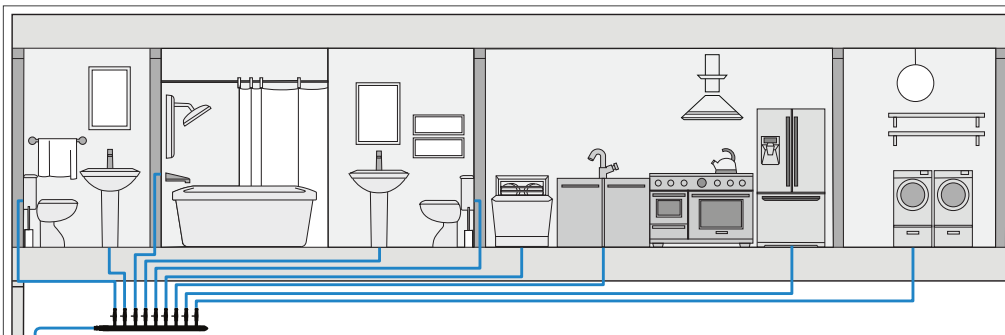

Home Run

Fixtures are supplied from a central manifold. These manifolds are often referred to as primary manifolds, and when used in this manner, can isolate a fixture for repair or service, and ensure proper flow at the fixture by providing an individual supply line. Primary manifolds for home run plumbing typically incorporate valves for proper line segregation and service.

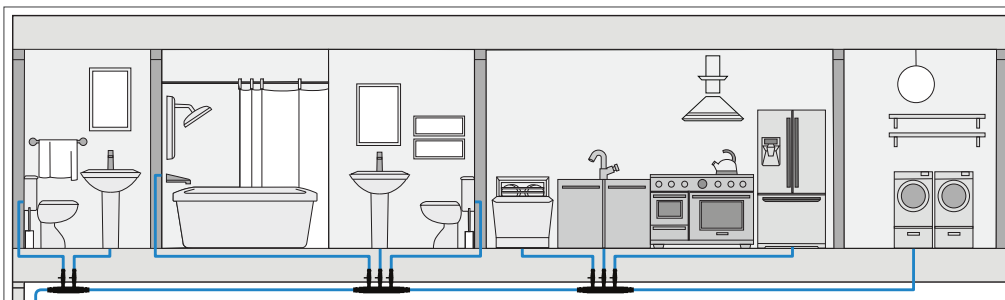

Hybrid/Combination

Fixtures are supplied from a manifold with a line being directly plumbed from a primary manifold or a secondary manifold. Secondary manifolds are either valved or non-valved and can be installed in-line. Valved manifolds typically require access, so non-valved manifolds are more often used as secondary manifolds and can be hidden in walls. The manifold can be marked with the fixture it supplies and a layout schematic marks the manifold location as well as the fixture it provides.

Sioux Chief recommends this plumbing system approach.

Manifold Plumbing

Sizing

Using manifolds can be accomplished with one of the previously mentioned plumbing layouts. Typically, the size of the manifold is dependent on the amount of fixtures it will be supplying. Sioux Chief offers manifolds with different trunk sizes and in varying outlet connections and sizes. All outside hydrants and/or auxiliary fixtures fed from their own supply line would total the branch quantity needed. Some manifold applications purposefully oversize the manifold by 2 branches for possible future additions. These 'extra branches' are typically sealed off with a plug. If two fixtures within a bathroom or kitchen application can legally be supplied with a single supply line, the manifold would reflect one less branch.

Location / Accessibility

Typical home run applications should dictate that a manifold is located near the water conditioning equipment, utility room, or water heater. This area is chosen so that the heated water is fed as quickly as possible to the distribution point for efficient transfer of conditioned water. In any case, the location chosen should be readily accessible for service situations. Manifolds should not be located closer than 3" from a water heater hot line outlet.

The home run layout has half of the connections at the manifold itself with the other half located at the stub out and/or supply stop.

Combination systems allow the cold water distribution manifold (no valve) to be located in a convenient area within the structure (no access panels are required for manifolds without valves).

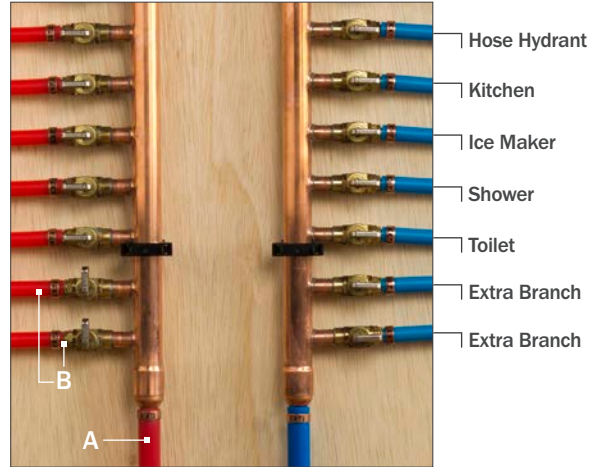

Note

For hot water distribution, branches (B) that are closer to the incoming hot line (A) will have faster hot water supply rates to fixtures downstream.



IMPORTANT



Do NOT recirculate back through the manifold branch. Doing so will void the manifold warranty.

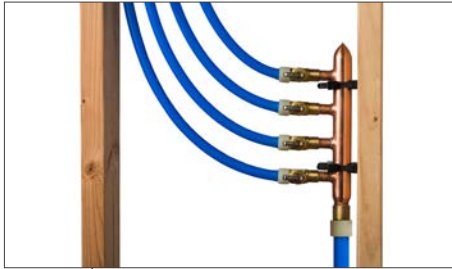

Manifolds with Valve
Often located in service rooms or behind access panels

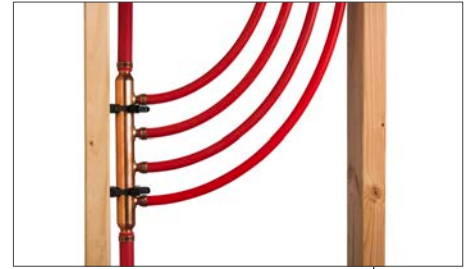

Manifolds, Flow-Through
Often in-line without valves

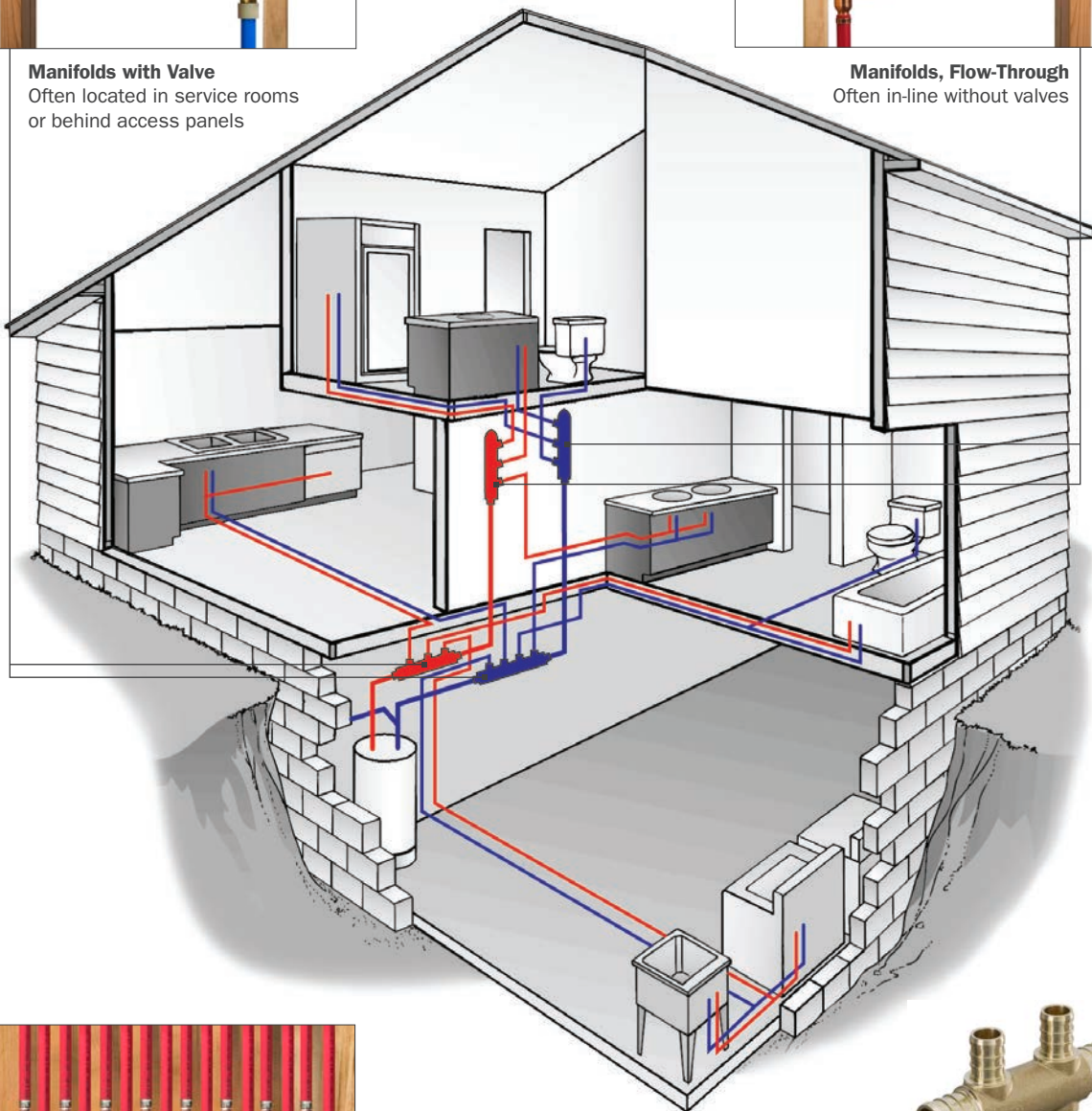

Radiant Manifolds
Allow for fine-tuning of supplied water volume to radiators or tubing loops (not shown in illustration)



Multiport Tees
Compact, 'H' pattern design, can be used for smaller projects or to isolate individual rooms or groups of fixtures.

Tubing Installation Requirements & Limitations*

Tube Protection

Protect tube with properly regulated and certified stud guards and metal plating where tube protrudes through building members. See tubing insulation requirements below.

When undue stress will be placed on a connection joint, use an appropriate fitting with strapping means (drop ear elbow, eared stub out) and make connection to secured fitting.

Example: Shower arm installations. Hydrant installations

Tube Support

Reference mandated support length intervals through local code regulations. Typically horizontal spacing shall be every 32" and vertical spacing shall be 48" and at each floor penetration.

Tube supports should be used to support a long tubing length/run in addition to regular tube support intervals.

Supports should be used to secure any expansion loop or tubing offset.

PEX bend supports can be used when minimum bend radius requirements cannot be met and to prevent tube from kinking when installed per installation instructions.

Tube Insulators

Tube insulators must be used when a tube protrudes through wood or metal studs. Generally, insulating tube is a practice used to protect the tube from:

1. Potential harm (as in damage from metal stud edges)
2. Thermal Dissipation: Do not bundle hot and cold tubing together.
3. Noise Transmission: PEX has a lower modulus of elasticity whereby noise/acoustic transmission is less likely. Insulators further guard against this phenomenon.

PEX Design Factor

The Design Factor (DF) for PEX tubing per AWWA C904 is 0.50. Pressure ratings are based on a typical Hydrostatic Design Basis (HDB) for PEX of 1,250 psi and the Design Factor of 0.50 resulting in the Hydrostatic Design Stress (HDS) of 630 psi

This is the "06" in the PEX Material Designation Code

Thermal Expansion & Contraction.

PEX has a thermal expansion rate of 1.10" per 10°F ΔT per 100 ft. (27.94mm per 5.56°C ΔT per 30.48m).

Slab Installation

Do Not make any fitting joints under the slab. Use a tube sleeve material when penetrating a slab or concrete floor.

Note: Sioux Chief recommends a rigid tube support/sleeve when penetrating a concrete slab for protection during construction and placement of tubing.



Spray-Foam Compatibility

Some spray-foam insulation products are approved for use with PEX tube and fittings. It is the responsibility of the installing contractor to refer to information provided by the insulation manufacturer and verify compatibility of any foam or chemical foaming agents that will come into contact with PowerPEX tube and fittings, including PPSU or other polymer material. If insulation manufacturer recommends wrapping PEX tube joints before application, use linerless black rubber tape.

(See Section 5.5, Requirements for Wrapping a PowerPEX Joint)

In general, ICYNENE closed-cell, polyurethane spray foams are compatible with Sioux Chief PowerPEX tubing. Information provided on MD-R-210, LD-C-50, and MC-C-200 has been reviewed and found that there should be no compatibility issues with PowerPEX tubing.

During application of spray-applied polyurethane foam insulation, all installation instructions provided by the manufacturer must be followed. During the curing process, conditions should not exceed the temperature and pressure limitations of the tube.

Fire-Suppression Materials

It is the responsibility of the installing contractor to refer to information provided by the fire-protection material manufacturer and verify compatibility of any fire-protection material that will come into contact with PowerPEX tube and fittings, including PPSU or other polymer material.



* For more information on tubing installation requirements and limitations, refer to the current edition of the *PE Pipe Handbook*, published (online) by the Plastics Pipe Institute.

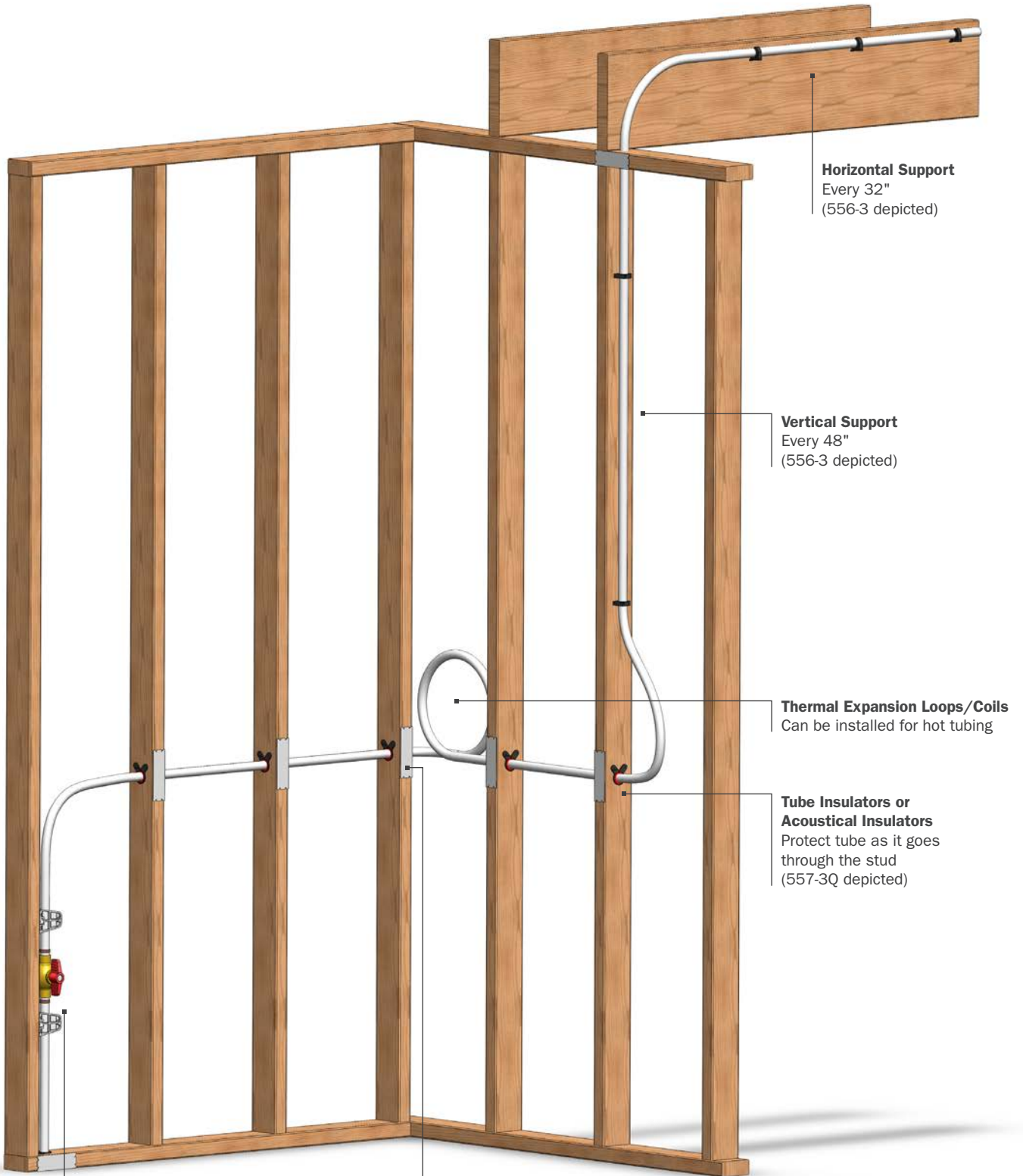

Horizontal Support
Every 32"
(556-3 depicted)

Vertical Support
Every 48"
(556-3 depicted)

Thermal Expansion Loops/Coils
Can be installed for hot tubing

Tube Insulators or Acoustical Insulators
Protect tube as it goes through the stud
(557-3Q depicted)

Joint/Valve Support
Proper support enables a rigid installation
(525-33C depicted)

Stud Guard or Metal Plates
Protect tube from possible nail penetration
(530-3 depicted)

Tubing Installation Requirements & Limitations

Continued

Inspection & Pressure Test

Ensure all tube is free of defects and harm.

Inspect all connections to assure they are leak-free and properly supported. Proper tube anchors and fasteners must be used. Test the system as code dictates. Where the code is absent, test to 100 psi for no less than 12 hours before covering any connection or tubing underground or behind walls. If testing with water, protect from freezing. If more than 10% pressure is lost during hydrostatic or air tests, add more and test for another 12 hours.

Sleeving Service Main

Where PowerPEX tubing enters foundation walls, rigid tubing shall be used to protect tube from shearing due to ground settlement or other earth movement. The rigid sleeve shall protrude into the earth minimally 12" and pass through to the interior of the building. Backer rod (closed-cell foam rod or mineral wool) can be used to seal the gap around the tube and capped with water based caulking as filler.

Where PowerPEX tubing enters concrete floors, follow referenced slab penetration sleeve recommendations

Expansion Joint Protection (Concrete)

When PowerPEX tubing is being run below an eventual radiant-type expansion joint, tubing shall be protected from the possibility of being cut using a metal sleeve material and/or by assuring that the tubing is suitably set below the eventual cut.

Repairs in Service Work

If damage occurs to tubing while in the service stage, it is recommended that the area be replaced (if at all possible) without the use of a fitting below grade. When a fitting must be installed below grade, use a fitting made from C69300 brass for maximum dezincification resistance and stress corrosion cracking resistance. Sleeve and insulate the entire connection for protection from possible corrosion and from any mechanical stress that may occur. Test the assembly. Assure proper slack has been left in the line and proper backfill compaction has been obtained to limit movement on the connection.

Water System Disinfection

AWWA C651-14 shall be referenced when disinfecting PowerPEX tube installations and/or practices outlined by local codes.

- Do not allow solutions to remain in tubing for more than 24 hours
- Upon disinfection completion, flush all systems with potable water.
- Cover tube ends whenever not in use, preventing debris from entering tube.
- Only use disinfecting agents appropriate for PEX water service as well as possible use of PPSU PEX fittings.

Pressure Testing Water Mains

Water service tubing should have pressure applied throughout the installation. Air should be bled off the line prior to pressurizing fully hydrostatically. Sioux Chief recommends continuous pressure throughout the installation process to evidence any leaks or damage that may cause tube/connection failure. Testing water pressures should be set higher than the expected service pressure within the system. Do not test beyond 225 PSI for extended periods of time. 150 PSI water testing pressure is recommended for service mains throughout the construction phase.

Pressure Testing Water Tubing

Water: (recommended). When using water to test distribution tubing, it is important to follow local codes. It is important not to exceed the pressure limit of the tubing. Reference the continuous use pressures and hydrostatic pressure limitations in section 2.4.

Air: When using air to test pipe, there may be a need to condition the pipe especially when testing in hotter weather. PEX-B tubing does not need to be conditioned to the extent that PEX-A tubing should due to physical characteristics of the two tubing types.

Conditioning:

Conditioning the pipe is a process used to slightly expand the tubing ID beyond what the test will effectively expand it to in an effort to maintain the desired test pressure without a 'false negative' of decreased pressure due to normal tubing expansion. Expanding the tube by using 40 psi beyond the testing pressure would

Tubing Installation Requirements & Limitations

Continued

be recommended. Sioux Chief would suggest testing with air up to 80 psi.

Procedure:

- 1) Fill system with air or water.
- 2) Remove all plumbing fixtures or appurtenances that may harm a pressure test and/or should not be exposed to excessive pressures.
- 3) Increase pressure over desired testing pressure for a period of about 30 minutes while maintaining the higher PSI. EG: 100 PSI if testing pressure will be 60 PSI.
- 4) After the 30-min conditioning time, relieve pressure down to 60 PSI. The PSI may climb slightly above 60 as the pipe shrinks due to relieved pressure. After witnessing the final pressure (which may take about five minutes depending on ambient temperature and may increase to around 63-65 PSI), determine if the system is air tight over the necessary code mandated testing time.

Water Service Installation & Limitations

Getting Started. Local codes should be referenced for acceptable pressures as well as special precautions on use of PEX, system fittings, layout and installation requirements for service piping. Typical water service pressure requirements often mandate that the service is capable of withstanding 1.5x the operating pressure of the system it is supplying. See listed PEX pressure ratings. Ensure the fittings and tubing being installed are acceptable for potential pressures, stresses, and application requirements.

Preparation. Check all tubing and fittings for proper listings. Check all tubing and fittings for structural and manufacturing integrity as well as issues that may have arisen from transport or initial installation. Remove any fitting or tube section that has been subjected to cuts, gouges or other excessive installation hazards. Make sure proper analysis of soil and soil chemistry has been completed. Make sure trench is prepared according to guidelines.

Soil Analysis. Do not install PEX tube or fittings in areas where known chemical spills have occurred or where a likely chemical spill can occur. Do not install PowerPEX tubing in soils contaminated with solvents, fuels, organic solvents, pesticides or other harmful materials for

plastic tubing or its fitting systems. Local plumbing code authorities and Sioux Chief should be contacted if there is a question on the installation or area of installation.

Note 1: Do not allow backfill weight to cause tube to become out-of-round beyond 5%. Do not over compact backfill.

Note 2: Sioux Chief recommends using a sleeve material for the entire length of the buried service main.

Trench Layout Guidelines. If the soil has been graded and deemed acceptable, the next step is to gauge the type of soil so that proper installation can proceed. Installations shall be made in an acceptable soil condition or prepared soil condition that supports the tube against future settlement. ASTM D2774 and Chapter 7 of PE Pipe Handbook (see bottom of page 25) shall be additionally referenced for plastic tube used for service work.

Installation In Different Soil Types

Good Soils. Tube may be directly installed on the trench bottom. Code should be referenced for embedment practices and necessary spacing requirements of the tube in the ground. Tube should be laid into trench with slack. Trench bottom is to be clear of any pits or humps as well as sharp objects. Test tube. Compact initial backfill to prevent settlement. Test after backfill.

Rocky Soils + Solid Rock. Tube shall have an additional 6" of trench dug below desired level of service tubing. Prepared trench bottom shall have a 6" layer of pea gravel or other non-sharp substrate trench base installed (pea gravel suggested). Prevent humps or pits where tubing will be laid. Test tube. Compact initial backfill to prevent settlement. Backfill with 6" of the substrate used for the base. Test after backfill.

Unstable Soils. Tube shall have an additional 4" of trench dug below the desired level of the service tubing. Prepared trench bottom shall have a 4" layer of pea gravel or other non-sharp substrate trench base installed (pea gravel suggested). Prevent humps or pits where tubing will be laid. Test tube. Compact initial backfill to prevent settlement. Backfill with 6" of the substrate used for the base.

Tubing Installation Requirements & Limitations

Continued

External Temperature

Soldering. Soldering shall be performed minimally 18" from installed PowerPEX tubing unless a heat-trapping device is employed. Make all sweat connections and allow cooling prior to making PEX connections to PowerPEX tubing.

Duct Work - Heating. Tubing shall be insulated from direct contact with heat transmission ductwork that has a possibility to exceed the maximum tubing working temperature of **150°F**. Tubing shall be kept 6" from gas appliance vents except those vents with a thermal protection approved for installation near plastic (PEX) tubing as explicitly called out by the manufacturer. In horizontal tube installations, keep tube 6" away from heat source.

Water Heater Connections. Connections to tubing shall be made minimally 18" from the water heater hot and cold connections on water heaters. Connections to tubing shall be made with metal transition fittings. See Sioux Chief Water Heater Connections section. (www.siouxchief.com)

Heat Lamp + Lighting. Tubing shall be kept minimally 12" from heat source and proper protection shall be used to avoid overheating tubing. Keep tube protected and 12" from recessed lighting when installed in vertical alignment to heat source. If 12" distance is not available, proper insulation should be used to protect tubing where insulation maintains the necessary heating certifications for the application. PEX must be protected from any UV light-producing device.

Frozen Tubing. PEX tubing should not intentionally be frozen. The frozen section of tubing and the general area should be protected from further exposure to unadvisable installations. Heat the affected area or the blockage assuring that tubing does not overheat. Use a hand to test surface. Space heaters, warm towels, or warm water submersion are acceptable means to thaw tube.

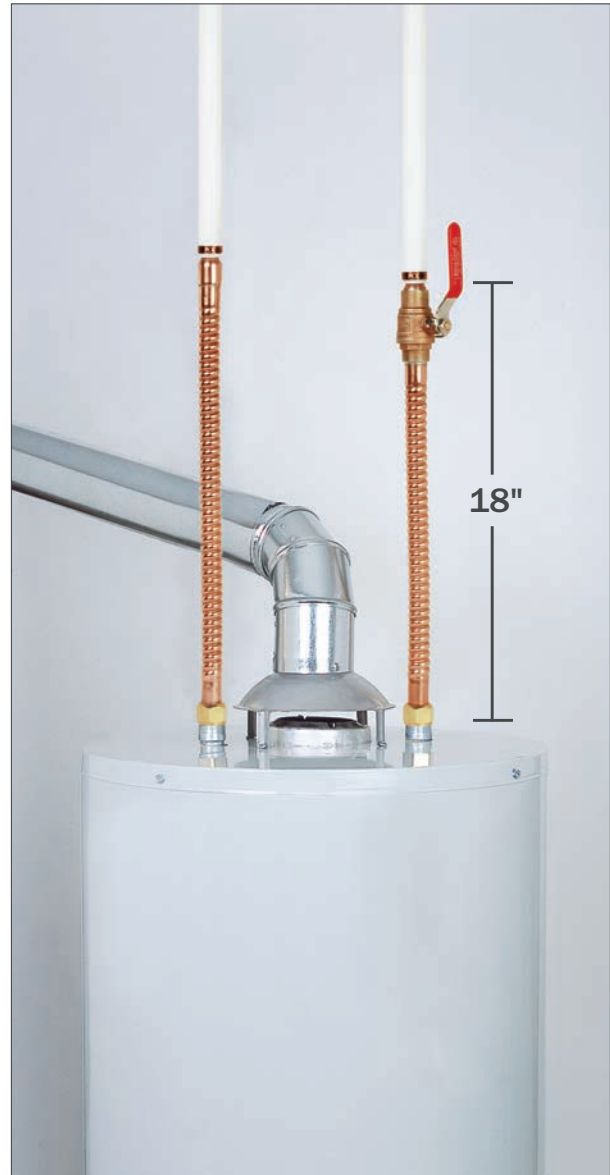

Welding. Do not attempt to weld or fuse tubing.

Kinked Tube. Remove Kinked sections or sections of pipe that have exceeded maximum out-of-roundness.

Tubing Installation Requirements & Limitations

Continued

Vermin Protection

Protect tube from exposure to rodents or other nuisances that may damage the tubing.

Water Hammer Exposure

Water Hammer is generally defined as the damaging pressure surge and banging noise caused by the quick stoppage of the water column when a valve or faucet is turned off abruptly. PEX tubing, like all other materials, needs to be protected from water hammer by the installation of certified water hammer arresters. If left uncontrolled, the water hammer pressure surge can exceed the pressure ratings for the tube, causing damage to the system and/or system components. Both the UPC and IPC model codes require the installation of ASSE 1010 water hammer arresters, regardless of tubing material. (See Sioux Chief's website for a full line of water hammer arresters for any application.)

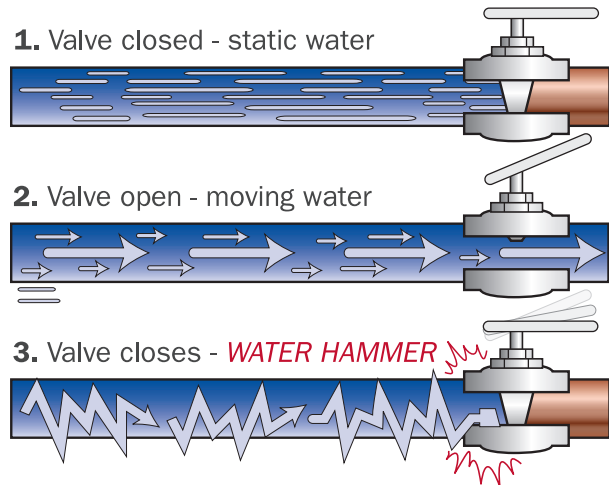

Bend Radius

If coiled tubing is being used and the bend direction is against the coil direction, multiply noted bend radius by a factor of 3. Warmer tubing bends more easily. Generally a bend radius of 8x tube diameter should be sufficient. To avoid undue stress on polymer fittings and connections, a minimum distance of 2x the tubing O.D. should be allowed before changing the direction of the tube. Sioux Chief recommends ALWAYS using a manufactured bend support to ensure the proper bend radius.

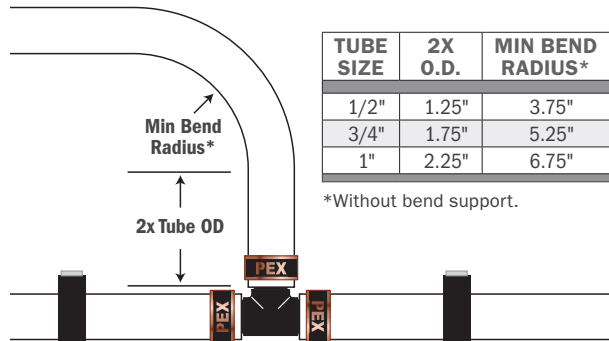

TUBE	MINIMUM BEND RADIUS	BETTER BEND RADIUS	COUNTER-COIL-SET BEND RADIUS
1/2"	3.75"	5"	11.25"
3/4"	5.25"	7"	15.75"
1"	6.75"	9"	20.25"

Thermal Expansion

Linear expansion of PowerPEX tubing is approximately 1.10" per 10°F ΔT per 100 ft.

Do not install tube supports or hangers too tightly. Allow for expansion of tube when bracketing and supporting PEX by allowing 1/8" slack for every 1 foot of linear installation.

For large tubing runs, a tube loop can be installed to allow for proper expansion and contraction.

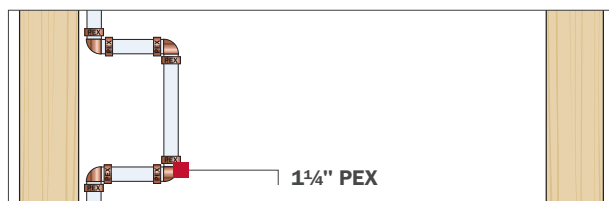
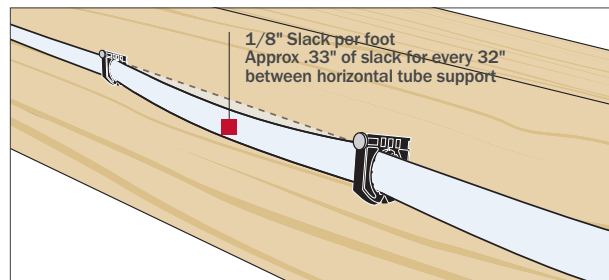

Avoiding Common Problems

Mechanical

PowerPEX tubing should not be scratched, gouged or cut along tube length. Handle with care.



Metal tubing hangers with sharp edges and corners should be avoided. Metal, vinyl-coated tubing hangers specifically designed for uses with PEX tube are acceptable. A better option would be to use an approved plastic hanger from Sioux Chief's extensive line of CTS hanging options.

Note: Acceptable Metal hangers may include PEX bend supports and straight-thru floor sleeves. Plastic PEX bend supports should be used when size and offering permit.

Tube hangers that can easily pinch the tube should not be used. Limit the 'ovaling' of the tube a hanger may cause. Tubing must not be crushed or bent beyond the materials min. bend radius and/or beyond 5% out-of-round by tubing hangers.

Chemical

PowerPEX tubing is a durable, safe and chemical-resistant material that has exceeded the requirements of potable drinking water systems with the highest chlorine testing certifications possible. Tubing that exhibits damage caused by contact with the following should not be used: grease, tar, adhesive tapes, thinners, fuels, sealants, tube cements, fluxes, bleaches, other oxidizing agents and/or petroleum products.



- Do Not allow adhesives to continuously contact tubing. Remove any residue left by temporary or unintentional exposing tube and fittings.
- Do Not use solvent-based paints or petroleum products on or in PowerPEX tubing.
- For compatibility of fire-protection materials that may contact PowerPEX tubing, refer to fire-protection material manufacturer's instructions and recommendations.
- Do Not allow contact with acids or strong bases.
- Keep pesticides, fungicides, and other organic chemicals away from tube.
- Do Not attempt to glue or fuse to PowerPEX tubing.

Electrical

Tube and tube/fitting system shall not be used as an electric ground.

Gas Use

Only use PowerPEX tube in a manner consistent with the tubing identification marking and certifications. Only use PowerPEX in applications presented within this manual and accepted through local and jurisdictional codes. Contact Sioux Chief with questions.

Ultraviolet (UV) Exposure

Do not store PEX tubing unprotected outdoors. Keep PEX tubing in the original packaging or under protective cover until time of installation. Ensure that exposure to sunlight during installation does not exceed the maximum recommended UV exposure time for the tube being installed. See Section 2.2 for a tube's identification marking.



Leak Testing Solutions

All leak-testing agents must be approved for PEX tubing. Some chemicals found in leak-detecting formulations can cause premature PEX tubing failure by developing micro-fracturing of the tube wall.

Polymer (PPSU/PSU) Fitting Limitations

Special considerations should be made when using polymer fittings in PEX systems. See section 3.3.

Brass Fitting Limitations

Sioux Chief's PowerPEX fittings, valves and connectors/adapters are made from multiple materials. These fittings should be installed where allowed by code for hot/cold plumbing applications. For aggressive water jurisdictions prone to dezincification or for areas requiring no-lead fittings, Sioux Chief carries a line of dezincification resistant brass and copper fittings.

Do not allow PEX fitting barbs and fitting ends to be deformed or damaged. A fitting that exhibits a damaged sealing barb or sealing surface should be removed from service.

Avoiding Common Problems

Continued

Copper Fitting Limitations

Sioux Chief's capability as a world leading engineered copper-fitting provider allows Sioux Chief the option of offering naturally no-lead and dezincification-resistant copper fittings for F1807 PEX applications.

Copper fittings are:

- Economical
- Accepted
- Listed
- Historically proven

Do Not install copper fittings in areas prone to copper deterioration. Do Not allow PEX fitting barbs and fitting ends to be deformed or damaged. A fitting that exhibits a damaged sealing barb or sealing surface should be removed from service.

Stainless Steel Fitting Limitations

Sioux Chief sells some PEX fittings in stainless steel alloys or as an assembly with stainless steel alloys. Be sure these fittings are used as potable water fittings for the referenced applications within this manual. Stainless steel products should generally be protected from caustic environments that are known to degrade stainless materials including, but not limited to, high chlorine or bromine environments and/or other environments that produce halogens.

Buried or Concealed Joints

Sioux Chief permits PowerPEX joints (polymer, brass, and copper) to be buried or concealed. Sioux Chief recommends threaded connections never be buried or concealed as they must be accessible for periodic inspection, per building codes.

The requirement to wrap a PowerPEX joint can depend on many factors including location and the presence of other materials that contact or can come in contact with the joint.

Concealed in Inaccessible Locations:

When PowerPEX joints are concealed but are still in open air space (e.g. behind drywall), it is not necessary to wrap the joint. However, the installer should ensure the fittings do not come in contact with chemicals (e.g. PVC glues,

solvents, cements) that could damage the fitting material. If it is determined that the joint should be protected, see below requirements for wrapping a PowerPEX joint.

Buried in a Concrete Slab or in

The Sub-Base Underneath the Slab:

Sioux Chief does NOT recommend burying PowerPEX joints in concrete slabs. If joints must be buried in a concrete slab, or in the sub-base beneath the slab, they must be wrapped (see requirements below). In addition, the location of the joint should be marked and indicated on building drawings.

Buried in soil:

When burying PowerPEX joints in soil, outside of a structure, the joint must be wrapped (see requirements below).

Requirements for Wrapping a PowerPEX joint

- Use linerless black rubber tape.
- Ensure a minimum of 50% overlap of the tape.
- Avoid wrinkles or kinks in the tape.
- Ensure the joint is completely covered, extending onto the pipe as necessary.
- Indicate the location of each joint as required on the 'as-built' drawings

Note: Linerless black rubber tape (e.g. Scotch® 2242) is recommended for wrapping PEX joints. Do not use other types of tapes (e.g. duct tape, standard electrical tape) to wrap the joint, as chemicals in the adhesive may not be compatible with the polymer fitting material or the PEX tube

If linerless black rubber tape is not available, the following tapes have also been approved for protecting PowerPEX joints:

- 3M™ Temflex™ Rubber Splicing Tape 2155 or Temflex™ Cotton Friction Tape 1755
- Scotch® Rubber Splicing Tape 23 or Linerless Rubber Splicing Tape 130C

Use CAUTION when using heat-shrink tubing, as high temperatures produced by a heat gun can cause damage to PEX tubing and may cause it to pull away from the fitting.

- 
- PowerPEX is 3rd party listed and approved and has undergone extensive testing to assure the process, facility, ongoing testing and procedure exceed industry standards for PEX tube extrusion.
 - ASTM tube standards call out the wall thickness, O.D., cross-linking, out-of-round, etc. Sioux Chief continuously monitors all of these parameters to assure tube is 100% compliant.

Certifications & Listings

PowerPEX – Tested, Listed, and Trusted

Sioux Chief PowerPEX tubing and various PEX fitting systems have been certified and listed to the below. The following third party testing and listing agencies assure product is made to national standards and adhere to certain requirements set forth by those standards.

The installation instructions (section 3) should be referenced for each system type. Sioux Chief offers PowerPEX tubing and various PEX fitting systems that conform to one or more of the following referenced PEX Standards:

Standards

CSA B137.5

Thermoplastic pressure piping compendium

ANSI / NSF 14

Plastics Piping System Components and Related Materials

ANSI / NSF 61

Drinking Water System Components - Health Effects.

ASTM F876

Standard Specification for Crosslinked Polyethylene (PEX) Tubing

ASTM F877

Standard Specification for Crosslinked Polyethylene (PEX) Hot- and Cold-Water Distribution Systems

ASTM E84 & CAN/ULC S102

Standard Test Method for Surface Burning Characteristics of Building Materials

ASTM E119 & CAN/ULC S101

Standard Test Methods for Fire Tests of Building Construction and Materials

ASTM F2023

American Society for Testing and Materials Standard Test Method for Evaluating the Oxidative Resistance of Cross-linked Polyethylene (PEX) Tubing and Systems to Hot Chlorinated Water

ANSI/AWWA C904

American Water Works Association Standard for Cross-Linked Polyethylene (PEX) Pressure Tubing, ½ In. (13 mm) Through 3 In. (76 mm), for Water Service

Note: Individual fitting standards (ASTM F1807, F2159, F2080, F1960, F3347, F3348, F877, ASSE 1061) are used in conjunction with PowerPEX tubing (either Type-A or Type-B) and should be referenced for specifics on fitting dimensions and materials per each standard.

Listing Agencies

IAPMO (UPC)

Sioux Chief File Number: 8214, N-8215
Cross-linked Polyethylene (PEX)

NSF

Cross-linked Polyethylene (PEX)

INTERTEK

Sioux Chief Design Numbers: SCMC/DWP 120-01, SCMC/DWP 60-01, SCMC/DWP 60-02
Cross-linked Polyethylene (PEX)



- Sioux Chief is proud to be an American manufacturer and to support the American worker.
- Our goal is to provide better value to the plumbing contractor by offering quality products with superior customer service.
- From our headquarters in Kansas City, Missouri, Sioux Chief products are sold through qualified wholesale and retail distributors worldwide.

Warranty & Terms of Use

World-Class Products—World-Class Warranty

Warranty

Sioux Chief Mfg. Co., Inc. ("Seller" or "the Seller") warrants its products to be free from defects in material and workmanship under normal usage for the lifetime of the plumbing system in which they were originally incorporated. In the event of such defects within the warranty period, the Company will, at its option, replace or recondition the product without charge. This remedy shall be effective only if the product was installed in accordance with supplied instructions, common installation or use practices and existing building and plumbing codes and legal requirements; has not been subjected to misuse or abuse; was at all times used in a manner consistent with its intended use; was at all times used in installations and environments acceptable to its material and design specifications; or any express conditions or requirements laid out in company installation instructions, manuals, tech bulletins, special labeling, precautions, as well as other instructional documents and product limitations of use; was never modified, altered or repaired by anyone other than the Seller; was properly subjected to and passed common testing methods (including pressure testing for potable water and drainage systems) immediately after the product's installation and before the product is put into service, was not damaged by freezing temperatures or excessive heats outside normal working or any express working range of the product; was not subjected to or exposed to direct or indirect chemical exposures; was not subjected to corrosion from atmospheric or environmental degradation (including UV exposure, brackish water, acidic water (pH <6.5), alkaline water (pH >8), contaminated soils, etc.), and was protected from natural causes; was never subjected to improper protection during installation and was handled with all precautions expressly written within company limitation documents or known to the industry; was not subjected to water pressures and flow conditions outside the working limits of the product; was not subject to adverse or aggressive water conditions (during testing, through stagnation or within service life (where service-life is defined by this warranty)) and where any express water condition included within company documents is avoided; and all handling was performed in a manner consistent and known to the industry or taught through company documents, labels, websites, manuals, etc. In addition, Seller shall not be responsible for any incidental, special or consequential damages, including without limitation, lost profits or the cost of repairing or replacing other property which is damaged, other costs resulting from labor charges, delays, vandalism, negligence, fouling caused by foreign material, chemical or any other circumstances over which the Seller has no control. This warranty excludes all costs arising from routine maintenance, including the replacement of any parts required by such maintenance and the replacement of parts required by normal wear and tear. The Seller also reserves the right to modify, alter or improve its product, or parts thereof, at any time without incurring an obligation to notify or modify, alter, improve or replace any product, or parts thereof, previously sold. If, on any occasion, Seller waives any term or condition, this waiver is not to be construed as a continuing waiver. For the purposes of this warranty, the lifetime of the original plumbing system is defined as the lesser of 25 years or the time before the plumbing system was replaced or materially changed; all products with automatically or manually moving parts are excluded from the limited lifetime warranty and carry a 3-year limited warranty, subject to the remaining terms, conditions and limitations of the warranty. Some States do not allow or have other parameters governing limitations on how long an implied warranty lasts, and some States do not allow the exclusion or limitation of incidental or consequential damages. This Limited Warranty gives you specific legal rights, and you may have other rights that vary from State to State. You should consult applicable state laws to determine your rights. **THE WARRANTY SET FORTH HEREIN ABOVE AND BELOW IS GIVEN EXPRESSLY AND IS THE ONLY WARRANTY GIVEN BY THE COMPANY WITH RESPECT TO THE PRODUCT. THE COMPANY MAKES NO OTHER WARRANTIES, EXPRESS OR IMPLIED. THE COMPANY HEREBY SPECIFICALLY DISCLAIMS ALL OTHER WARRANTIES, EXPRESS OR IMPLIED, INCLUDING BUT NOT LIMITED TO THE IMPLIED WARRANTIES OF MERCHANTABILITY AND FITNESS FOR A PARTICULAR PURPOSE.**

Terms & Conditions

All sales are subject to the Standard Terms and Conditions set forth on Sioux Chief's website at www.siouxchief.com. These terms include the following:

Return Merchandise

No merchandise can be returned without Seller's prior written authorization. All returns must comply with the guidelines established below.

Return Merchandise & Warranty Service

In order to return product/merchandise or receive warranty service, Buyer must first obtain a Return Merchandise Authorization ("RMA") by contacting Seller using the following information:

MAIL: Customer Service Manager
Sioux Chief Manufacturing Company, Inc.
14940 Thunderbird Road
Kansas City, Missouri 64147

PHONE: 816-425-9900 / 1-800-821-3944

FAX: 816-348-7502 / 1-800-758-5950

EMAIL: info@siouxchief.com

Return Merchandise Procedure

All merchandise returns and warranty claims are subject to the following general terms and conditions:

RMA requests must reference Seller's order number, invoice number or the customer's P.O. number.

Minimum return amount must be \$250 net value per purchase order.

Product returns can only be made within twelve (12) months of the original invoice date of the product to Buyer.

Seller reserves the right, at its sole and absolute discretion, to reject an RMA request for any reason at any time.

In order to be received and accepted by Seller, all returned product must be in whole multiples of the Minimum Quantity listed in the current Price Index and material must be in its original packaging with manufacturer's seal intact.

Products which are being phased-out, are obsolete, or were special-order (custom) are not considered normal stock. These items are non-returnable and non-refundable, except in the case of a manufacturer's defect.

Buyer will be charged 25% of the applicable return price for product restocking.

An RMA is invalid 90 days after its date of issue.

Seller will only supply product credit for a product return or warranty claim. Issuance of an RMA does not authorize the Buyer to deduct the value of the returned item; once product is received and accepted by Seller, Seller will issue a credit memo for the returned product when applicable.

All product returns are subject to inspection and acceptance by Seller at its discretion.

Seller reserves the right to deny, nullify or cancel an RMA at its discretion.

Product returned without a Return Merchandise Authorization number will be destroyed without credit.

Seller shall not be responsible for shipping errors and shortages reported 5 days after receipt of material.

Seller shall not be responsible for shipment shortages that are signed for as clear. Any shipment that appears to be damaged in shipping must be noted when signing for receipt of delivery.

Warranty Procedure - Product & Property

All claims for property or other damage are subject to the following additional terms and procedure:

If there is a warranty claim on a part that involves property or other damage, Seller should be contacted by phone or in writing directly following the loss, and in no case later than 15 days of the date of alleged claim or failure and before any remediation or alteration of the loss site has been started; any notice beyond this time frame or after work has taken place to repair or change the loss site will materially affect the Seller's ability to adjudicate the claim and will void the warranty.

The product in claim and/or its installation should not be modified before review by Seller; alteration of the alleged product or installation materially affects the Seller's ability to establish fault and voids the warranty.

Request a claim form. Submit the completed form to the Seller. Claimant will receive an INC (incident) number from Seller.

With the INC number, claimant should submit the claim form, including the date of the installation, description of problem, damage, pictures of the product, and repair invoices. This information should be sent to the above address at claimant's expense. Seller will not receive or process a claim without an INC number.

Seller will contact claimant with next steps, which may include a visit from a site investigator or other representatives of Seller, as Seller reserves the right to investigate all alleged loss sites.

Full Freight Allowance

Sioux Chief will pay freight on all orders to single destinations totaling at least \$3,000 Net to locations within the 48 contiguous states (United States of America), at least \$6,000 Net to locations within Hawaii, Alaska, and Puerto Rico, and at least \$3,000 CAD Net to locations within Canada. Sioux Chief will pay freight on HydroTec™ and HydroBlock™ trench drain orders of at least \$5,000 Net to locations within the 48 contiguous states.

Processing of Orders

All orders are processed immediately upon receipt and acceptance by Seller. Seller reserves the right to charge back to Buyer costs incurred from order cancellations or changes, and to consider additions as separate orders.

Price Changes

All prices quoted from time to time by Seller are subject to change without notice up to time of shipment. Invoice totals and discounts will be calculated out to the sixth decimal digit. If Buyer fails to give written notice of objection to Sioux Chief's order confirmation within ten (10) days after Buyer's receipt of Sioux Chief's confirmation of the purchase order, the order confirmation pricing becomes binding.

Minimum Order Quantities

A 10% surcharge will be applied to any item not purchased in multiples of the stated Minimum Quantity, except on drop-ship orders. Items with bold Minimum Quantities in the Numerical Index (back of catalog) can never be broken. PEX tube bundles (sticks) may only be included on orders of \$40,000 Net or more. In addition, PEX tube bundles (sticks) must also be ordered in a minimum quantity of ten (10) or a \$100 surcharge will apply to the line item. Coils may be ordered in any quantity, and on orders of any amount.

TAKE THE FIELD.