







SJE-Rhombus

Pump Switch Installation Instructions

SJE-Rhombus® wide angle pump switches are designed to provide automatic control of pumps in water and sewage applications.

SJE PUMPMASTER®								SJE PUMPMASTER® PLUS								SJE PUMPMASTER® SPDT							
 <p>Mechanically activated pump switch for direct control of pumps in:</p> <ul style="list-style-type: none"> ■ Sewage ■ Water <p><small>U.S. Patent Nos. 5,087,801 & 5,142,108</small></p>								 <p>Mechanically activated pump switch for direct control of pumps in:</p> <ul style="list-style-type: none"> ■ Sewage ■ Water <p><small>U.S. Patent Nos. 5,087,801 & 5,142,108</small></p>								 <p>Mechanically activated pump switch for direct control of pumps in:</p> <ul style="list-style-type: none"> ■ Sewage ■ Water <p><small>U.S. Patent Nos. 5,087,801 & 5,142,108</small></p>							
tether length	3.5	6	10	14	18	22	24	tether length	3.5	6	10	14	18	22	24	tether length	3.5	6	10	14	18	22	24
pumping range	7	10	16	22	28	33	36	pumping range	7	10	16	22	28	33	36	pumping range	7	10	16	22	28	33	36
 <p>Mercury activated pump switch for direct control of pumps in:</p> <ul style="list-style-type: none"> ■ Sewage ■ Water ■ Non-turbulent applications <p><small>U.S. Patent Nos. 4,429,854 & 4,572,934</small></p>								 <p>Mercury activated pump and control switch for:</p> <ul style="list-style-type: none"> ■ Sewage ■ Water <p><small>U.S. Patent No. 4,302,641</small></p>								 <p>Mechanically activated pump switch for direct control of pumps in:</p> <ul style="list-style-type: none"> ■ Sewage ■ Water <p><small>U.S. Patent Nos. 5,087,801 & 5,142,108</small></p>							
tether length	3.5	6	8	10	12	15	17	tether length	3.5	5	7	9	13	15	tether length	5	10	14	18	22	max.		
pumping range	6.5	8.5	11	13	14	17	19	pumping range	6.5	7.5	8.5	11	12.5	13.5	pumping range	9	13	17	21	24			

PREVENTATIVE MAINTENANCE

- Periodically inspect the product. Check that the cable has not become worn or that the housing has not been damaged so as to impair the protection of the product. Replace the product immediately if any damage is found or suspected.
- Periodically check to see that the float is free to move and operate the switch.
- Use only SJE-Rhombus® replacement parts.
- The Junior Super Single® and Super Single® pump switches contain mercury and MUST be recycled or disposed of according to local, state, and federal codes.

SJE-RHOMBUS® FIVE-YEAR LIMITED WARRANTY

SJE-RHOMBUS® warrants to the original consumer that this product shall be free of manufacturing defects for five years after the date of consumer purchase. During that time period and subject to the conditions set forth below, SJE-RHOMBUS® will repair or replace, for the original consumer, any component which proves to be defective due to defective materials or workmanship of SJE-RHOMBUS®.

ELECTRICAL WIRING AND SERVICING OF THIS PRODUCT MUST BE PERFORMED BY A LICENSED ELECTRICIAN.

THIS WARRANTY DOES NOT APPLY: (A) to damage due to lightning or conditions beyond the control of SJE-RHOMBUS®; (B) to defects or malfunctions resulting from failure to properly install, operate or maintain the unit in accordance with printed instructions provided; (C) to failures resulting from abuse, misuse, accident, or negligence; (D) to units which are not installed in accordance with applicable local codes, ordinances, or accepted trade practices, and (E) to units repaired and/or modified without prior authorization from SJE-RHOMBUS®.

Some states do not allow limitations on how long an implied warranty lasts, so the above limitation may not apply to you. Some states do not allow the exclusion or limitation of incidental or consequential damages, so the above limitation or exclusion may not apply to you. This warranty gives you specific legal rights, and you may also have other rights which vary from state to state.

TO OBTAIN WARRANTY SERVICE: The consumer shall assume all responsibility and expense for removal, reinstallation, and freight. Any item to be repaired or replaced under this warranty must be returned to SJE-RHOMBUS®, or such place as designated by SJE-RHOMBUS®.

ANY IMPLIED WARRANTIES OF MERCHANTABILITY OR FITNESS ARE LIMITED TO THE DURATION OF THIS WRITTEN WARRANTY. SJE-RHOMBUS® SHALL NOT, IN ANY MANNER, BE LIABLE FOR ANY INCIDENTAL OR CONSEQUENTIAL DAMAGES AS A RESULT OF A BREACH OF THIS WRITTEN WARRANTY OR ANY IMPLIED WARRANTY.

NOTICE!

Products returned must be cleaned, sanitized, or decontaminated as necessary prior to shipment to ensure that employees will not be exposed to health hazards in handling said material. All applicable laws and regulations shall apply.

⚠ WARNING**ELECTRICAL SHOCK HAZARD**

Disconnect power before installing or servicing this product. A qualified service person must install and service this product according to applicable electrical and plumbing codes.

⚠ WARNING**EXPLOSION OR FIRE HAZARD**

Do not use this product with flammable liquids. Do not install in hazardous locations as defined by National Electrical Code, ANSI/NFPA 70.

Failure to follow these precautions could result in serious injury or death. Replace product immediately if switch cable becomes damaged or severed. Keep these instructions with warranty after installation. This product must be installed in accordance with National Electric Code, ANSI/NFPA 70 so as to prevent moisture from entering or accumulating within boxes, conduit bodies, fittings, float housing, or cable.

For detailed specifications on this product, or for the complete line of SJE-Rhombus® panel, alarm, and switch products, visit our web-site at www.sjrhombus.com.

MOUNTING THE SWITCH

1. Determine the required cord tether length according to product specifications on the front page and as shown in Figure A.
2. Place the cord into the clamp as shown in Figure B.
3. Locate clamp at desired activation level and secure the clamp to the discharge pipe as shown in Figure B. **Note:** Do not install cord under hose clamp.
4. Tighten the hose clamp using screwdriver. Over tightening may result in damage to the plastic clamp. Make sure the float cable is not allowed to touch the excess hose clamp band during operation.
5. Follow direct wire or piggy-back instructions for further installation.

Note: All hose clamp components are made of 18-8 stainless steel material. See your SJE-Rhombus® supplier for replacements.

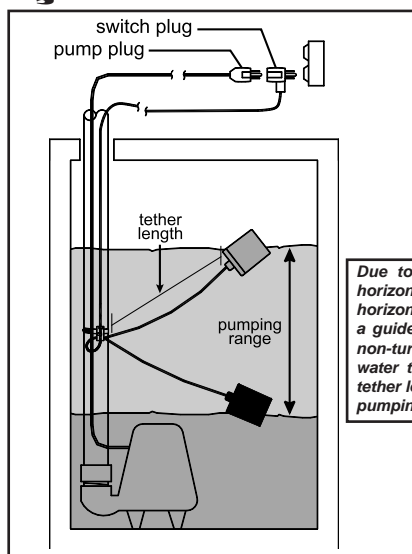
Figure A**PIGGY-BACK PLUG INSTALL**

- Electrical outlet must not be located in pump chamber.
 - Electrical outlet voltage, piggy-back plug voltage, and pump voltage must match.
1. Follow steps 1 through 4 of "Mounting The Switch."
 2. Insert switch's piggy-back plug into outlet.
 3. Plug pump into piggy-back plug as shown in Figure A.
 4. Check installation. Allow system to cycle to insure proper operation.

DIRECT WIRE INSTALL

1. Follow steps 1 through 4 of "Mounting The Switch."
2. Wire switch as shown below.
3. Check installation. Allow system to cycle to insure proper operation.

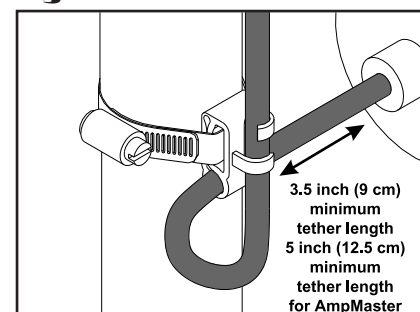
Figure B

⚠ WARNING: Tethering switches below minimum tether length can effect switch operation and will reduce the fatigue life of the cable.

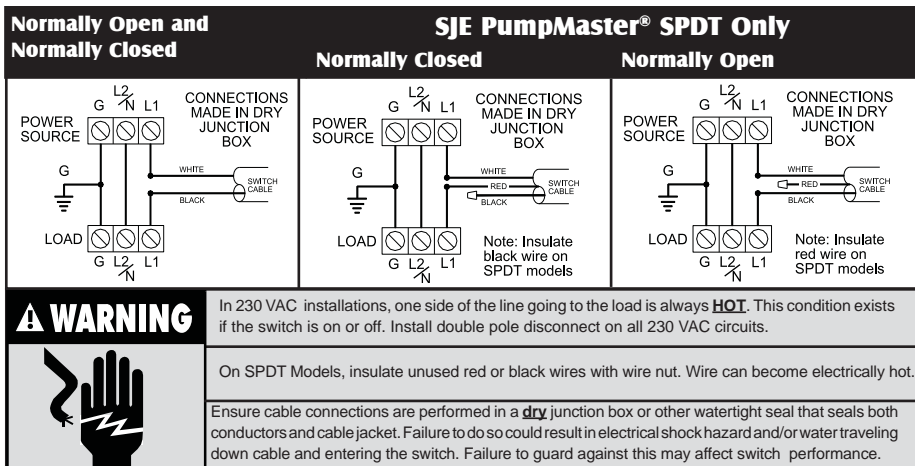

SJE-Rhombus®

22650 County Highway 6 ■ P.O. Box 1708 ■ Detroit Lakes, Minnesota 56502 USA

1-888-DIAL-SJE (1-888-342-5753) ■ Phone: 218-847-1317 ■ Fax: 218-847-4617 ■ E-mail: customer.service@sjrhombus.com

Instl. Instr. PN 1011973L
©SJE-Rhombus 05/15