

RESIDENTIAL GAS WATER HEATERS



Technical Support: 800-365-0024
Parts: 800-821-2017
www.statewaterheaters.com

GAS-FIRED



POWER VENTED GAS MODELS W/HOT SURFACE IGNITION
NOT FOR USE IN MANUFACTURED (MOBILE) HOMES

MODEL GP6 50 YTVIT SERIES 100



WARNING: If the information in these instructions is not followed exactly, a fire or explosion may result causing property damage, personal injury or death.

- Do not store or use gasoline or other flammable vapors and liquids in the vicinity of this or any other appliance.
- WHAT TO DO IF YOU SMELL GAS:
 - Do not try to light any appliance.
 - Do not touch any electrical switch; do not use any phone in your building.
 - Immediately call your gas supplier from a neighbor's phone. Follow the gas supplier's instructions.
 - If you cannot reach your gas supplier, call the fire department.
- Installation and service must be performed by a qualified installer, service agency or the gas supplier.



⚠ WARNING

Read and understand instruction manual and safety messages before installing, operating or servicing this water heater.

Failure to follow instructions and safety messages could result in death or serious injury.

Instruction manual must remain with water heater.

• **For Your Safety** •
AN ODORANT IS ADDED TO THE GAS USED
BY THIS WATER HEATER.

ALL TECHNICAL AND WARRANTY QUESTIONS: SHOULD BE DIRECTED TO THE LOCAL DEALER FROM WHOM THE WATER HEATER WAS PURCHASED. IF YOU ARE UNSUCCESSFUL, PLEASE WRITE TO THE COMPANY LISTED ON THE RATING PLATE ON THE WATER HEATER.





KEEP THIS MANUAL IN THE POCKET ON HEATER FOR FUTURE REFERENCE
WHENEVER MAINTENANCE ADJUSTMENT OR SERVICE IS REQUIRED.

SAFE INSTALLATION, USE AND SERVICE

The proper installation, use and servicing of this water heater is extremely important to your safety and the safety of others.

Many safety-related messages and instructions have been provided in this manual and on your own water heater to warn you and others of a potential injury hazard. Read and obey all safety messages and instructions throughout this manual. It is very important that the meaning of each safety message is understood by you and others who install, use, or service this water heater.

	<p>This is the safety alert symbol. It is used to alert you to potential personal injury hazards. Obey all safety messages that follow this symbol to avoid possible injury or death.</p>
---	---

	<p>DANGER indicates an imminently hazardous situation which, if not avoided, will result in injury or death.</p>
	<p>WARNING indicates a potentially hazardous situation which, if not avoided, could result in injury or death.</p>
	<p>CAUTION indicates a potentially hazardous situation which, if not avoided, could result in minor or moderate injury.</p>
	<p>CAUTION used without the safety alert symbol indicates a potentially hazardous situation which, if not avoided, could result in property damage.</p>

All safety messages will generally tell you about the type of hazard, what can happen if you do not follow the safety message, and how to avoid the risk of injury.

The California Safe Drinking Water and Toxic Enforcement Act requires the Governor of California to publish a list of substances known to the State of California to cause cancer, birth defects, or other reproductive harm, and requires businesses to warn of potential exposure to such substances.

WARNING: This product contains a chemical known to the State of California to cause cancer, birth defects, or other reproductive harm. This appliance can cause low level exposure to some of the substances listed in the Act.

IMPORTANT DEFINITIONS

- **Gas Supplier:** The Natural Gas or Propane Utility or service who supplies gas for utilization by the gas burning appliances within this application. The gas supplier typically has responsibility for the inspection and code approval of gas piping up to and including the Natural Gas meter or Propane storage tank of a building. Many gas suppliers also offer service and inspection of appliances within the building.

APPROVALS





GENERAL SAFETY INFORMATION

	⚠ WARNING
	<p>Read and understand instruction manual and safety messages before installing, operating or servicing this water heater.</p> <p>Failure to follow instructions and safety messages could result in death or serious injury.</p> <p>Instruction manual must remain with water heater.</p>

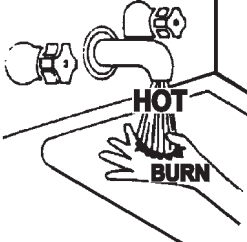
	⚠ WARNING
	Fire Hazard <p>For continued protection against risk of fire:</p> <ul style="list-style-type: none">• Do not install water heater on carpeted floor.• Do not operate water heater if flood damaged.

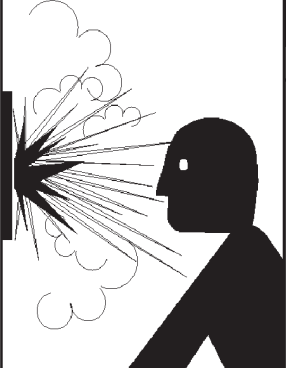
⚠ DANGER	<p>Water temperature over 125°F (52°C) can cause severe burns instantly resulting in severe injury or death.</p> <p>Children, the elderly, and the physically or mentally disabled are at highest risk for scald injury.</p> <p>Feel water before bathing or showering.</p> <p>Temperature limiting valves are available.</p> <p>Read instruction manual for safe temperature setting.</p>
	

	⚠ WARNING
	Explosion Hazard <ul style="list-style-type: none">• Overheated water can cause water tank explosion.• Properly sized temperature and pressure relief valve must be installed in opening provided.

⚠ WARNING	
Fire or Explosion Hazard	
<ul style="list-style-type: none">• Do not store or use gasoline or other flammable vapors and liquids in the vicinity of this or any other appliance.• Avoid all ignition sources if you smell LP gas.• Do not expose water heater control to excessive gas pressure.• Use only gas shown on rating plate.• Maintain required clearances to combustibles.• Keep ignition sources away from faucets after extended period of non-use.	
	<p>Read instruction manual before installing, using or servicing water heater.</p>
	

GENERAL SAFETY INFORMATION

CAUTION

Improper installation and use may result in property damage.

- Do not operate water heater if flood damaged.
- Inspect and replace anode.
- Install in location with drainage.
- Fill tank with water before operation.
- Be alert for thermal expansion.

Refer to instruction manual for installation and service.

⚠ WARNING



- Before servicing the water heater, make sure the blower assembly is unplugged or the electrical supply to the water heater is turned "OFF".
- Label all wires prior to disconnection when servicing controls. Wiring error can cause improper and dangerous operation. Verify proper operation after servicing.
- Failure to do this could result in death, serious bodily injury, or property damage.

⚠ WARNING

Breathing Hazard - Carbon Monoxide Gas

- Install vent system in accordance with codes.
- Do not operate water heater if flood damaged.
- High altitude models should be installed at elevations above 5,300 feet (1,615 m). For operation above 10,100 feet (3,079 m), a high altitude orifice must be installed.
- Do not operate if soot buildup is present.
- Do not obstruct water heater air intake with insulating jacket.
- Do not place chemical vapor emitting products near water heater.
- Gas and carbon monoxide detectors are available.
- No vent damper installation is compatible with this power vented water heater.
- Do NOT elevate any portion of the field supplied drain line beyond the 1/2" adaptor above the adaptor. This must be true for the entire length of the drain line including the exit into an appropriate drain.
- Condensate lines must be free and clear of debris and must not allow back flow through the hose. The condensate lines must be able to flow freely to an appropriate drain.
- Do not allow condensate lines to become crimped closed.
- Analyze the entire vent system to make sure that condensate will not become trapped in a section of vent pipe and therefore reduce the open cross sectional area of the vent.



Breathing carbon monoxide can cause brain damage or death.
Always read and understand instruction manual.

⚠ DANGER



⚠ Vapors from flammable liquids may explode and catch fire causing death or severe burns.

Do not use or store flammable products such as gasoline, solvents or adhesives in the same room or area near the water heater.

Keep flammable products:

1. far away from heater,
2. in approved containers,
3. tightly closed and
4. out of children's reach.

Water heater has a main burner and hot surface igniter. The hot surface igniter:

1. can come on at any time and
2. will ignite flammable vapors.

Vapors:

1. cannot be seen,
2. are heavier than air,
3. go a long way on the floor and
4. can be carried from other rooms to the hot surface igniter by air currents.

Installation:

Do not install the water heater where flammable products will be stored or used unless the main burner and hot surface igniter are

at least 18" (45.7 cm) above the floor. This will reduce, but not eliminate, the risk of vapors being ignited by the main burner or hot surface igniter.

TABLE OF CONTENTS

SAFE INSTALLATION, USE AND SERVICE.....	2	Filling the Water Heater	17-18
APPROVALS.....	2	Vent Pipe Assembly	18
GENERAL SAFETY INFORMATION.....	3-4	Venting.....	18
TABLE OF CONTENTS.....	5	Vent Pipe Termination.....	19
INTRODUCTION.....	5	Planning the Vent System.....	20
Qualified Installer or Service Agency.....	5	Condensate	20-21
Preparing for the Installation.....	5	Blower Assembly Installation	21
INSTALLATION REQUIREMENTS FOR THE COMMONWEALTH OF MASSACHUSETTS.....	6	Installation of Vent System	21
TYPICAL INSTALLATION.....	7-9	Vent Terminal Installation, Sidewall.....	21-22
Mixing Valves.....	9	Installation of Vent System, Sidewall	23
LOCATING THE NEW WATER HEATER.....	10-13	Installation of Vertical Vent System.....	23
Facts to Consider About Location.....	10-11	Vent Attenuation Assembly Installation Instructions.....	24-25
Insulation Blankets.....	11	Vent Pipe Preparation.....	26-27
Air Requirements.....	11-12	LIGHTING & OPERATING LABEL.....	28
Unconfined Space	12	TEMPERATURE REGULATION	29
Confined Space	12	FOR YOUR INFORMATION.....	30
Fresh Air Openings for Confined Spaces	12	Start Up Conditions.....	30
Outdoor Air Through Two Openings	12	Operational Conditions	30
Outdoor Air Through One Opening.....	12-13	PERIODIC MAINTENANCE.....	30-33
Outdoor Air Through Two Horizontal Ducts	13	Venting System Inspection	30
Outdoor Air Through Two Vertical Ducts.....	13	Burner Operation and Inspection.....	31
Air from Other Indoor Spaces	13	Burner Cleaning.....	31
INSTALLING THE NEW WATER HEATER	14-27	Housekeeping	31
Chemical Vapor Corrosion.....	14	Anode Rod Inspection	31
Water Piping	14	Temperature-Pressure Relief Valve Test.....	32
Space Heating & Potable Water System	14	Draining and Flushing	32
Closed Water Systems	14	Service.....	33
Thermal Expansion.....	15	LEAKAGE CHECKPOINTS.....	33
Temperature-Pressure Relief Valve	15-16	REPAIR PARTS LIST	34
High Altitude Installation	16	TROUBLESHOOTING GUIDELINES.....	35-37
Gas Piping	16-17	NOTES.....	38
Sediment Traps.....	17	LIMITED WARRANTY.....	39

INTRODUCTION

Thank You for purchasing this water heater. Properly installed and maintained, it should give you years of trouble free service.

Abbreviations Found In This Instruction Manual:

- CSA - Canadian Standards Association
- ANSI - American National Standards Institute
- NFPA - National Fire Protection Association
- ASME - American Society of Mechanical Engineers
- AHRI - Air Conditioning, Heating and Refrigeration Institute
- UL - Underwriters Laboratories Inc.

This gas-fired water heater is design certified by Underwriters Laboratories Inc. under American National Standard/CSA Standard for Gas Water Heaters ANSI Z21.10.3 • CSA 4.3 (current edition).

QUALIFIED INSTALLER OR SERVICE AGENCY

Installation and service of this water heater requires ability equivalent to that of a Qualified Agency (as defined by ANSI below) in the field involved. Installation skills such as plumbing, air supply, venting, gas supply and electrical supply are required in addition to electrical testing skills when performing service.

ANSI Z223.1 2006 Sec. 3.3.83: "Qualified Agency" - "Any individual, firm, corporation or company that either in person or through a representative is engaged in and is responsible for (a) the installation, testing or replacement of gas piping or (b) the connection, installation, testing, repair or servicing of appliances and equipment; that is experienced in such work; that is familiar with all precautions required; and that has complied with all the requirements of the authority having jurisdiction."

If you are not qualified (as defined by ANSI above) and licensed or certified as required by authority having jurisdiction to perform a given task do not attempt to perform any of the procedures described in this manual. If you do not understand the instructions given in this manual do not attempt to perform any procedures outlined in this manual.

PREPARING FOR THE INSTALLATION

1. Read "General Safety Information" section, page 3 and 4 of this manual first and then entire manual carefully. If you don't follow safety rules, the water heater will not operate properly. It could cause DEATH, SERIOUS BODILY INJURY AND/OR PROPERTY DAMAGE.

This manual contains instructions for installation, operation, and maintenance of the gas-fired water heater. It also contains warnings throughout the manual that you must read and be aware of. All warnings and all instructions are essential to proper operation of the water heater and your safety. Since we cannot put everything on the first few pages, **READ ENTIRE MANUAL BEFORE ATTEMPTING TO INSTALL OR OPERATE THE WATER HEATER.**

2. The installation must conform with these instructions and local code authority having jurisdiction. In absence of local codes, installation must comply with current editions of the National Fuel Gas Code, ANSI Z223.1/NFPA 54 and National Electrical Code, NFPA 70. All documents are available from Canadian Standards Association, 8501 East Pleasant Valley Road, Cleveland, OH 44131. NFPA documents are also available from National Fire Protection Association, 1 Batterymarch Park, Quincy, MA 02269.
3. The water heater when installed must be grounded in accordance with the local codes, or in the absence of local codes: the National Electrical Code (NFPA 70).
4. If after reading this manual you have any questions or do not understand any portion of the instructions, call the local gas utility or the manufacturer whose name appears on the rating plate.
5. Carefully plan the place where you are going to put the water heater. Correct combustion, vent action, and vent pipe installation are very important in preventing death from possible carbon monoxide poisoning and fires, see Figures 1 and 2.

Examine the location to ensure the water heater complies with the "Locating the New Water Heater" section in this manual.

6. For California installation this water heater must be braced, anchored, or strapped to avoid falling or moving during an earthquake. See instructions for correct installation procedures. Instructions may be obtained from California Office of the State Architect, 400 P Street, Sacramento, CA 95814.
7. Massachusetts Code requires this water heater to be installed in accordance with Massachusetts 248-CMR 2.00: State Plumbing Code and 248-CMR 5.00.
8. Complies with SCAQMD rule #1146 and districts having equivalent NOx requirements.

INSTALLATION REQUIREMENTS FOR THE COMMONWEALTH OF MASSACHUSETTS

COMMONWEALTH OF MASSACHUSETTS

For all side wall terminated, horizontally vented power vent, direct vent, and power direct vent gas fueled water heaters installed in every dwelling, building or structure used in whole or in part for residential purposes, including those owned or operated by the Commonwealth and where the side wall exhaust vent termination is less than seven (7) feet above finished grade in the area of the venting, including but not limited to decks and porches, the following requirements shall be satisfied:

INSTALLATION OF CARBON MONOXIDE DETECTORS

At the time of installation of the side wall horizontal vented gas fueled equipment, the installing plumber or gasfitter shall observe that a hard wired carbon monoxide detector with an alarm and battery back-up is installed on the floor level where the gas equipment is to be installed. In addition, the installing plumber or gasfitter shall observe that a battery operated or hard wired carbon monoxide detector with an alarm is installed on each additional level of the dwelling, building or structure served by the sidewall horizontal vented gas fueled equipment. It shall be the responsibility of the property owner to secure the services of qualified licensed professionals for the installation of hard wired carbon monoxide detectors.

In the event that the side wall horizontally vented gas fueled equipment is installed in a crawl space or an attic, the hard wired carbon monoxide detector with alarm and battery back-up may be installed on the next adjacent floor level.

In the event that the requirements of this subdivision can not be met at the time of completion of installation, the owner shall have a period of thirty (30) days to comply with the above requirements provided that during said thirty (30) day period, a battery operated carbon monoxide detector with an alarm shall be installed.

APPROVED CARBON MONOXIDE DETECTORS

Each carbon monoxide detector as required in accordance with the above provisions shall comply with NFPA 720 and be ANSI/UL 2034 listed and CSA certified.

SIGNAGE

A metal or plastic identification plate shall be permanently mounted to the exterior of the building at a minimum height of eight (8) feet above grade directly in line with the exhaust vent terminal for the horizontally vented gas fueled heating appliance or equipment. The sign shall read, in print size no less than one-half (1/2) inch in size, **“GAS VENT DIRECTLY BELOW. KEEP CLEAR OF ALL OBSTRUCTIONS.”**

INSPECTION

The state or local gas inspector of the side wall horizontally vented gas fueled equipment shall not approve the installation unless, upon inspection, the inspector observes carbon monoxide detectors and signage installed in accordance with the provisions of 248 CMR 5.08(2)(a) 1 through 4.

EXEMPTIONS

The following equipment is exempt from 248 CMR 5.08(2)(a)1 through 4:

1. The equipment listed in Chapter 10 entitled “Equipment Not Required To Be Vented” in the most current edition of NFPA 54 as adopted by the Board; and
2. Product Approved side wall horizontally vented gas fueled equipment installed in a room or structure separate from the dwelling, building, or structure used in whole or in part for residential purposes.

MANUFACTURER REQUIREMENTS - GAS EQUIPMENT VENTING SYSTEM PROVIDED

When the manufacturer of Product Approved side wall horizontally vented gas equipment provides a venting system design or venting system components with the equipment, the instructions provided by the manufacturer for installation of the equipment and the venting system shall include:

1. Detailed instructions for the installation of the venting system design or the venting system components; and
2. A complete parts list for the venting system design or venting system.

MANUFACTURER REQUIREMENTS - GAS EQUIPMENT VENTING SYSTEM NOT PROVIDED

When the manufacturer of a Product Approved side wall horizontally vented gas fueled equipment does not provide the parts for venting the flue gases, but identifies “special venting systems,” the following requirements shall be satisfied by the manufacturer:

1. The referenced “special venting system” instructions shall be included with the appliance or equipment installation instructions; and
2. The “special venting systems” shall be Product Approved by the Board, and the instructions for that system shall include a parts list and detailed installation instructions.

A copy of all installation instructions for all Product Approved side wall horizontally vented gas fueled equipment, all venting instructions, all parts lists for venting instructions, and/or all venting design instructions shall remain with the appliance or equipment at the completion of the installation.

TYPICAL INSTALLATION

GET TO KNOW YOUR WATER HEATER - GAS MODELS

- | | | |
|---------------------------------------|--|--|
| A Vent Pipe | Q Rating Plate | HH Bushing |
| B Anode | R Insulation | II Nipple |
| C Hot Water Outlet | S Vent Terminal | JJ Condensate Tee |
| D Outlet (120 VAC) | T Drain Valve | KK Adapter |
| F Gas Supply | U Igniter And Main Burner | LL Plug |
| G Main Manual Gas Shutoff Valve | W Drain Pan | MM Vent Pipe Assembly #1 |
| H Ground Joint Union | X Gas Control Valve/Tstat | NN Vent Pipe Assembly #2 |
| J Sediment Trap | Y Control Harness* | OO Vent Pipe Assembly #3 |
| K Outer Door | AA Motor & Blower | PP Side Recirculation Loop Inlet*** |
| L Union | CC Condensate Fitting (4 Places Shown)** | QQ Side Recirculation Loop Outlet*** (not shown) |
| M Inlet Water Shutoff Valve | DD Plastic Top | RR Vent Attenuation Assembly (VAA) (Optional) |
| N Cold Water Inlet | EE On/Off Switch | SS Access Door |
| O Inlet Dip Tube | FF Exhaust Tee | |
| P Temperature & Pressure Relief Valve | GG Elbow | |

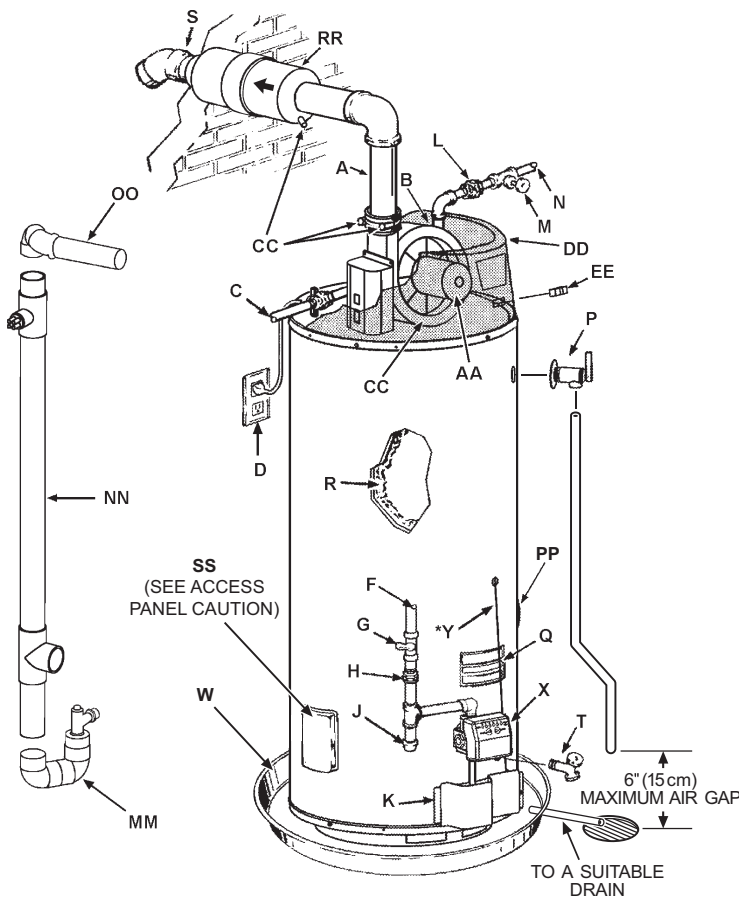

REPLACEMENT PARTS AND DELIMITING PRODUCTS

Replacement parts and recommended delimer may be ordered through authorized servicers or distributors. When ordering parts, provide complete model and serial numbers (see rating plate), quantity and name of part desired. Standard hardware items may be purchased locally.

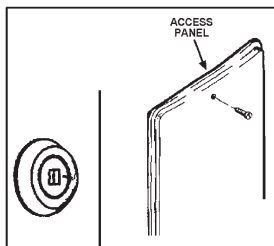
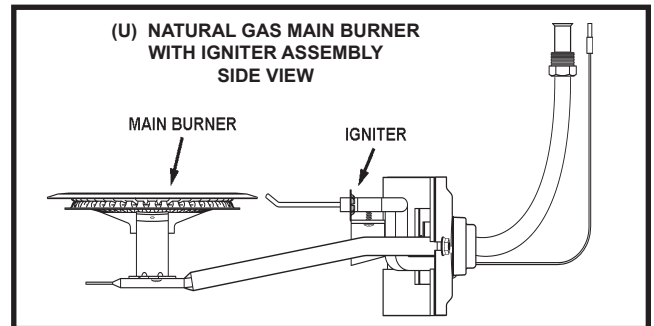
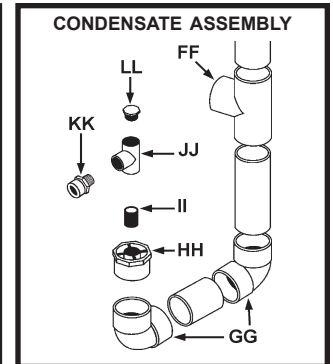
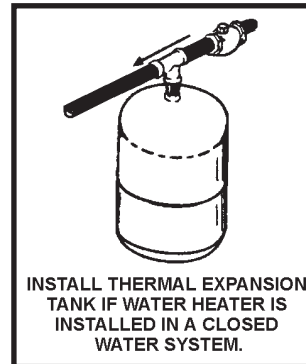

Caution: This access panel covers a 2" NPT plug that was required during the manufacturing of this water heater. This 2" NPT flange is not a cleanout fitting, removing the 2" NPT plug and using this fitting as a cleanout could void your warranty.

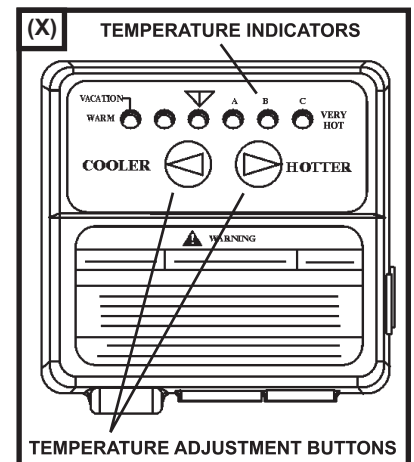
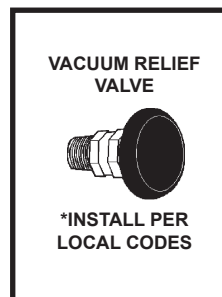

* CAUTION HARNESS HAS 120 VAC. IN OPERATION.
 ** See "PLANNING THE VENT SYSTEM", "CONDENSATE" and "BLOWER ASSEMBLY INSTALLATION" for more information.
 ***The side recirculation loop connections may *not* be used as the primary water inlet and outlet connections. For your convenience, plugs are installed in these fittings at the factory. Remove these plugs if needed for your specific installation. Otherwise (as with all connections) check for leaks while filling the tank with water and after completing the installation.

FIGURE 1

TYPICAL INSTALLATION

CONDENSATE HOSE AND DRAIN PAN

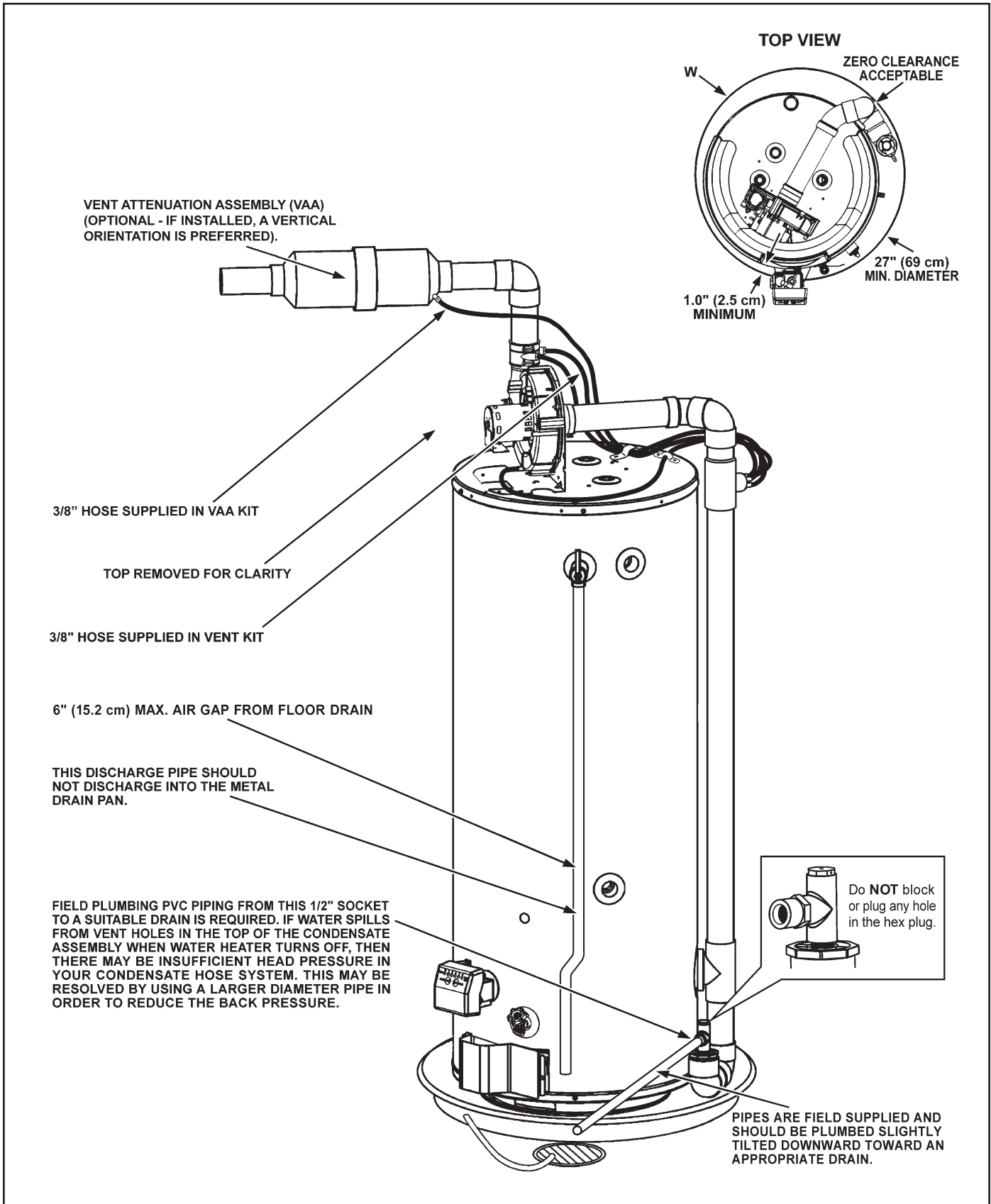

FIGURE 1A.

TYPICAL INSTALLATION

MIXING VALVE / THERMAL EXPANSION TANK USAGE AND SPACE HEATING

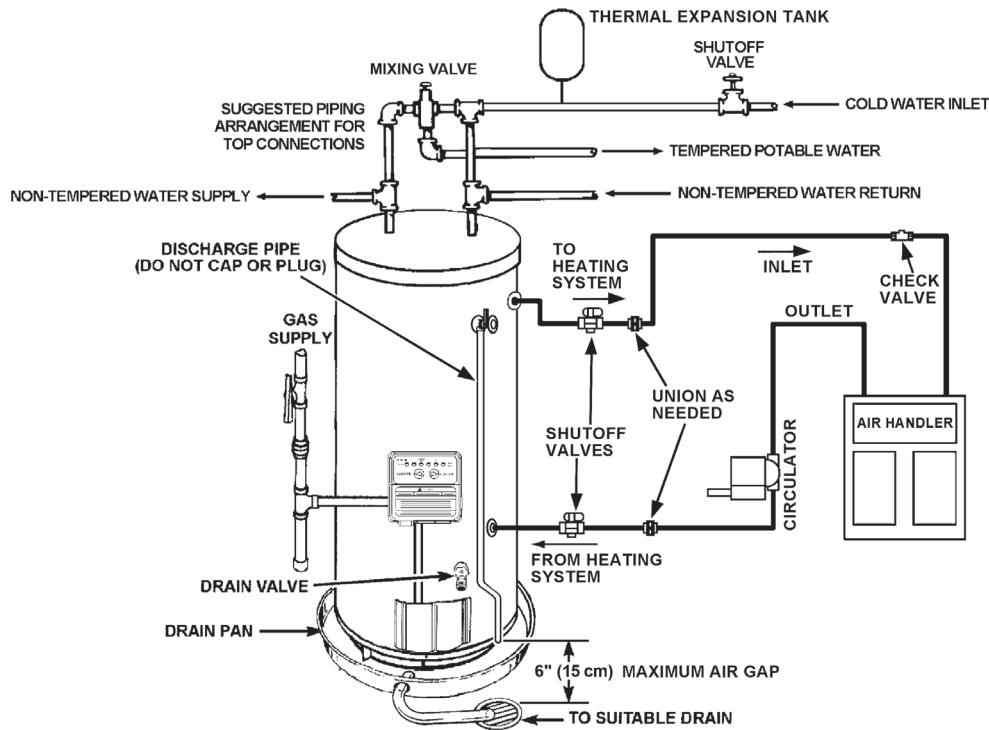

FIGURE 2.

MIXING VALVES

⚠ DANGER

Water temperature over 125°F (52°C) can cause severe burns instantly resulting in severe injury or death.

Children, the elderly and the physically or mentally disabled are at highest risk for scald injury.

Feel water before bathing or showering.

Temperature limiting devices such as mixing valves must be installed when required by codes and to ensure safe temperatures at fixtures.

Water heated to a temperature which will satisfy clothes washing, dish washing, and other sanitizing needs can scald and cause permanent injury upon contact. Short repeated heating cycles caused by small hot water uses can cause temperatures at the point of use to exceed the water heater's temperature setting by up to 20°F (11°C).

Some people are more likely to be permanently injured by hot water than others. These include the elderly, children, the infirm and the physically/mentally disabled. Table 1 shows the approximate time-to-burn relationship for normal adult skin. If anyone using hot water provided by the water heater being installed fits into one of these groups or if there is a local code or state law requiring a certain water temperature at the point of use, then special precautions must be taken.

In addition to using lowest possible temperature setting that satisfies demand of application a Mixing Valve should be installed at water

heater (see Figure 3) or at hot water taps to further reduce system water temperature.

Mixing valves are available at plumbing supply stores. Consult a Qualified Installer or Service Agency. Follow mixing valve manufacturer's instructions for installation of the valves.

TABLE 1.

Water Temperature °F	Time for 1 st Degree Burns (Less Severe Burns)	Time for Permanent Burns 2 nd & 3 rd Degree (Most Severe Burns)
110	(normal shower temp.)	
116	(pain threshold)	
116	35 minutes	45 minutes
122	1 minute	5 minutes
131	5 seconds	25 seconds
140	2 seconds	5 seconds
149	1 second	2 seconds
154	instantaneous	1 seconds

(U.S. Government Memorandum, C.P.S.C., Peter L. Armstrong, Sept. 15, 1978)

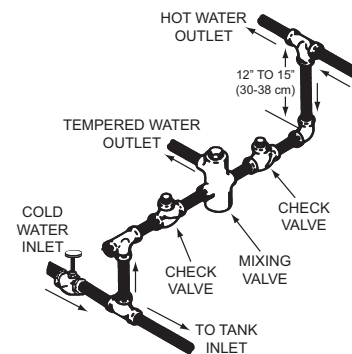

FIGURE 3.

LOCATING THE NEW WATER HEATER

FACTS TO CONSIDER ABOUT THE LOCATION

Carefully choose an indoor location for the new water heater, because the placement is a very important consideration for the safety of the occupants in the building and for the most economical use of the appliance. **This water heater is not for use in manufactured (mobile) homes or outdoor installation.**

Whether replacing an old water heater or putting the water heater in a new location, the following critical points must be observed:

1. Select a location indoors as close as practical to the vent terminal or location to which the water heater vent piping is going to be connected, and as centralized with the water piping system as possible.
2. Selected location must provide adequate clearances for servicing and proper operation of the water heater.

CAUTION

Property Damage Hazard

- All water heaters eventually leak.
- Do not install without adequate drainage.

Installation of the water heater must be accomplished in such a manner that if the tank or any connections should leak, the flow will not cause damage to the structure. For this reason, it is not advisable to install the water heater in an attic or upper floor. When such locations cannot be avoided, a metal drain pan should be installed under the water heater. Drain pans are available at your local hardware store. Such a drain pan must have a clearance of at least 1.0" (2.5cm) greater than any point on the water heater's outer jacket and must be piped to an adequate drain. The pan must not restrict combustion air flow. For example, if a circular pan is used, it must be a minimum of 27" (69cm) in diameter. See Figure 1.

Water heater life depends upon water quality, water pressure and the environment in which the water heater is installed. Water heaters are sometimes installed in locations where leakage may result in property damage, even with the use of a drain pan piped to a drain. However, unanticipated damage can be reduced or prevented by a leak detector or water shutoff device used in conjunction with a piped drain pan. These devices are available from some plumbing supply wholesalers and retailers, and detect and react to leakage in various ways:

- Sensors mounted in the drain pan that trigger an alarm or turn off the incoming water to the water heater when leakage is detected.
- Sensors mounted in the drain pan that turn off the water supply to the entire building when water is detected in the drain pan.
- Water supply shutoff devices that activate based on the water pressure differential between the cold water and hot water pipes connected to the water heater.
- Devices that will turn off the gas supply to a gas water heater while at the same time shutting off its water supply.

INSTALLATIONS IN AREAS WHERE FLAMMABLE LIQUIDS (VAPORS) ARE LIKELY TO BE PRESENT OR STORED (GARAGES, STORAGE AND UTILITY AREAS, ETC.): Flammable liquids (such as gasoline, solvents, propane (LP or butane, etc.) and other substances (such as adhesives, etc.) emit flammable vapors which can be ignited by a gas water heater's hot surface igniter or main burner. The resulting flashback and fire can cause death or serious burns to anyone in the area.

Also, the water heater must be located and/or protected so it is not subject to physical damage by a moving vehicle.

WARNING

Fire or Explosion Hazard

- Do not store or use gasoline or other flammable vapors and liquids in the vicinity of this or any other appliance.
- Avoid all ignition sources if you smell LP gas.
- Do not expose water heater control to excessive gas pressure.
- Use only gas shown on rating plate.
- Maintain required clearances to combustibles.
- Keep ignition sources away from faucets after extended period of non-use.



Read instruction manual before installing, using or servicing water heater.



DANGER



Vapors from flammable liquids may explode and catch fire causing death or severe burns.

Water heater has a main burner and hot surface igniter. The hot surface igniter:

1. can come on at any time and
2. will ignite flammable vapors.

Do not use or store flammable products such as gasoline, solvents or adhesives in the same room or area near the water heater.

Vapors:

1. cannot be seen,
2. are heavier than air,
3. go a long way on the floor and
4. can be carried from other rooms to the hot surface igniter by air currents.

Keep flammable products:

1. far away from heater,
2. in approved containers,
3. tightly closed and
4. out of children's reach.

Installation:

Do not install the water heater where flammable products will be stored or used unless the main burner and hot surface igniter are

at least 18" (45.7cm) above the floor. This will reduce, but not eliminate, the risk of vapors being ignited by the main burner or hot surface igniter.



WARNING

Fire Hazard

For continued protection against risk of fire:

- Do not install water heater on carpeted floor.
- Do not operate water heater if flood damaged.

This water heater must not be installed directly on carpeting. Carpeting must be protected by metal or wood panel beneath the appliance extending beyond the full width and depth of the appliance by at least 3" (7.6 cm) in any direction, or if the appliance is installed

in an alcove or closet, the entire floor must be covered by the panel. Failure to heed this warning may result in a fire hazard.

! WARNING

Fire or Explosion Hazard



Read instruction manual before installing, using or servicing water heater.

- Improper use may result in fire or explosion.
- Maintain required clearances to combustibles.



Minimum clearances between water heater and combustible construction are 0 inch at the sides and rear, 5.5" (14.0 cm) from the front and 12" (30.5 cm) from top. (Standard clearance.) If clearances stated on the heater differ from standard clearances, install water heater according to clearances stated on the heater.

Adequate clearance 24" (61.0 cm) for servicing this appliance should be considered before installation, such as changing the anodes, etc.

A minimum clearance of 5.5" (14.0 cm) must be allowed for access to replaceable parts such as thermostats, drain valve, relief valve and condensate drain.

When installing the heater, consideration must be given to proper location. Location selected should be as close to the wall as practicable and as centralized with the water piping system as possible.

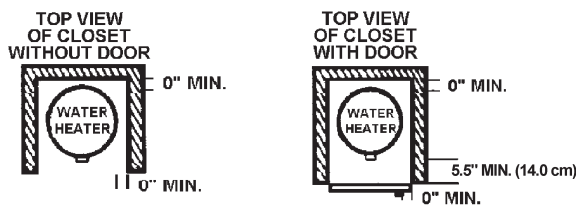



FIGURE 4.

A gas water heater cannot operate properly without the correct amount of air for combustion. Do not install in a confined area such as a closet, unless you provide air as shown in the "Locating The New Water Heater" section. Never obstruct the flow of ventilation air. If you have any doubts or questions at all, call your gas supplier. Failure to provide the proper amount of combustion air can result in a fire or explosion and cause death, serious bodily injury, or property damage.

! WARNING

Breathing Hazard - Carbon Monoxide Gas



- Install water heater in accordance with the instruction manual and NFPA 54
- To avoid injury, combustion and ventilation air must be taken from outdoors.
- Do not place chemical vapor emitting products near water heater.

Breathing carbon monoxide can cause brain damage or death. Always read and understand instruction manual.

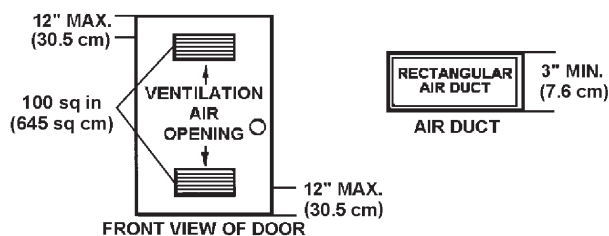

FIGURE 5.

If this water heater will be used in beauty shops, barber shops, cleaning establishments, or self-service laundries with dry cleaning equipment, it is imperative that the water heater or water heaters be installed so that combustion and ventilation air be taken from outside these areas.

Propellants of aerosol sprays and volatile compounds, (cleaners, chlorine based chemicals, refrigerants, etc.) in addition to being highly flammable in many cases, will also react to form corrosive hydrochloric acid when exposed to the combustion products of the water heater. The results can be hazardous, and also cause product failure.

INSULATION BLANKETS

Insulation blankets are available to the general public for external use on gas water heaters but are not necessary with these products. The purpose of an insulation blanket is to reduce standby heat loss encountered with storage tank heaters. Your water heater meets or exceeds the Energy Policy Act standards with respect to insulation and standby loss requirements, making an insulation blanket unnecessary.

Should you choose to apply an insulation blanket to this heater, you should follow these instructions (For identification of components mentioned below, see Figure 1). Failure to follow these instructions can restrict the air flow required for proper combustion, potentially resulting in fire, asphyxiation, serious personal injury or death.

! WARNING

Breathing Hazard - Carbon Monoxide Gas



- Do not obstruct water heater air intake with insulating blanket.
- Gas and carbon monoxide detectors are available.
- Install water heater in accordance with the instruction manual.

Breathing carbon monoxide can cause brain damage or death. Always read and understand instruction manual.

- Do not apply insulation to the top of the water heater, as this will interfere with safe operation of the blower assembly.
- Do not cover the outer door, thermostat or temperature & pressure relief valve.
- Do not allow insulation to come within 2" (5.1 cm) of the floor to prevent blockage of combustion air flow to the burner.
- Do not cover the instruction manual. Keep it on the side of the water heater or nearby for future reference.
- Do obtain new warning and instruction labels from the manufacturer for placement on the blanket directly over the existing labels.
- Do inspect the insulation blanket frequently to make certain it does not sag, thereby obstructing combustion air flow.

AIR REQUIREMENTS

! WARNING

Breathing Hazard - Carbon Monoxide Gas



- Install water heater in accordance with the instruction manual and NFPA 54
- To avoid injury, combustion and ventilation air must be taken from outdoors.
- Do not place chemical vapor emitting products near water heater.

Breathing carbon monoxide can cause brain damage or death. Always read and understand instruction manual.

For safe operation an adequate supply of fresh uncontaminated air for combustion and ventilation must be provided.

An insufficient supply of air can cause recirculation of combustion products resulting in contamination that may be hazardous to life.

Such a condition often will result in a yellow, luminous burner flame, causing sooting of the combustion chamber, burners and flue tubes and creates a risk of asphyxiation.

Do not install the water heater in a confined space unless an adequate supply of air for combustion and ventilation is brought in to that space using the methods described in the Confined Space section that follows.

Never obstruct the flow of ventilation air. If you have any doubts or questions at all, call your gas supplier. Failure to provide the proper amount of combustion air can result in a fire or explosion and cause property damage, serious bodily injury or death.

UNCONFINED SPACE

An Unconfined Space is one whose volume is not less than 50 cubic feet per 1,000 Btu/hr (4.8 cubic meters per kW) of the total input rating of all appliances installed in the space. Rooms communicating directly with the space, in which the appliances are installed, through openings not furnished with doors, are considered a part of the unconfined space.

Makeup air requirements for the operation of exhaust fans, kitchen ventilation systems, clothes dryers and fireplaces should also be considered in determining the adequacy of a space to provide combustion, ventilation and dilution air.

UNUSUALLY TIGHT CONSTRUCTION

In unconfined spaces in buildings, infiltration may be adequate to provide air for combustion, ventilation and dilution of flue gases. However, in buildings of unusually tight construction (for example, weather stripping, heavily insulated, caulked, vapor barrier, etc.) additional air must be provided using the methods described in the Confined Space section that follows.

CONFINED SPACE

A Confined Space is one whose volume is less than 50 cubic feet per 1,000 Btu/hr (4.8 cubic meters per kW) of the total input rating of all appliances installed in the space.

Openings must be installed to provide fresh air for combustion, ventilation and dilution in confined spaces. The required size for the openings is dependent on the method used to provide fresh air to the confined space and the total Btu/hr input rating of all appliances installed in the space.

DIRECT VENT APPLIANCES

Appliances installed in a Direct Vent configuration that derive all air for combustion from the outdoor atmosphere through sealed intake air piping are not factored in the total appliance input Btu/hr calculations used to determine the size of openings providing fresh air into confined spaces.

EXHAUST FANS

Where exhaust fans are installed, additional air should be provided to replace the exhausted air. When an exhaust fan is installed in the same space with a water heater, sufficient openings to provide fresh air must be provided that accommodate the requirements for all appliances in the room and the exhaust fan. Undersized openings will cause air to be drawn into the room through the water heater's vent system causing poor combustion. Sooting, serious damage to the water heater and the risk of fire or explosion may result. It can also create a risk of asphyxiation.

LOUVERS AND GRILLES

The free areas of fresh air openings in instructions that follow do not take in to account presence of louvers, grilles or screens in openings.

The required size of openings for combustion, ventilation and dilution air should be based on the "net free area" of each opening. Where the free area through a design of louver or grille or screen is known, it should be used in calculating the size of opening required to provide the free area specified. Where the louver and grille design and free area are not known, it should be assumed that wood louvers will have 25%

free area and metal louvers and grilles will have 75% free area. Non motorized louvers and grilles should be fixed in the open position.

FRESH AIR OPENINGS FOR CONFINED SPACES

The following instructions should be used to calculate the size, number and placement of openings providing fresh air for combustion, ventilation and dilution in confined spaces. The illustrations shown in this section of the manual are a reference for the openings that provide fresh air into confined spaces only. Do not refer to these illustrations for the purpose of vent installation. See Installation of Vent System on pages 18-27 for complete venting installation instructions.

OUTDOOR AIR THROUGH TWO OPENINGS

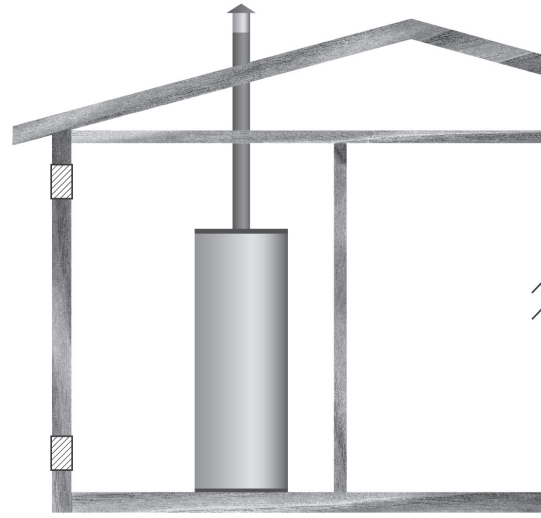

FIGURE 6.

The confined space should be provided with two permanent openings, one commencing within 12 inches (300 mm) of the top and one commencing within 12 inches (300 mm) of the bottom of the enclosure. The openings should communicate directly with the outdoors. See Figure 6.

Each opening should have a minimum free area of 1 square inch per 4,000 Btu/hr (550 mm² per kW) of the aggregate input rating of all appliances installed in the enclosure. Each opening should not be less than 100 square inches (645 cm²).

OUTDOOR AIR THROUGH ONE OPENING

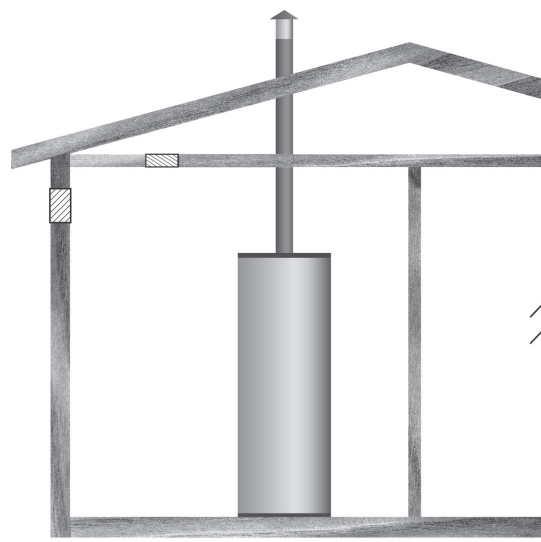

FIGURE 7.

Alternatively a single permanent opening, commencing within 12 inches (300 mm) of the top of the enclosure, should be provided. See

Figure 7. The water heater should have clearances of at least 1 inch (25 mm) from the sides and back and 6 inches (150 mm) from the front of the appliance. The opening should directly communicate with the outdoors or should communicate through a vertical or horizontal duct to the outdoors or spaces that freely communicate with the outdoors and should have a minimum free area of the following:

1. 1 square inch per 3000 Btu/hr (700 mm² per kW) of the total input rating of all appliances located in the enclosure, and
2. Not less than the sum of the areas of all vent connectors in space.

OUTDOOR AIR THROUGH TWO HORIZONTAL DUCTS

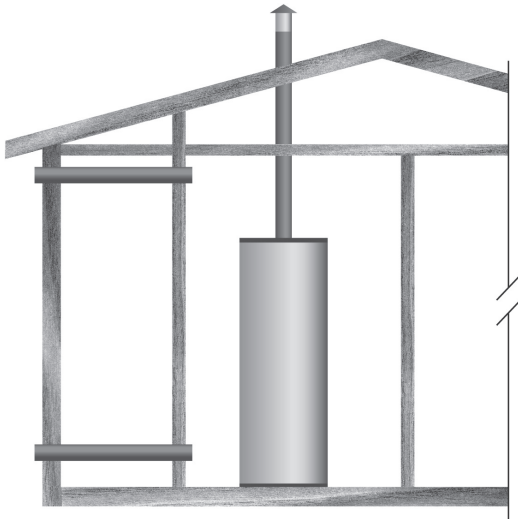

FIGURE 8.

Confined space should be provided with two permanent horizontal ducts, one commencing within 12 inches (300 mm) of top and one commencing within 12 inches (300 mm) of bottom of enclosure. Horizontal ducts should communicate directly with outdoors. See Figure 8.

Each duct opening should have a minimum free area of 1 square inch per 2,000 Btu/hr (1100 mm² per kW) of the aggregate input rating of all appliances installed in the enclosure.

When ducts are used, they should be of the same cross sectional area as the free area of the openings to which they connect. The minimum dimension of rectangular air ducts should be not less than 3 inches.

OUTDOOR AIR THROUGH TWO VERTICAL DUCTS

The illustrations shown in this section of the manual are a reference for the openings that provide fresh air into confined spaces only.

Do not refer to these illustrations for the purpose of vent installation. See Installation of Vent System on pages 18-27 for complete venting installation instructions.

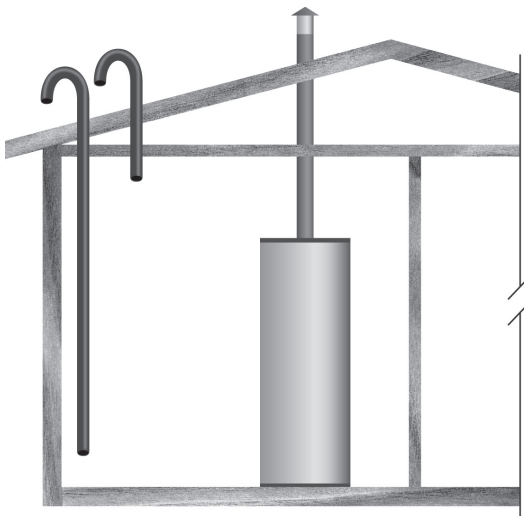

FIGURE 9.

The confined space should be provided with two permanent vertical ducts, one commencing within 12 inches (300 mm) of the top and one commencing within 12 inches (300 mm) of the bottom of the enclosure. The vertical ducts should communicate directly with the outdoors. See Figure 9.

Each duct opening should have a minimum free area of 1 square inch per 4,000 Btu/hr (550 mm² per kW) of the aggregate input rating of all appliances installed in the enclosure.

When ducts are used, they should be of the same cross sectional area as the free area of the openings to which they connect. The minimum dimension of rectangular air ducts should be not less than 3 inches.

AIR FROM OTHER INDOOR SPACES

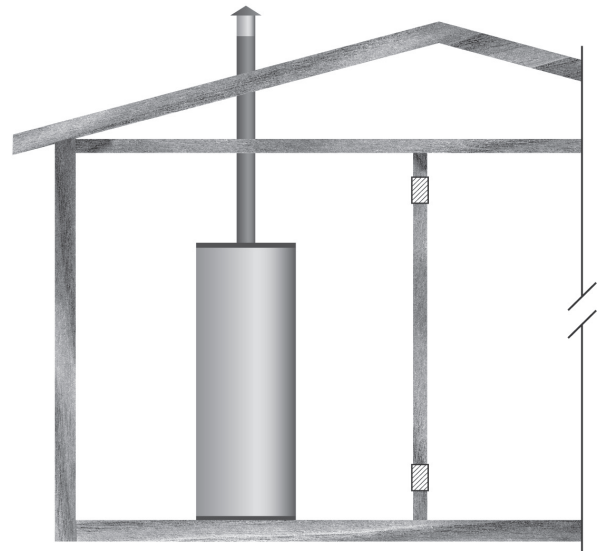

FIGURE 9A.

The confined space should be provided with two permanent openings, one commencing within 12 inches (300 mm) of the top and one commencing within 12 inches (300 mm) of the bottom of the enclosure. See Figure 9A.

Each opening should communicate directly with an additional room(s) of sufficient volume so that the combined volume of all spaces meets the criteria for an Unconfined Space.

Each opening should have a minimum free area of 1 square inch per 1,000 Btu/hr (1100 mm² per kW) of the aggregate input rating of all appliances installed in the enclosure. Each opening should not be less than 100 square inches (645 cm²).

INSTALLING THE NEW WATER HEATER

CHEMICAL VAPOR CORROSION

CORROSION OF THE FLUEWAYS AND VENT SYSTEM MAY OCCUR IF AIR FOR COMBUSTION CONTAINS CERTAIN CHEMICAL VAPORS. SUCH CORROSION MAY RESULT IN FAILURE AND RISK OF ASPHYXIATION.

Spray can propellants, cleaning solvents, refrigerator and air conditioning refrigerants, swimming pool chemicals, calcium and sodium chloride (water softener salt), waxes, and process chemicals are typical compounds which are potentially corrosive.

Do not store products of this sort near the heater. Also, air which is brought in contact with the heater should not contain any of these chemicals. If necessary, uncontaminated air should be obtained from remote or outside sources. The limited warranty is voided when failure of water heater is due to a corrosive atmosphere. (See limited warranty for complete terms and conditions).

WATER PIPING

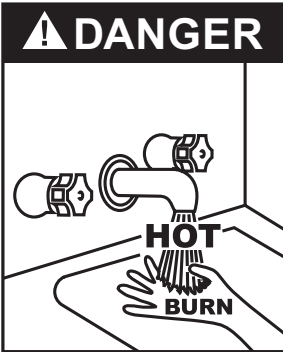
	<p>⚠ DANGER</p> <p>Water temperature over 125°F (52°C) can cause severe burns instantly resulting in severe injury or death.</p> <p>Children, the elderly and the physically or mentally disabled are at highest risk for scald injury.</p> <p>Feel water before bathing or showering.</p> <p>Temperature limiting valves are available.</p> <p>Read instruction manual for safe temperature setting.</p>
--	--

HOTTER WATER CAN SCALD:

Water heaters are intended to produce hot water. Water heated to a temperature which will satisfy space heating, clothes washing, dish washing, cleaning and other sanitizing needs can scald and permanently injure you upon contact. Some people are more likely to be permanently injured by hot water than others. These include the elderly, children, the infirm, or physically/mentally handicapped. If anyone using hot water fits into one of these groups or if there is a local code or state law requiring a certain temperature water at the hot water tap, then you must take special precautions. In addition to using lowest possible temperature setting that satisfies your hot water needs, a means such as a mixing valve, should be used at hot water taps used by these people or at the water heater, see Figure 2. Valves for reducing point of use temperature by mixing cold and hot water are also available:

Consult a Qualified Installer or Service Agency. Follow manufacturer's instructions for installation of valves. Before changing the factory setting on thermostat, read "Temperature Regulation" section in this manual.

<p>⚠ WARNING</p> <p>Toxic Chemical Hazard</p> <ul style="list-style-type: none">• Do not connect to non-potable water system.

This water heater should not be connected to any heating systems or component(s) used with a non-potable water heating appliance.

All piping components connected to this unit for space heating applications should be suitable for use with potable water.

Toxic chemicals, such as those used for boiler treatment should not be introduced into this system.

When the system requires water for space heating at temperatures higher than required for domestic water purposes, a mixing valve must be installed. Please refer to Figure 2 for suggested piping arrangement.

SPACE HEATING AND POTABLE WATER SYSTEM

This appliance has been design certified as complying with American National Standard/CSA Standard for water heaters and is considered suitable for Water (Potable) Heating and Space Heating.

Your water heater is equipped with inlet/outlet connections for use in space heating applications (see Figure 2). If this water heater is to be used to supply both space heating and potable (drinking) water, the instructions listed below must be followed:

- Be sure to follow the manual(s) shipped with the air handler or other type heating system.
- This water heater is not to be used as a replacement for an existing boiler installation.
- Do not use with piping that has been treated with chromates, boiler seal or other chemicals and do not add any chemicals to the water heater piping
- If the space heating system requires water temperatures in excess of 120°F (49°C), a mixing valve must be installed per the manufacturer's instructions in the potable hot water supply to limit the risk of scald injury.
- Pumps, valves, piping and fittings must be compatible with potable water.
- A properly installed flow control valve is required to prevent thermosiphoning. Thermosiphoning is the result of a continuous flow of water through the air handler circuit during the off cycle. Weeping (blow off) of the temperature and pressure relief valve (T & P) or higher than normal water temperatures are the first signs of thermosiphoning.
- The hot water line from the water heater should be vertical past any mixing valve or supply line to the heating system to remove air bubbles from the system.
- Do not connect the water heater to any system or components previously used with non-potable water heating appliances when used to supply potable water.

CLOSED WATER SYSTEMS

Water supply systems may, because of code requirements or such conditions as high line pressure, among others, have installed devices such as pressure reducing valves, check valves, and back flow preventers. Devices such as these cause the water system to be a closed system.

THERMAL EXPANSION

As water is heated, it expands (thermal expansion). In a closed system the volume of water will grow when it is heated. As the volume of water grows there will be a corresponding increase in water pressure due to thermal expansion. Thermal expansion can cause premature tank failure (leakage). This type of failure is not covered under the limited warranty. Thermal expansion can also cause intermittent Temperature-Pressure Relief Valve operation: water discharged from valve due to excessive pressure build up. This condition is not covered under the limited warranty. The Temperature-Pressure Relief Valve is not intended for constant relief of thermal expansion.

A properly sized thermal expansion tank must be installed on all closed systems to control the harmful effects of thermal expansion. Contact a local plumbing service agency to have a thermal expansion tank installed.

NOTE: To protect against untimely corrosion of hot and cold water fittings, it is strongly recommended that di-electric unions or couplings be installed on this water heater when connected to copper pipe.

All gas piping must comply with local codes and ordinances or with the National Fuel Gas Code (ANSI Z223.1/ NFPA-54). Copper and brass tubing and fittings (except tin lined copper tubing) should not be used.

CAUTION

Property Damage Hazard

- Avoid water heater damage.
- Install thermal expansion tank if necessary.
- Do not apply heat to cold water inlet.
- Contact qualified installer or service agency.

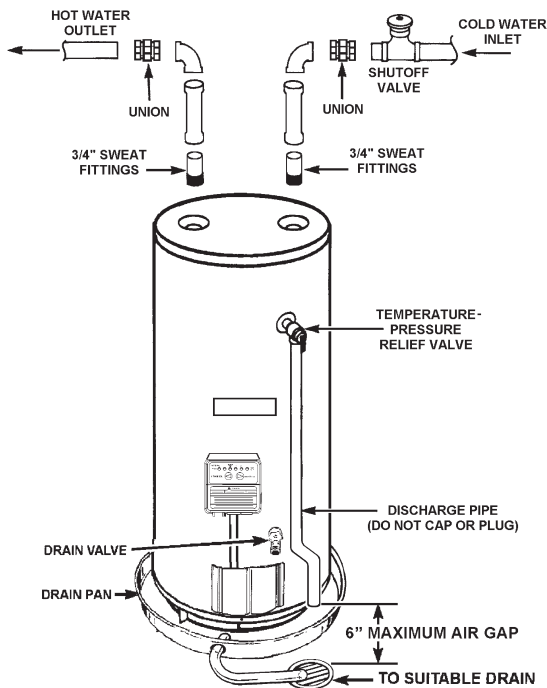

FIGURE 10.

Figure 10 shows typical attachment of water piping to the water heater. The water heater is equipped with 3/4 inch NPT water connections.

NOTE: If using copper tubing, solder tubing to an adapter before attaching the adapter to the water heater connections. Do not solder the water lines directly to the water heater connections. It will harm the dip tube and damage the tank.

T & P Valve and Pipe Insulation

1. Locate the temperature and pressure relief valve on the water heater (also known as a T&P relief valve). See Figure 11.
2. Locate the slit running the length of the T&P relief valve insulation.
3. Spread the slit open and fit the insulation over the T&P relief valve. See Figure 11. Apply gentle pressure to the insulation to ensure that it is fully seated on the T&P Relief Valve. Once seated, secure the insulation with

duct tape, electrical tape, or equivalent. **IMPORTANT:** The insulation and tape must not block the discharge opening or hinder access to the manual relief lever (Figure 11). Ensure a discharge pipe is installed into the T&P valve discharge opening per the instructions in this manual.

4. Locate the hot water (outlet) & cold water (inlet) pipes to the water heater.
5. Locate the slit running the length of a section of pipe insulation.
6. Spread the slit open and slip the insulation over the cold water (inlet) pipe. Apply gentle pressure along the length of the insulation to ensure that it is fully seated around the pipe. Also, ensure that the base of the insulation is flush with the water heater. Once seated, secure the insulation with duct tape, electrical tape, or equivalent.
7. Repeat steps 5 and 6 for the hot water (outlet) pipe.
8. Add additional sections of pipe insulation as needed.

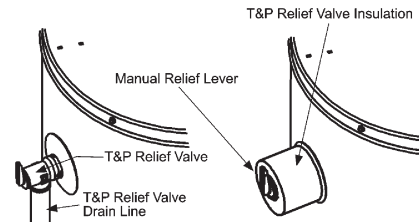

FIGURE 11.

TEMPERATURE-PRESSURE RELIEF VALVE

WARNING

Explosion Hazard

- Temperature-Pressure Relief Valve must comply with ANSI Z21.22- CSA 4.4 and ASME code.
- Properly sized Temperature-Pressure Relief Valve must be installed in opening provided.
- Can result in overheating and excessive tank pressure.
- Can cause serious injury or death.

This water heater is provided with a properly rated/sized and certified combination Temperature-Pressure Relief Valve (T&P valve) by the manufacturer. The valve is certified by a nationally recognized testing laboratory that maintains periodic inspection of production of listed equipment of materials as meeting the requirements for Relief Valves for Hot Water Supply Systems, ANSI Z21.22 • CSA 4.4, and the code requirements of ASME.

If replaced, the new T&P valve must meet the requirements of local codes, but not less than a combination Temperature-Pressure Relief Valve rated/sized and certified as indicated in the above paragraph. The new valve must be marked with a maximum set pressure not to exceed the marked hydrostatic working pressure of the water heater (150 psi = 1,035 kPa) and a discharge capacity not less than the water heater Btu/hr or kW input rate as shown on the water heater's model rating plate.

Note: In addition to the factory installed Temperature-Pressure Relief Valve on the water heater, each remote storage tank that may be installed and piped to a water heating appliance must also have its own properly sized, rated and approved Temperature-Pressure Relief Valve installed. Call the toll free technical support phone number listed on the back cover of this manual for technical assistance in sizing a Temperature-Pressure Relief Valve for remote storage tanks.

For safe operation of the water heater, the Temperature-Pressure Relief Valve must not be removed from its designated opening nor plugged. The Temperature-Pressure Relief Valve must be installed directly into the fitting of the water heater designed for the relief valve. Install discharge piping so that any discharge will exit the pipe within 6 inches (15.2 cm) above an adequate floor drain, or external to the building. In cold climates it is recommended that it be terminated at an adequate drain inside the building. Be certain that no contact is made with any live electrical part. The

discharge opening must not be blocked or reduced in size under any circumstances. Excessive length, over 30 feet (9.14 m), or use of more than four elbows can cause restriction and reduce the discharge capacity of the valve.

No valve or other obstruction is to be placed between the Temperature-Pressure Relief Valve and the tank. Do not connect discharge piping directly to the drain unless a 6" (15.2 cm) air gap is provided. To prevent bodily injury, hazard to life, or property damage, the relief valve must be allowed to discharge water in adequate quantities should circumstances demand. If the discharge pipe is not connected to a drain or other suitable means, the water flow may cause property damage.

CAUTION
Water Damage Hazard
<ul style="list-style-type: none"> • Temperature-Pressure Relief Valve discharge pipe must terminate at adequate drain.

T&P Valve Discharge Pipe Requirements:

- Should not be smaller in size than the outlet pipe size of the valve, or have any reducing couplings or other restrictions.
- Should not be plugged or blocked.
- Should not be exposed to freezing temperatures.
- Should be of material listed for hot water distribution.
- Should be installed so as to allow complete drainage of both the Temperature-Pressure Relief Valve and the discharge pipe.
- Must terminate a maximum of six inches above a floor drain or external to the building. In cold climates, it is recommended that the discharge pipe be terminated at an adequate drain inside the building.
- Should not have any valve or other obstruction between the relief valve and the drain.

⚠ DANGER	<ul style="list-style-type: none"> • Burn hazard. • Hot water discharge. • Keep clear of Temperature-Pressure Relief Valve discharge outlet.

The Temperature-Pressure Relief Valve must be manually operated at least twice a year. Caution should be taken to ensure that (1) no one is in front of or around the outlet of the Temperature-Pressure Relief Valve discharge line, and (2) the water manually discharged will not cause any bodily injury or property damage because the water may be extremely hot. If after manually operating the valve, it fails to completely reset and continues to release water, immediately close the cold water inlet to the water heater, follow the draining instructions in this manual, and replace the Temperature-Pressure Relief Valve with a properly rated/sized new one.

NOTE: The purpose of a Temperature-Pressure Relief Valve is to prevent excessive temperatures and pressures in the storage tank. The T&P valve is not intended for the constant relief of thermal expansion. A properly sized thermal expansion tank must be installed on all closed systems to control thermal expansion, see Closed Water Systems and Thermal Expansion on page 14 and 15.

If you do not understand these instructions or have any questions regarding the Temperature-Pressure Relief Valve call the toll free number listed on the back cover of this manual for technical assistance.

HIGH ALTITUDE INSTALLATION

⚠ WARNING	
Breathing Hazard - Carbon Monoxide Gas	
	<ul style="list-style-type: none"> • High altitude models should be installed at elevations above 5,300 feet (1,615 m). For operation above 10,100 feet (3,079 m), a high altitude orifice must be installed. • Contact a qualified installer or service agency.
Breathing carbon monoxide can cause brain damage or death. Always read and understand instruction manual.	

This heater is approved for operation up to 5,300 feet (1,615 m) without alteration. High altitude models are available from the factory for elevations between 5,300 feet (1,615 m) and 10,100 feet (3,079 m). For elevations above 10,100 feet (3,079 m) the input rating should be reduced at the rate of 4 percent for each 1,000 feet (305 m) above sea level which requires replacement of the burner orifice in accordance with National Fuel Gas Code (ANSI Z223.1/NFPA 54). Contact your local gas supplier for further information.

Failure to replace standard orifice with a high altitude orifice when installed above 10,100 feet (3,079 m) could result in improper and inefficient operation of the appliance, producing carbon monoxide gas in excess of safe limits, which could result in serious injury or death. Contact your gas supplier for any specific changes which may be required in your area.

GAS PIPING

	⚠ WARNING
	Fire and Explosion Hazard
	<ul style="list-style-type: none"> • Do not use water heater with any gas other than the gas shown on the rating plate. • Excessive pressure to gas control valve can cause serious injury or death • Turn off gas lines during installation. • Contact qualified installer or service agency.

Make sure the gas supplied is the same type listed on the model rating plate. The inlet gas pressure must not exceed 14 inch water column (3.5 kPa) for natural and propane gas (L.P.). The minimum inlet gas pressure shown on the rating plate is that which will permit firing at rated input.

All gas piping must comply with local codes and ordinances or with the National Fuel Gas Code (ANSI Z223.1/ NFPA-54). Copper or brass tubing and fittings (except tin lined copper tubing) should not be used.

If the gas control valve is subjected to pressures exceeding 1/2 psi (3.5 kPa), the damage to the gas control valve could result in a fire or explosion from leaking gas.

If the main gas line Shutoff serving all gas appliances is used, also turn "off" the gas at each appliance. Leave all gas appliances shut "off" until the water heater installation is complete.

A gas line of sufficient size must be run to the water heater. Consult the current edition of National Fuel Gas Code (ANSI Z223.1/NFPA 54) and your gas supplier concerning pipe size.

There must be:

- A readily accessible manual shutoff valve in the gas supply line serving the water heater, and
- A sediment trap ahead of gas control valve to help prevent dirt and foreign materials from entering the gas control valve.
- A flexible gas connector or a ground joint union between the shutoff valve and control valve to permit servicing of the unit.

Be sure to check all the gas piping for leaks before lighting the water heater. Use a soapy water solution, not a match or open flame. Rinse off soapy solution and wipe dry.

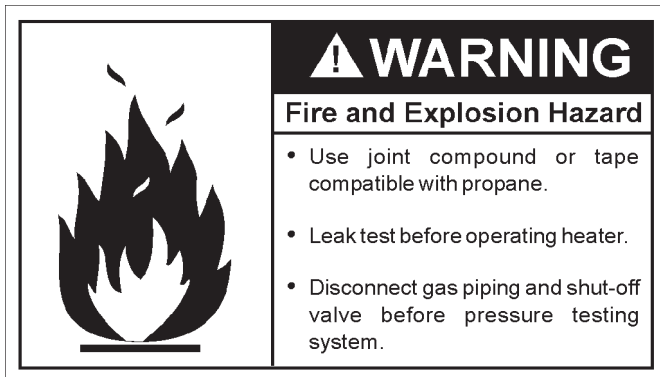

Use pipe joint compound or teflon tape marked as being resistant to the action of petroleum [Propane (L.P.)] gases.

The appliance and its gas connection must be leak tested before placing the appliance in operation.

The appliance and its individual Shutoff valve should be disconnected from the gas supply piping system during any pressure testing of that system at test pressures in excess of 1/2 pound per square inch (3.5 kPa). It should be isolated from the gas supply piping system by closing its individual manual Shutoff valve during any pressure testing of the gas supply piping system at test pressures equal to or less than 1/2 pound per square inch (3.5 kPa).

Connecting gas piping to the gas control valve of water heater can be accomplished by either of two methods shown in Figures 12 and 13.

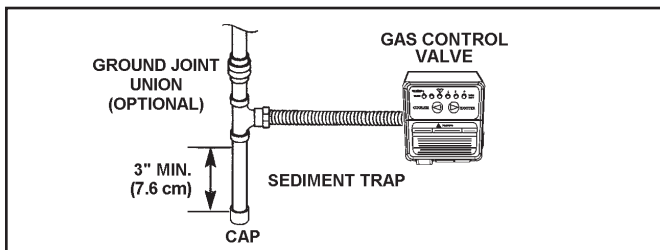

FIGURE 12. GAS PIPING WITH FLEXIBLE CONNECTOR.

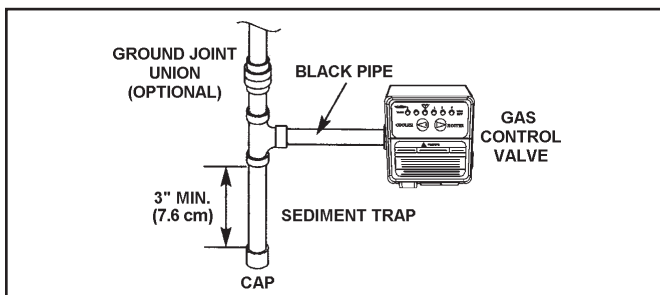
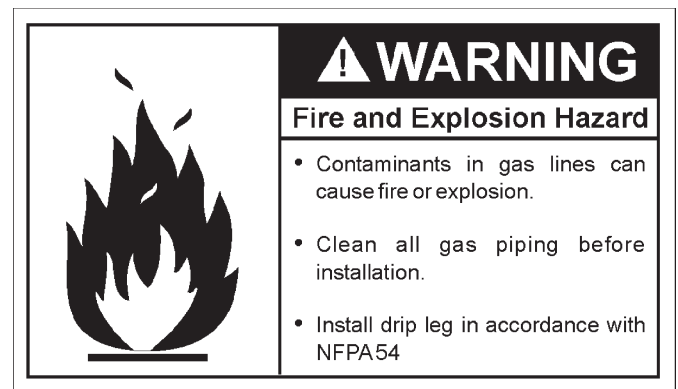

FIGURE 13. GAS PIPING WITH ALL BLACK IRON PIPE TO GAS CONTROL.

SEDIMENT TRAPS



A sediment trap should be installed as close to the inlet of the water heater as practical at the time of water heater installation. The sediment trap should be either a tee fitting with a capped nipple in the bottom outlet or other device recognized as an effective sediment trap. If a tee fitting is used, it should be installed in conformance with one of the methods of installation shown in Figures 12 and 13.

Contaminants in the gas lines may cause improper operation of the gas control valve that may result in fire or explosion. Before attaching the gas line be sure that all gas pipe is clean on the inside. To trap any dirt or foreign material in the gas supply line, a sediment trap must be incorporated in the piping. The sediment trap must be readily accessible. Install in accordance with the "Gas Piping" section. Refer to the current edition of the National Fuel Gas Code (ANSI Z223.1/NFPA 54).

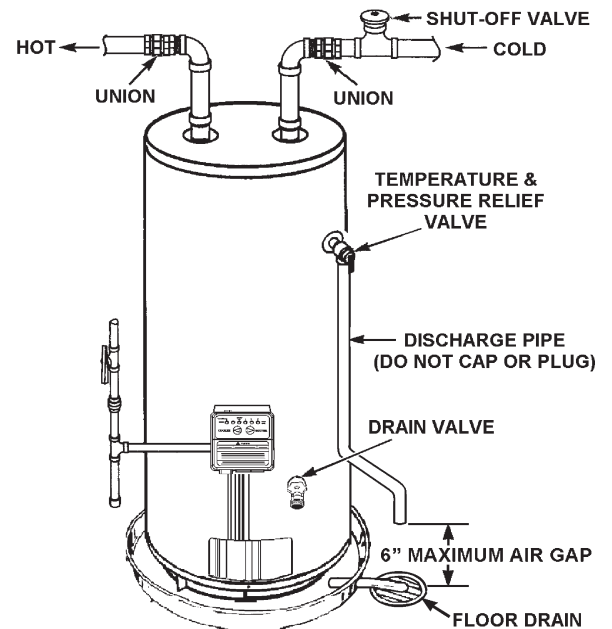

FIGURE 14.

FILLING THE WATER HEATER



Never use this water heater unless it is completely full of water. To prevent damage to the tank, the tank must be filled with water. Water must flow from the hot water faucet before turning "ON" gas to the water heater.

To fill the water heater with water:

1. Close the water heater drain valve by turning handle to the right (clockwise). The drain valve is on the lower front of water heater.
2. Open the cold water supply valve to the water heater.
NOTE: The cold water supply valve must be left open when the water heater is in use.
3. To insure complete filling of the tank, allow air to exit by opening nearest hot water faucet. Allow water to run until a constant flow is obtained. This will let air out of the water heater and the piping.
4. Check all water piping and connections for leaks. Repair as needed.

VENT PIPE ASSEMBLY

There are three parts of the vent pipe assembly that connect the water heater exhaust (located on lower back side of water heater) to inlet of the blower assembly (mounted on top of water heater) as shown in Figure 1. These parts will need to be assembled according to the instructions in the VENT PIPE PREPARATION section of this manual. These PVC parts should be assembled with ASTM D-2564 grade cement.

Assemble Vent Pipe Assemblies #1, #2 and #3 (See Figure 1) prior to cementing. The preferred orientation of Vent Pipe Assembly #1 (Condensate U-Assembly) is shown in Figure 16. However this assembly may be rotated to a different orientation as needed for the specific installation requirements. Note the rotational orientation of each part by marking a line several inches long across the joints. The long tube of Vent Pipe Assembly #2 should be approximately vertical. If it is found that either of the two pieces of pipe in Vent Pipe Assembly #2 are too long for proper fit-up, then remove as little material as possible to improve the fit-up. Keep in mind that the pipes will insert slightly further into the elbows when cement is applied as it acts as a lubricating agent. The vertical distance from the bottom of the Condensate U-Assembly to the floor that supports the water heater should be approximately 0.25" (0.64 cm),

see Figure 16. Disassemble the parts and cement back together using the alignment marks. After the cement dries, attach the assembly to the blower and the water heater exhaust using the supplied rubber boots and hose clamps.

A condensate trap is incorporated in the bottom of this vent pipe assembly. See the CONDENSATE section of this manual for further details.

VENTING

⚠ WARNING

Breathing Hazard - Carbon Monoxide Gas

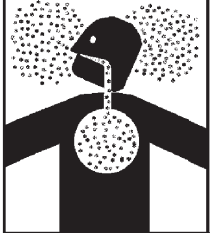

- Install vent system in accordance with codes.
- Do not operate water heater if flood damaged.
- High altitude models should be installed at elevations above 5,300 feet (1,615 m). For operation above 10,100 feet (3,079 m), a high altitude orifice must be installed.
- Do not operate if soot buildup.
- Do not obstruct water heater air intake with insulating jacket.
- Do not place chemical vapor emitting products near water heater.
- Gas and carbon monoxide detectors are available.
- Never operate the heater unless it is vented to the outdoors and has adequate air supply to avoid risks of improper operation, fire, explosion or asphyxiation.
- Analyze the entire vent system to make sure that condensate will not become trapped in a section of vent pipe and therefore reduce the open cross sectional area of the vent.

Breathing carbon monoxide can cause brain damage or death.
Always read and understand instruction manual.

TERMINATION CLEARANCES SIDEWALL POWER VENT

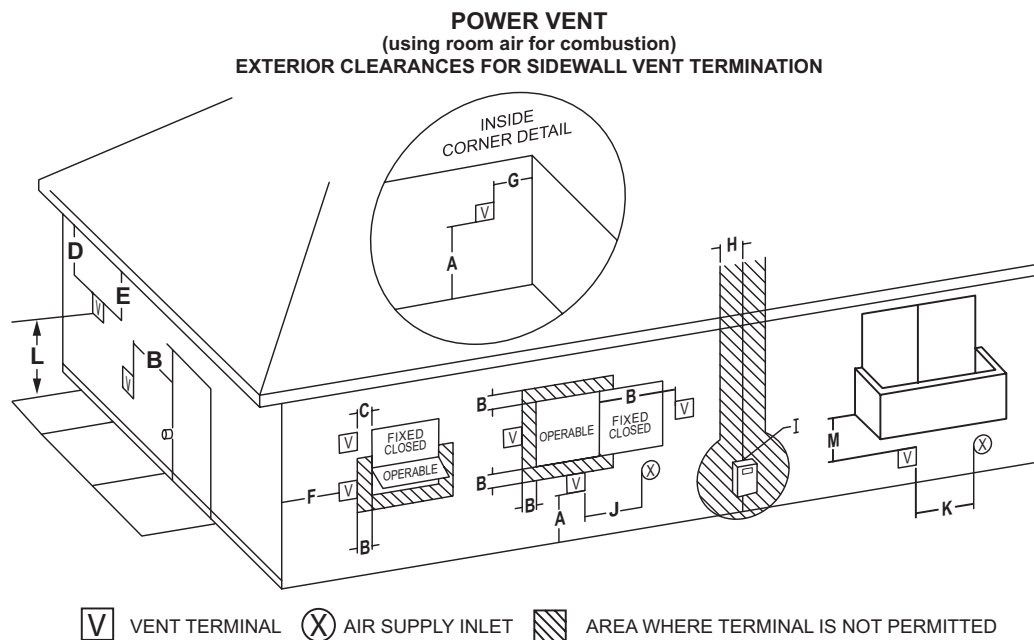

FIGURE 15.

Vent terminal clearances for “Power Vent” installations. Power Vent configurations use room air for combustion.

US INSTALLATIONS		US INSTALLATIONS			
A	Clearance above grade, veranda, porch, deck or balcony	12 inches (30 cm)	H	Clearance to each side of center line extended above meter/regulator assembly	3 feet (91 cm) within a height 15 feet (4.5 m) above the meter/regulator assembly*
B	Clearance to window or door that may be opened	4 feet (1.2 m) below or to side of opening; 1 foot (30 cm) above opening	I	Clearance to service regulator vent outlet	3 feet (91 cm)*
C	Clearance to permanently closed window	12 inches (30 cm)*	J	Clearance to a non mechanical air supply inlet into building or combustion air inlet to any other appliance	4 feet (1.2 m) below or to side of opening; 1 foot (30 cm) above opening.
D	Vertical clearance to ventilated soffit located above the terminal within a horizontal distance of 2 feet (61 cm) from the center line of the terminal	12 inches (30 cm)*	K	Clearance to a mechanical air supply inlet	3 feet (91 cm) above if within 10 feet (3 m) horizontally
E	Clearance to unventilated soffit	12 inches (30 cm)*	L	Clearance above paved sidewalk or paved driveway located on public property	7 feet (2.13 m) †
F	Clearance to outside corner	2 feet (60 cm)*	M	Clearance under veranda, porch, deck, or balcony	12 inches (30 cm) ‡
G	Clearance to inside corner	18 inches (45 cm)*			

In accordance with the current ANSI Z223.1/NFPA 54, National Fuel Gas Code.

† A vent shall not terminate directly above a sidewalk or paved driveway that is located between two single family dwellings and serves both dwellings.

‡ Permitted only if veranda, porch, deck, or balcony is fully open on a minimum of two sides beneath the floor.

* Clearance in accordance with local installation codes and the requirements of the gas supplier and the manufacturer’s installation instructions.

VENT PIPE TERMINATION

The first step is to determine where the vent pipe will terminate. See Figures 15, 20 and 21. The vent may terminate through a sidewall as shown in Figure 20 or through the roof as shown in Figure 21.

The vent system must terminate so that proper clearances are maintained as cited in local codes or the current edition of the National Fuel Gas Code, (ANSI Z223.1, 12.9.1 through 12.9.4).

Instructions on proper installation through a sidewall are provided in Figure 15.

Plan the vent system layout so that proper clearances are maintained from plumbing and wiring.

Vent pipes serving power vented appliances are classified by building codes as “vent connectors”. Required clearances from combustible materials must be provided in accordance with information in this manual under LOCATING THE NEW WATER HEATER and INSTALLING THE WATER HEATER, and with the National Fuel Gas Code and local codes.

PLANNING THE VENT SYSTEM

Plan the route of the vent system from the discharge of the blower to the planned location of the vent terminal. Refer to VAA instruction on page 24 while planning the vent system.

1. Layout total vent system to use a minimum of vent pipe and elbows.
2. This water heater is capable of venting flue gases equivalent to 25' (7.6 m) of 2" pipe, 65' (19.8 m) of 3" pipe, or 128' (39.0 m) of 4" pipe as listed in Table 2.

TABLE 2.

Number of 90° Elbows	2" Maximum Pipe - ft. (m)	3" Maximum Pipe - ft. (m)	4" Maximum Pipe - ft. (m)
1	20 (6.1)	60 (18.3)	120 (36.6)
2	15 (4.6)	55 (16.8)	112 (34.1)
3	10 (3.0)	50 (15.2)	104 (31.7)
4	--	45 (13.7)	96 (29.3)
5	--	40 (12.2)	88 (26.8)
6	--	35 (10.7)	80 (24.3)

The minimum vent lengths for each of the pipe sizes is one 90° on top of the unit plus 2' (61 cm) of straight pipe and the appropriate termination.

NOTE: The equivalent feet (m) of pipe listed above are exclusive of the termination. That is, the termination, with an installed screen, is assumed to be in the system and the remainder of the system must not exceed the lengths discussed above.

3. The blower discharge adapter is made to accept only straight sections of 2" pipe. To start, a minimum of 2 inches (5.1 cm) of 2" pipe must be attached to the blower discharge, see Figure 17.

If using 2" inch vent pipe:

A minimum of 2 inches (5.1 cm) must be attached to the blower before the first elbow. After the first elbow add the additional venting required for the installation. The total system cannot exceed the lengths discussed above, where each elbow is equal to 5 feet (1.5 m) of straight pipe.

If using 3" or 4" inch vent pipe:

Two inches (5.1 cm) of pipe must be attached to blower discharge before adding a reducer to acquire desired pipe diameter. An appropriately sized 45 degree schedule 40 DWV elbow (field supplied) vent terminal must be obtained with an equivalent screen (supplied in vent kit). The total system cannot exceed equivalent pipe lengths discussed above where each elbow is equal to 5 feet (1.5 m) of straight pipe (3" vent pipe) or 8 feet (2.4 m) of straight pipe (4" vent pipe).

NOTE: This unit can be vented with PVC pipe materials (Cellular Core ASTM-F891; DWV ASTM-D2665 or CSA B181.2; Schedule 40, 80, 120 ASTM-D1785 or CSA B137.3; or SDR Series ASTM-D2241 or CSA B137.3), CPVC pipe materials (CPVC41 ASTM-D2846 or CSA B137.6; Schedule 40, 80 ASTM-F441 or CSAB137.6; or SDR Series ASTM-F442), ABS pipe materials (Schedule 40 DWV ASTM-D2661 or CSA B181.1 or Schedule 40 DWV Cellular Core ASTM-F628). Fittings, other than TERMINATION should be equivalent to PVC-DWV fittings meeting ASTM D-2665 (Use CPVC fittings, ASTM F-438 for CPVC pipe and ABS fittings, ASTM D-2661/3311 for ABS pipe). If CPVC or ABS pipe and fittings are used, then proper cement must be used for all joints, including joining pipe to Termination (PVC Material). If local codes do not allow use of PVC termination when a material other than PVC is used for venting, then an equivalent fitting of that material may be substituted if screen in PVC terminal is removed and inserted into new fitting.

PVC Materials should use ASTM D-2564 Grade Cement; CPVC Materials should use ASTM F-493 Grade Cement and ABS Materials should use ASTM D-2235 Grade Cement.

If water heater is being installed as a replacement for an existing power vented heater in pre-existing venting, a thorough inspection of existing venting system must be performed prior to any installation work. Verify that correct material as detailed above has been used, and that minimum or maximum vent lengths and terminal location as detailed in this manual have been met. Carefully inspect entire venting system for any signs

of cracks or fractures, particularly at joints between elbows and other fittings and straight runs of vent pipe. Check system for signs of sagging or other stresses in joints as a result of misalignment of any components in system. If any of these conditions are found, they must be corrected in accordance with venting instructions in this manual before completing installation and putting water heater into service.

NOTE: A. For water heaters in locations with high ambient temperatures (above 100°F) it is recommended that CPVC or ABS pipe and fittings be used. **B.** A 22.5 degree elbow (2" vent pipe) or a 45 degree elbow (3" and 4" vent pipe) with an installed screen VENT TERMINAL must be used in all cases.

4. There will be some installations where condensate will be formed in the horizontal runs of the vent system. This condensate will run into the condensate boot attached to the blower and out the fitting. The water heater is shipped with condensate hose that attaches to the fitting on the condensate boot. No other Tee or fitting is required. See Figures 17, 20 and 21.

CONDENSATE

This water heater is a condensing unit and requires a drain to be located in close proximity to allow condensate to drain safely. One hose from blower housing, two flexible hoses from blower outlet adaptor, along with another flexible hose from VAA if installed, run to barb fittings on vent pipe assembly #2. Hose is clamped by rubber clips and flexible hoses by a clamp on jacket top cover. See Figure 17. Condensate drains from the unit at the exhaust tee located at the bottom of the unit (see figure 16). Condensate from this water heater is mildly acidic. Please note that some local codes require that condensate is treated by using a pH neutralizing filter prior to disposal.

NOTE: It is important that the field supplied drain lines beyond the 1/2" adaptor of vent pipe assembly #1 should be installed continuously tilted downward toward an appropriate drain. See Figure 16. If these instructions are not followed or if condensate drain line is blocked, water will spill from condensate trap. Do not block the holes in the hex plug on top of a small tee in vent pipe assembly #1. As with every water heater installation, a drain pan should be used to prevent water damage to surrounding area. If necessary, a condensate pump with an incorporated reservoir may be used to pump water to an appropriate drain. To avoid condensate spillage, select a pump with an overflow switch.

Caution must be used to ensure that drain is free and clear of debris and will not allow backflow through the condensate drain line. Consideration must be given to avoid freezing of the condensate lines which could result in excessive build up of condensate inside the water heater. Waterproof heat tape may be required to prevent freezing of condensate lines. Please ensure that the outlet of condensate drain does not create a slippery condition which could lead to personal injury. Care should be taken to ensure there is no kink or twist in any condensate hose. If a VAA is not installed, the unused barb fitting in vent pipe assembly #2 should be plugged using one of the break-away plugs.

⚠ **WARNING**

Breathing Hazard - Carbon Monoxide Gas



- Do NOT block the holes in the hex plug of vent pipe assembly #1.
- Do NOT elevate any portion of the field supplied drain line beyond the 1/2" adaptor above the adaptor. This must be true for entire length of the drain line including the exit into an appropriate drain.
- Condensate lines must be free and clear of debris and must not allow back flow through drain line. Condensate lines must be able to flow freely to an appropriate drain.
- Do not allow condensate lines to become crimped closed.
- Analyze entire vent system to make sure that condensate will not become trapped in a section of vent pipe and therefore reduce open cross sectional area of vent.

Breathing carbon monoxide can cause brain damage or death.
Always read and understand instruction manual.

The condensate trap may be primed by filling the CONDENSATE U-ASSEMBLY with tap water while the water heater is not operating. The system is fully primed when the water level reaches the adaptor connected into the Tee. In most installations the water heater will self-prime the condensate trap during the first full heat-up cycle. If a sound of air bubbling through water (gurgling) is heard while the blower is operating after the first heat-up cycle, then turn the unit off and contact your plumber or service representative.

If these instructions are not followed, the condensate build-up will block the exhaust outlet, which will cause improper operation.

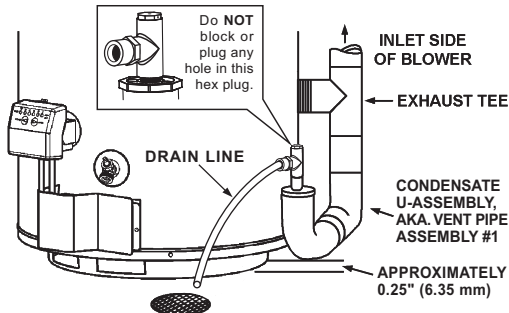

*NO PORTION OF THE FIELD SUPPLIED DRAIN LINE BEYOND THE 1/2" ADAPTOR MAY BE ELEVATED HIGHER THAN THE ADAPTOR. THIS MUST BE TRUE FOR THE ENTIRE LENGTH OF DRAIN LINE INCLUDING EXIT INTO AN APPROPRIATE DRAIN.

FIGURE 16.

Condensate is likely to form in the venting system attached to this water heater. The vent pipe should be sloped downward away from the blower assembly (not less than 1/8" (3.2 mm) nor greater than 1/2" (12.7 mm) per foot (30 cm) maximum). If the vent piping is vented level or sloped upwards away from the blower assembly, then adequate means for draining and disposing of the condensate needs to be made by the installer. Two 3/8" condensate hoses should be connected to the built in drain ports of blower outlet adaptor. If a VAA is installed, a 3/8" condensate hose should be connected to the barb fitting on it; otherwise the unused barb fitting on vent pipe assembly #2 should be plugged with one of the break-away plugs. See Figure 17.

Condensate neutralizer kits are available. Contact your distributor or Service Agency.

BLOWER ASSEMBLY INSTALLATION

1. This power vented water heater comes with blower assembly installed.
2. After unit is set in place, make sure blower assembly is still mounted securely. Make sure there is no damage to blower.
3. Condensate drains from three locations on blower assembly. See Figure 17. One flexible hose runs from bottom of blower housing; two run from the ports of rubber connector at the outlet of blower. All these three condensate hoses are connected to barb fittings at vent pipe assembly #2. The hose from bottom of blower housing is clamped by two clamps and the two hoses from rubber connector are harnessed by another clamp. Make sure there is no kink or twist.

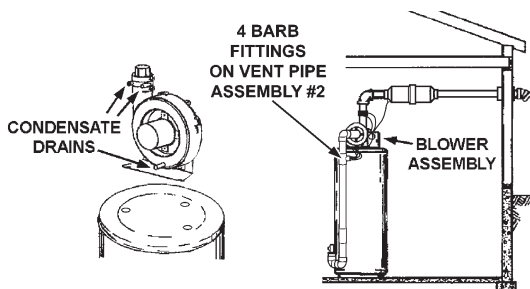

FIGURE 17.

4. Make sure there is no packing material in the inlet or discharge of the blower.
5. Make sure that the plastic tubing is still attached from the air pressure switch to the port on the blower housing. Make sure the plastic tubing is not folded anywhere between the pressure switch and the blower housing.

6. Make sure the ON/OFF switch is in the OFF position and that the outer harness is connected from the blower control box to the connector on the bottom side of the gas valve.
7. If the outer harness is not factory installed, make sure the ON/OFF switch is in the OFF position and then connect the outer harness from the blower control box to the connector on the bottom side of the gas valve.

⚠ WARNING

- Before servicing the water heater, make sure the blower assembly is unplugged and the electrical supply to the water heater is turned "OFF".
- Label all wires prior to disconnection when servicing controls. Wiring error can cause improper and dangerous operation. Verify proper operation after servicing.
- Failure to do this could result in death, serious bodily injury, or property damage.

8. Do not plug in power cord until vent system is completely installed. The Power Vent operates on 110-120 Vac. therefore a grounded outlet must be within reach of the 6 foot (1.8 m) flexible power cord supplied with the vent (See Figure 1). The power cord supplied may be used on a unit only where local codes permit. If local codes do not permit use of flexible power supply cord:

- A. Make sure the unit is unplugged from the wall outlet. Remove the plastic top cap. Remove screws and open panel on the front of the control box on the blower.
- B. Cut the flexible power cord, leaving enough to be able to make connections. Remove the strain relief fitting from the box.
- C. Install a suitable conduit fitting inside the enclosure.
- D. Splice field wiring into existing wiring using code authorized method (wire nuts, etc).
- E. Be certain that neutral and line connections are not reversed when making these connections.
- F. Ground heater properly. This water heater must be grounded in accordance with the National Electrical Code NFPA 70 and/or local codes. These must be followed in all cases.

The water heater must be connected to a grounded metal, permanent wiring system; or an equipment grounding conductor must be run with the circuit conductors and connected to the equipment grounding terminal or lead on the water heater, see Figure 19.

- G. Close the panel on the control box. Make sure that the access panel is secured shut.

9. The blower discharge boot is made to accept only straight sections of 2" pipe. To start off with an elbow, a short section of the furnished pipe, a minimum of 2 inches (5.1 cm), must be cut and glued into the end of the elbow that will mount on the discharge boot.

INSTALLATION OF VENT SYSTEM

Before beginning installation of piping system thoroughly read the section of this manual VENT PIPE PREPARATION.

If you are installing your system so that it vents through roof, please refer to section titled INSTALLATION OF VERTICAL VENT SYSTEM.

VENT TERMINAL INSTALLATION, SIDEWALL

1. Install the vent terminal by using the cover plate as a template to mark the hole for the vent pipe to pass through the wall. BEWARE OF CONCEALED WIRING AND PIPING INSIDE THE WALL.
2. If the Vent Terminal is being installed on outside of a finished wall, it

may be easier to mark both the inside and outside wall. Align holes by drilling a hole through center of the template from the inside through to the outside. The template can now be positioned on the outside wall using the drilled hole as a centering point for the template.

3. A) MASONRY SIDE WALLS

Chisel an opening approximately one half inch (1.3 cm) larger than the marked circle.

B) WOODEN SIDE WALLS

Drill a pilot hole approximately one quarter inch (0.64 cm) outside of the marked circle. This pilot hole is used as a starting point for a saws-all or sabre saw blade. Cut around the marked circle staying approximately one quarter inch (0.64 cm) outside of the line. (This will allow the vent to easily slide through the opening. The resulting gap will be covered up by the Vent Terminal cover plate.) Repeat this step on inside wall if necessary.

bead of caulking (not supplied) around the gap between the pipe and cover plate. Apply enough to fill some of the gap between the pipe and wall. Place some of the caulking on the back of the plate to hold it against the wall after installation. If the vent pipe is installed up to the wall, with a coupling on the end against the wall opening, the pipe with the vent terminal can be prepared for gluing before inserting through the wall. Slide the pipe through the wall and insert into the coupling on the other side of the wall, making sure that the vent terminal ends up pointed in the correct position, see Figure 18.

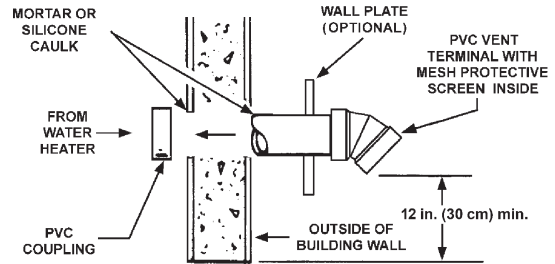

VENT TERMINATION - FIGURE 18.

SEQUENCE OF INSTALLATIONS, FIGURE 18

Cut a length of PVC pipe about 3.5 inches (8.9 cm) longer than wall thickness at the opening. Glue vent terminal to this section of pipe. Slide the wall plate over the pipe to stop against the vent terminal. Place a

CAUTION

LABEL ALL WIRES PRIOR TO DISCONNECTION WHEN SERVICING CONTROLS. WIRING ERRORS CAN CAUSE IMPROPER AND DANGEROUS OPERATION. VERIFY PROPER OPERATION AFTER SERVICING.

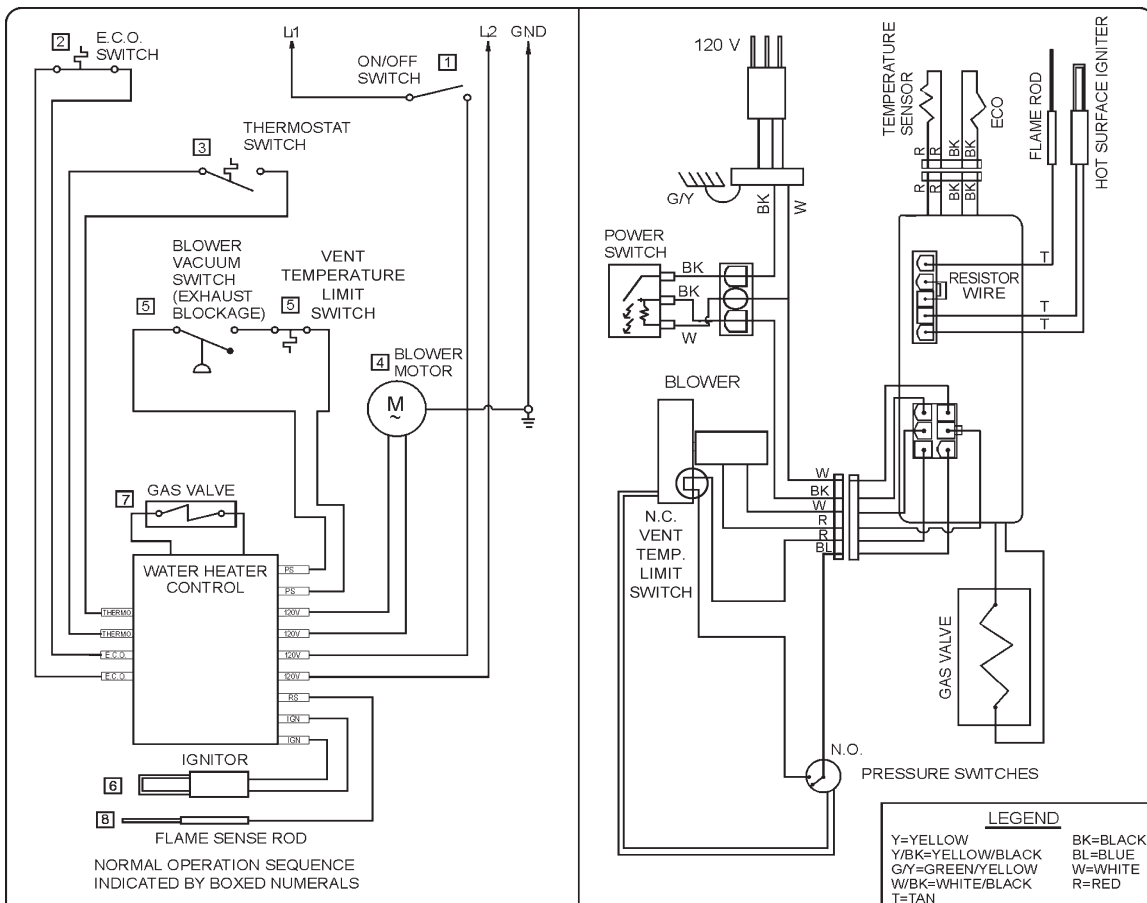

WARNING

DISCONNECT FROM ELECTRICAL SUPPLY BEFORE SERVICING UNIT. REPLACE ALL DOORS AND PANELS BEFORE OPERATING HEATER.

IF ANY OF THE ORIGINAL WIRES SUPPLIED WITH THE APPLIANCE MUST BE REPLACED, IT MUST BE REPLACED WITH APPLIANCE WIRE MATERIAL WITH MINIMUM TEMPERATURE RATING OF 105°C AND A MINIMUM SIZE OF NO. 18 AWG.

POWER VENT WIRING SCHEMATIC - FIGURE 19.

INSTALLATION OF VENT SYSTEM, SIDEWALL

With the route of the venting system and selection of materials completed, as discussed in the section of this manual titled PLANNING THE VENT SYSTEM, the through the wall vent terminal in place and the first section of piping, up to first elbow, installed at the blower it is time to complete the installation of the venting system for the sidewall installation.

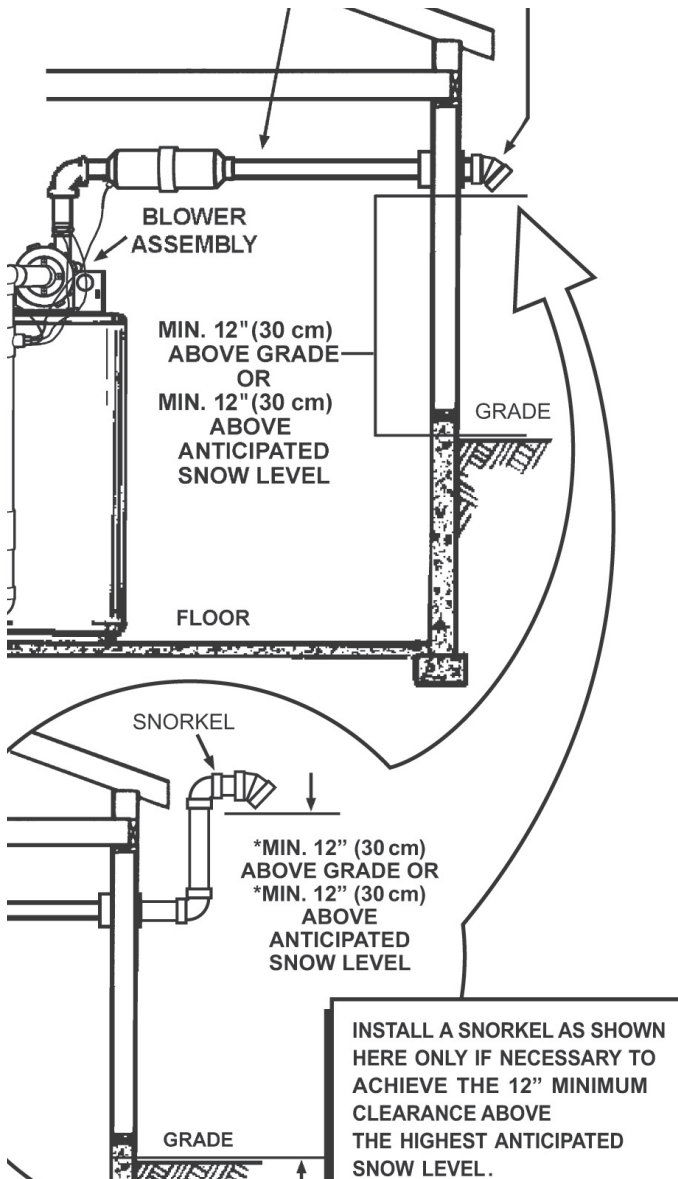

FIGURE 20

It is recommended that the completion of the venting system start at the blower assembly and run to the coupling on the inside wall of the vent terminal, Figure 18.

The vent system piping should be supported every 5 feet (1.5 m) of vertical run and every 3 feet (91 cm) of horizontal run. Follow vent pipe manufacturer's instructions for proper joining procedures.

If necessary to achieve the 12" minimum clearance above the highest anticipated snow level, install a snorkel as shown in bottom portion of Figure 20.

NOTE: With the installation of a snorkel it is necessary to use two 90° elbows that shall be considered along with the

additional vent pipe when calculating maximum equivalent feet of venting.

INSTALLATION OF VERTICAL VENT SYSTEM

A proper flashing or "BOOT" should be used to seal the pipe where it exits the roof. The total vent system should not exceed the equivalent feet of pipe as listed in Table 2.

Provide support for all pipe protruding through the roof. All piping should be properly secured. The vent system piping should be supported every 5 feet (1.5 m) of vertical run and every 3 feet (91 cm) of horizontal run. Follow vent pipe manufacturer's instructions for proper joining procedures.

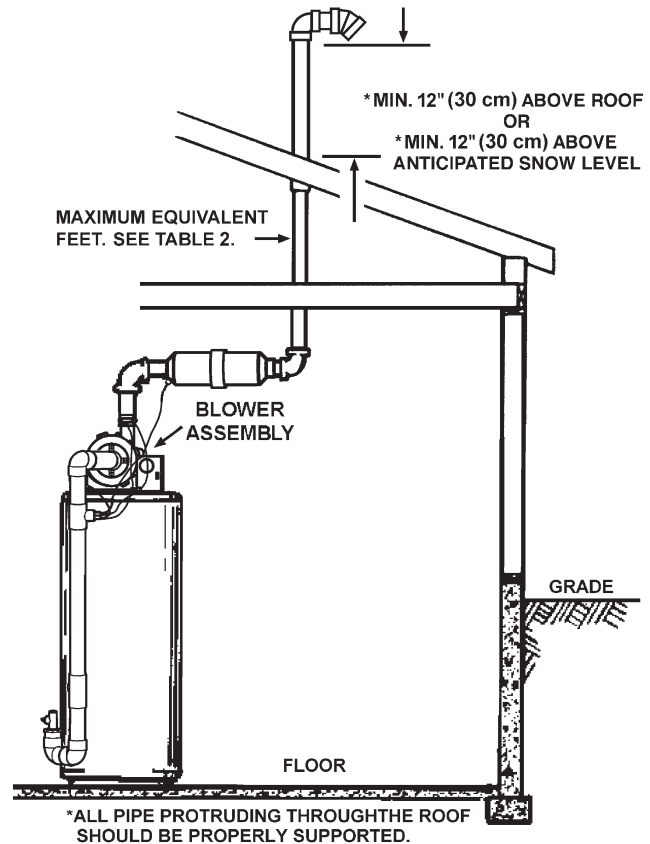

FIGURE 21

IMPORTANT

The vent system must terminate so that proper clearances are maintained as cited in local codes or the current edition of the National Fuel Gas Code (ANSI Z223.1) or the Natural Gas and Propane Installation Code (CAN/CSA-B149.1) and as listed below:

1. Vent Termination must extend a minimum of 12 inches (30 cm) above roof or 12 inches (30 cm) above the anticipated snow level to prevent blockage of the vent termination, as shown in Figures 20 and 21.

VENT ATTENUATION ASSEMBLY INSTALLATION INSTRUCTIONS

The Vent Attenuation Assembly (VAA) is designed to provide a reduction in fan noise created in the blower wheel. This installation of this VAA is optional. Review directions thoroughly prior to installing the new VAA. Please contact the manufacturer of the water heater as shown in the instruction manual with any questions or for additional product support.

VENT ATTENUATION ASSEMBLY KIT PARTS LIST

The kit consists of the following items. If a part is missing, use the contact information in the instruction manual to acquire missing component(s).

- vent attenuation assembly
- flexible tubing
- instruction sheet

VENT ATTENUATION ASSEMBLY INSTALLATION

The VAA is designed for both vertical and horizontal installations. The vertical installation and horizontal installations will require that the flexible condensate hose to be attached to the condensate hose barb located on the bottom of the VAA to release condensate. See instructions and diagrams that follow for a more detailed description.

⚠ WARNING

Breathing Hazard - Carbon Monoxide Gas



- Do NOT block the holes in the hex plug of vent pipe assembly #1.
- Do NOT elevate any portion of the field supplied drain line beyond the 1/2" adaptor above the adaptor. This must be true for entire length of the drain line including the exit into an appropriate drain.
- Condensate lines must be free and clear of debris and must not allow back flow through drain line. Condensate lines must be able to flow freely to an appropriate drain.
- Do not allow condensate lines to become crimped closed.
- Analyze entire vent system to make sure that condensate will not become trapped in a section of vent pipe and therefore reduce open cross sectional area of vent.

Breathing carbon monoxide can cause brain damage or death.
Always read and understand instruction manual.

Vertical VAA Installations (Recommended)

1. The VAA is designed to accept two inch PVC pipe into the adapters on both ends. The VAA must be installed with the condensate hose barb pointing downward. See Figure 22. The VAA has an embossed flow arrow to reflect proper orientation. For optimum performance, install VAA as close as possible to the blower assembly.
2. Use standard PVC cement (not included with kit) and glue the two inch PVC pipe coming from the blower into the VAA.
3. Perform the same sequence on the PVC pipe coming from the exhaust side (vent terminal side) of the VAA.

4. Make sure the VAA and vent pipe is supported securely to a permanent fixture (stud or wall). Use standard support straps (not supplied with kit) that may be found at a local hardware store. Failure to properly support the VAA and the surrounding vent pipe could create a hazardous situation. DO NOT puncture any surface of the VAA.
5. Locate flexible tubing. Slide one end of tubing over the hose barb located near end of the VAA. The ridges on the hose barb should prevent the tubing from sliding off, however, to ensure there are no leaks and possible dislocation from hose barb, use a wire tie or hose clamp (not supplied with kit) and secure.
6. Take the other end of the flexible tubing and slide it through the hose clamp on the jacket top cover and install it into one of the four barb fittings in vent pipe assembly #2.
7. Once installed along with the rest of the vent configuration, make sure to operate the unit through at least one heat up cycle to ensure there is no leakage around the hose barb or any joints of the VAA or vent pipe system.

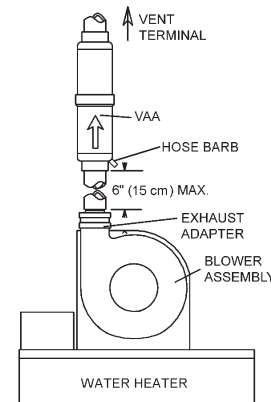

FIGURE 22: Typical Vertical Installation

Horizontal VAA Installations

1. The VAA is designed to accept two inch PVC pipe into the adapters on both ends. The VAA must be installed with the condensate hose barb pointing downward. See Figure 23. The VAA has an embossed flow arrow to reflect proper orientation. For optimum performance, install VAA as close as possible to the blower assembly.
2. Use standard PVC cement (not included with kit) and glue the two inch PVC pipe coming from the blower into the VAA.
3. Perform the same sequence on the PVC pipe coming from the exhaust side (vent terminal side) of the VAA.
4. Make sure the VAA and vent pipe is supported securely to a permanent fixture (stud or wall). Use standard support straps (not supplied with kit) that may be found at a local hardware store. Failure to properly support the VAA and the surrounding vent pipe could create a hazardous situation. DO NOT puncture any surface of the VAA.
5. Locate flexible tubing. Slide one end of tube over the hose barb located near end of the VAA. The ridges on the hose barb should prevent the tube from sliding off, however, to ensure there are no leaks and possible dislocation from hose

barb, use a wire tie or hose clamp (not supplied with kit) and secure.

- Take the other end of the flexible tubing and slide it through the hose clamp on the jacket top cover and install it into one of the four barb fittings in vent pipe assembly #2.
- Once installed along with the rest of the vent configuration, make sure to operate the unit through at least one heat up cycle to ensure there is no leakage around the hose barb or any joints of the VAA or vent pipe system.

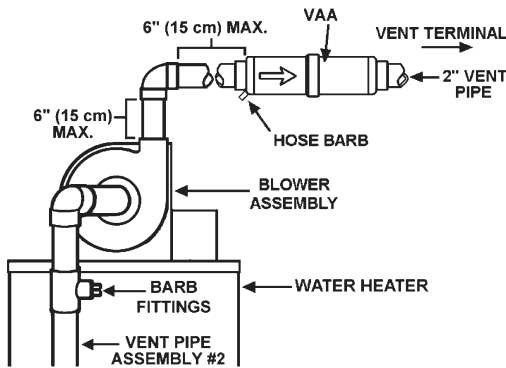

FIGURE 23: Typical Horizontal Installation

Installation for VAA with 3 & 4 inch Pipe for Vertical Vent

Some applications may require the use of 3 or 4 inch vent pipe for longer vent lengths. Please refer to Figure 24 as you review these instructions. Refer back to the vertical VAA installation steps but with the following changes to the vent construction.

3 inch vent (Vertical VAA Installations)

The VAA is designed to accommodate only 2 inch vent pipe. The installer must use 2 inch vent pipe between the blower assembly and the inlet into the VAA. On the outlet side of the VAA, a short run of 2 inch vent pipe is required. Each of the short pieces of 2 inch pipe entering and exiting the VAA must not exceed 6 inches (15 cm) in length. From this point on, a 2 inch to 3 inch adapter may be used. From the 2 inch to 3 inch adapter, the installer may use up to 65 equivalent feet (19.8 m) of pipe, see Figure 24 for typical installation.

4 inch vent (Vertical VAA Installations)

The VAA is designed to accommodate only 2 inch vent pipe. The installer must use 2 inch vent pipe between the blower assembly and the inlet into the VAA. On the outlet side of the VAA, a short run of 2 inch vent pipe is required. Each of the short pieces of 2 inch pipe entering and exiting the VAA must not exceed 6 inches (15 cm) in length. From this point on, a 2 inch to 4 inch adapter may be used. From the 2 inch to 4 inch adapter, the installer may use up to 128 equivalent feet (39.0 m) of pipe, see Figure 24 for typical installation.

Remember to operate the unit for at least one heat cycle to ensure there are no air leaks in the vent joints of the VAA and the vent pipe system. Air leaks will allow flue gas by-products to disseminate into the room creating an unsafe environment and could cause illness, asphyxiation and/or even death.

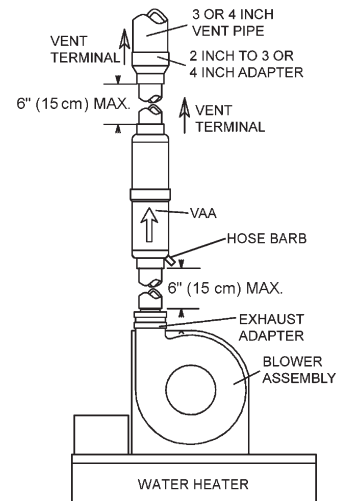

FIGURE 24: Typical Installation for Vertical Vent with 3 or 4 inch Pipe

Installation of VAA with 3 & 4 inch Pipe for Horizontal Vent

Some applications may require the use of 3 or 4 inch vent pipe for longer vent lengths. Please refer to the Figure 25 as you review these instructions. Refer back to the horizontal VAA installation steps but with the following changes to the vent construction.

3 inch vent (Horizontal VAA Installations)

The VAA is designed to accommodate only 2 inch vent pipe. The installer must use 2 inch vent pipe between blower assembly and inlet into the VAA. On the outlet side of the VAA, a short run of 2 inch vent pipe is required. From this point on, a 2 inch to 3 inch adapter may be used. From the 2 inch to 3 inch adapter, installer may use up to 52 equivalent feet (15.8 m) of pipe. This is 8 equivalent feet (2.4 m) less than the original 60 equivalent feet (18.3 m) specified with one elbow due to the 2 inch elbow instead of a 3 inch elbow required for vent from blower to the inlet of VAA, see Figure 25 for typical installation.

4 inch vent (Horizontal VAA Installations)

The VAA is designed to accommodate only 2 inch vent pipe. The installer must use 2 inch vent pipe between the blower assembly and the inlet into the VAA. On the outlet side of the VAA a short run of 2 inch vent pipe is required. From this point on, a 2 inch to 4 inch adapter may be used. From the 2 inch to 4 inch adapter, the installer may use up to 102 equivalent feet (31.1 m) of pipe. This is 18 equivalent feet (5.5 m) less than the original 120 equivalent feet (36.6 m) specified with one elbow due to the 2 inch elbow instead of a 4 inch elbow required for the vent from the blower to the inlet of the VAA, see Figure 25 for typical installation.

Remember to operate the unit for at least one heat cycle to ensure there are no air leaks in the vent joints of the VAA and the vent pipe system. Air leaks will allow flue gas by-products to disseminate into the room creating an unsafe environment and could cause illness, asphyxiation and/or even death.

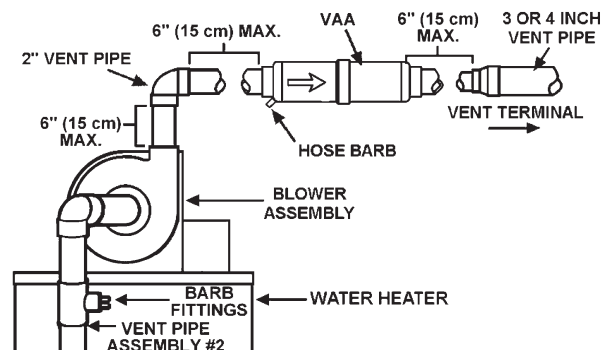

FIGURE 25: Typical Installation for Horizontal Vent with 3 or 4 inch Pipe

VENT PIPE PREPARATION

1. INITIAL PREPARATION

- A. Make sure the solvent cement you are planning to use is designed for the specific application you are attempting.
- B. Know the physical and chemical characteristics and limitations of the PVC and CPVC piping materials that you are about to use.
- C. Know the reputation of your manufacturer and their products.
- D. Know your own qualifications or those of your contractor. The solvent welding technique of joining PVC and CPVC pipe is a specialized skill just as any other pipe fitting technique.
- E. Closely supervise the installation and inspect the finished job before start-up.
- F. Contact the manufacturer, supplier, or competent consulting agency if you have any questions about the application or installation of PVC and CPVC pipe.
- G. Take the time and effort to do a professional job. Shortcuts will only cause you problems and delays in start-up. By far, the majority of failures in PVC and CPVC systems are the result of shortcuts and/or improper joining techniques.

2. SELECTION OF MATERIALS

- Cutting Device - Saw or Pipe Cutter
- Deburring Tool, Knife, File, or Beveling Machine (2" and above)
- Brush - Pure Bristle
- Rag - Cotton (Not Synthetic)
- Primer and Cleaner
- Solvent Cement - PVC for PVC Components and CPVC for CPVC Components
- Containers - Metal or Glass to hold Primer and Cement. Select the type of PVC or CPVC materials to be used on the basis of their application with respect to chemical resistance, pressure rating, temperature characteristics, etc.
- Insertion Tool - Helpful for larger diameter pipe and fittings 6 inches (15.2 cm) and above.

! WARNING

Fire or Explosion Hazard

- Do not store or use gasoline or other flammable vapors and liquids in the vicinity of this or any other appliance.
- Avoid all ignition sources if you smell LP gas.
- Do not expose water heater control to excessive gas pressure.
- Use only gas shown on rating plate.
- Maintain required clearances to combustibles.
- Keep ignition sources away from faucets after extended period of non-use.



Read instruction manual before installing, using or servicing water heater.



PRIMER

It is recommended that Tetrahydrofuran (THF) be used to prepare the surfaces of pipe and fittings for solvent welding. Do not use water, rags, gasoline or any other substitutes for cleaning PVC or CPVC surfaces. A chemical cleaner such as MEK may be used.

CEMENT

The cement should be a bodied cement of approximately 500 to 1600 centipoise viscosity containing 10-20% (by weight) virgin PVC material solvated with tetrahydrofuran (THF). Small quantities of dimethyl formamide (DMF) may be included to act as a retarding agent to extend curing time. Select the proper cement; Schedule 40 cement should be used for Schedule 40 pipe. Never use all-purpose cements, commercial glues and adhesives or ABS cement to join PVC or CPVC pipe and fittings.



! WARNING

Fire Hazard

- Primers and cements are extremely flammable, and must not be stored or used near heat or open flame.
- Also, use only in a well ventilated area.

APPLICATORS

Select a suitable pure bristle type paint brush. Use a proper width brush or roller to apply the primer and cement (see chart below). Speedy application of cement is important due to its fast drying characteristics. **IMPORTANT NOTE:** A dauber type applicator should only be used on pipe sizes 2" and below. For larger diameter pipe, a brush or roller must be used.

TABLE 3.

RECOMMENDED BRUSH* SIZE FOR PRIMER AND CEMENT APPLICATIONS	
Nominal Pipe (IPS)	Size Brush Width
2	1.5" (3.8 cm)
3	1.5" - 2.5" (3.8 cm - 6.4 cm)

***USE ONLY NATURAL BRISTLE**

3. MAKING THE JOINT

A. Cutting

Pipe must be squarely cut to allow for the proper interfacing of the pipe end and the fitting socket bottom. This can be accomplished with a miter box saw or wheel type cutter. Wheel type cutters are not generally recommended for larger diameters since they tend to flare the corner of the pipe end. If this type of cutter is used, the flare on the end must be completely removed.

NOTE: Power saws should be specifically designed to cut plastic pipe.

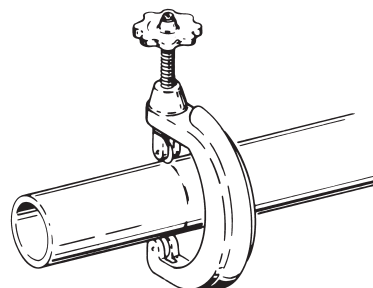

STEP A

B. Deburring

Use a knife, plastic pipe deburring tool, or file to remove burrs from the end of small diameter pipe. Be sure to remove all burrs from around the inside as well as the outside of the pipe. A slight chamfer (bevel) of about 10°-15° should be added to the end to permit easier insertion of the pipe into the end of the fitting. Failure to chamfer the edge of the pipe may remove cement from the fitting socket, causing the joint to leak.

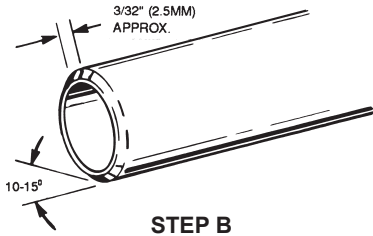

C. Test dry fit of the joint

Tapered fitting sockets are designed so that an interfaced fit should occur when the pipe is inserted about 1/3 to 2/3 of the way into the socket. Occasionally, when pipe fitting dimensions are at the tolerance extremes, it will be possible to fully insert dry pipe to the bottom of the fitting socket. When this happens, a sufficient quantity of cement must be applied to the joint to fill the gap between the pipe and fitting. The gap must be filled to obtain a strong, leak-free joint.

D. Inspection, cleaning, priming

Visually inspect the inside of the pipe and fitting sockets and remove all dirt, grease or moisture with a clean dry rag. If wiping fails to clean the surfaces, a chemical cleaner must be used. Check for possible damage such as splits or cracks and replace if necessary.

Depth-of-entry

Marking the depth of entry is a way to check if the pipe has reached the bottom of the fitting socket in Step F. Measure the fitting depth and mark this distance on the pipe O.D. You may want to add several inches to the distance and make a second mark as the primer and cement will most likely destroy your first one.

Apply primer to the surface of the pipe and fitting socket with a natural bristle brush. This process softens and prepares the PVC or CPVC for the solvent cementing step. Move quickly and without hesitation to the cementing procedure while the surfaces are still wet with primer.

E. Application of solvent cement

- Apply solvent cement evenly and quickly around outside of pipe at a width a little greater than the depth of the fitting socket.
- Apply a light coat of cement evenly around the inside of the fitting socket. Avoid puddling.
- Apply a second coat of cement to the pipe end.

	<p>⚠ WARNING</p> <ul style="list-style-type: none">• Cans of cement and primer should be closed at all times when not in use to prevent evaporation of chemicals and hardening of cement.• They are also very flammable and should be kept away from heat or flame.
---	---

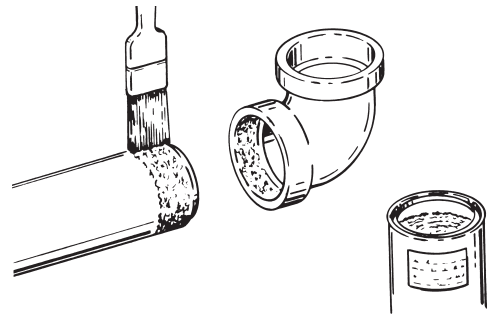

STEP E

F. Joint assembly

Working quickly, insert the pipe into the fitting socket bottom and give the pipe or fitting a 1/4 turn to evenly distribute the cement. Do not continue to rotate the pipe after it has hit the bottom of the fitting socket. A good joint will have sufficient cement to make a bead all the way around the outside of the fitting hub. The fitting will have a tendency to slide back while the cement is still wet so hold the joint together for about 15 seconds.

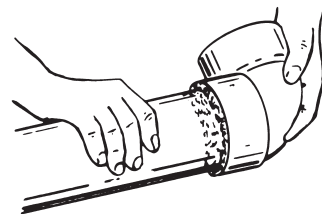

STEP F

G. Cleanup and joint movement

Remove all excess cement from around the pipe and fitting with a dry cotton rag. This must be done while the cement is still soft.

The joint should not be disturbed immediately after the cementing procedure, and sufficient time should be allowed for proper curing of the joint. Exact drying time is difficult to predict because it depends on variables such as temperature, humidity and cement integrity. For more specific information, you should contact your solvent cement manufacturer.

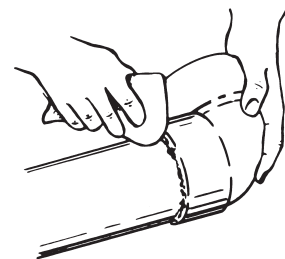

STEP G

FOR YOUR SAFETY READ BEFORE OPERATING



WARNING: If you do not follow these instructions exactly, a fire or explosion may result causing property damage, personal injury or loss of life.



BEFORE OPERATING: ENTIRE SYSTEM MUST BE FILLED WITH WATER AND AIR PURGED FROM ALL LINES.

- A. This appliance does not have a pilot. It is equipped with an ignition device which automatically lights the burner. **Do NOT try to light the burner by hand.**
- B. **BEFORE OPERATING** smell all around the appliance area for gas. Be sure to smell next to the floor because some gas is heavier than air and will settle on the floor.
- WHAT TO DO IF YOU SMELL GAS:**
- Do not try to light any appliance.
 - Do not touch any electric switch; Do not use any phone in your building.
 - Immediately call your gas supplier from a neighbor's phone. Follow the gas supplier's instructions.
- If you cannot reach your gas supplier, call the fire department.
- C. Use only your hand to push in the gas control buttons. Never use tools. If the control buttons will not push in, don't try to repair them, call a qualified service technician. Force or attempted repair may result in a fire or explosion.
- D. Do not use this appliance if any part has been under water. Immediately contact a qualified installer or service agency to replace a flooded water heater. Do not attempt to repair the unit! It must be replaced!

OPERATING INSTRUCTIONS

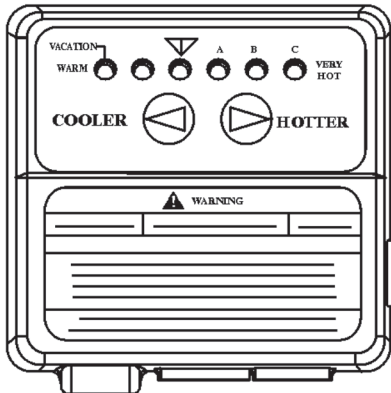

1. STOP! Read the safety information above, on this label.
2. Set the thermostat to the lowest setting by first pressing the COOLER and HOTTER buttons together and holding for 1 second. Then press the COOLER button until the WARM indicator light appears.
3. Set the "ON/OFF" switch on the blower control box to the "OFF" position.

4. This appliance is equipped with a device which automatically lights the burner. **DO NOT TRY TO LIGHT THE BURNER BY HAND.**
5. Wait five (5) minutes to clear out any gas. If you then smell gas, STOP! Follow "B" in the safety information above on this label. If you don't smell gas, go to the next step.
6. Turn on all electrical power to the appliance.
7. Set thermostat to desired setting by first pressing the COOLER and HOTTER buttons together and holding for 1 second. Then press the HOTTER button.
8. If the appliance will not operate, follow the instructions "TO TURN OFF GAS TO APPLIANCE" and call your technician or gas supplier.
9. **WATER TEMPERATURE ADJUSTMENT**
▼ is approximately 120°F.



CAUTION: Hotter water increases the risk of scald injury. Consult the instruction manual before changing temperature.



WARNING: TURN OFF ALL ELECTRIC POWER BEFORE SERVICING

TO TURN OFF GAS TO APPLIANCE

1. Set the thermostat to the lowest setting by first pressing the COOLER and HOTTER buttons together and holding for 1 second. Then press the COOLER button until the WARM indicator light appears.
2. Set the ON/OFF switch on the blower control box to the "OFF" position.
3. Turn off all electric power to the appliance if service is to be performed.

TEMPERATURE REGULATION

It is recommended that lower water temperatures be used to avoid the risk of scalding. It is further recommended, in all cases, that the water temperature be set for the lowest temperature which satisfies your hot water needs. This will also provide the most energy efficient operation of the water heater.

Short repeated heating cycles caused by small hot water uses can cause temperatures at the point of use to exceed the thermostat setting by up to 20°F (11°C). If you experience this type of use you should consider using lower temperature settings to reduce scald hazards.

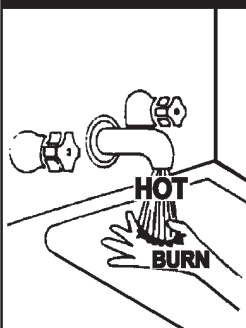

▲ DANGER Water temperature over 125°F (52°C) can cause severe burns instantly resulting in severe injury or death.

Children, the elderly, and the physically or mentally disabled are at highest risk for scald injury.

Feel water before bathing or showering.

Temperature limiting valves are available.

Read instruction manual for safe temperature setting.

HOT WATER CAN SCALD: Water heaters are intended to produce hot water. Water heated to a temperature which will satisfy space heating, clothes washing, dish washing, and other sanitizing needs can scald and permanently injure you upon contact. Some people are more likely to be permanently injured by hot water than others. These include the elderly, children, the infirm, or physically/mentally handicapped. If anyone using hot water from this heater fits into one of these groups or if there is a local code or state law requiring a certain temperature water at the hot water tap, then you must take special precautions. In addition to using the lowest possible temperature setting that satisfies your hot water needs, a means such as a mixing valve, should be used at the hot water taps used by these people or at the water heater. Mixing valves are available at plumbing supply or hardware stores, see Figure 2. Follow manufacturer's instructions for installation of the valves. Before changing the factory setting on the thermostat, in this manual, see Figure 26.

Never allow small children to use a hot water tap, or to draw their own bath water. Never leave a child or handicapped person unattended in a bathtub or shower.

The water heater should be located in an area where the general public does not have access. If a suitable area is not available, a cover should be installed over the thermostat to prevent tampering.

The water temperature setting was factory set at the lowest temperature; Pressing the "COOLER" button decreases temperature and pressing the "HOTTER" button increases the temperature.

Setting water heater temperature at 120°F (49°C) (Approx. "▼" mark on temperature setting of gas valve) will reduce risks of scalds. Some states or local codes require settings at specific lower temperatures.

To avoid any unintentional changes in water temperature settings, the control has a tamper resistant feature for changing the temperature setting. To change the temperature setting follow these instructions:

1. "Wake Up" the temperature indicators by holding down both "COOLER" and "HOTTER" temperature adjustment buttons at the same time for one second, see Figure 26. One or two of the temperature indicators will light up. These indicators will only remain on for 30 seconds if no further buttons are pressed. After 30 seconds the control will go back to "Sleep" mode.

2. Release both of the temperature adjustment buttons.
 - a. To decrease the temperature press and release the "COOLER" button until the desired setting is reached.
 - b. To increase the temperature press and release the "HOTTER" button until the desired setting is reached.

NOTE: Holding down the button will not continue to lower or raise the temperature setting. The button must be pressed and released for each temperature change desired.

Should overheating occur or the gas supply fail to shutoff, turn off the manual gas control valve to the appliance.

GAS CONTROL VALVE - FRONT VIEW

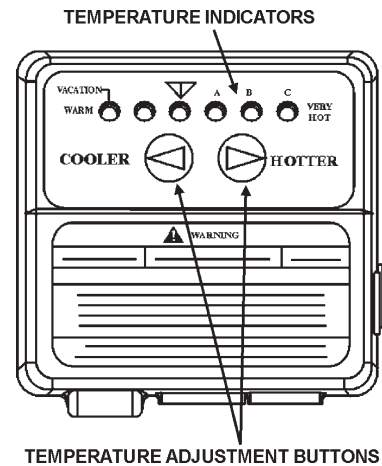

Water Temperature	Display ▼ A B C	Time to Produce 2nd & 3rd Degree Burns on Adult Skin
C-Flashing = approx. 160°F (71°C)	○○○○○●	About 1/2 second
C = approx. 150°F (66°C)	○○○○○●	About 1-1/2 seconds
B = approx. 140°F (60°C)	○○○○●○	Less than 5 seconds
A = approx. 130°F (54°C)	○○○●○○	About 30 seconds
▼ = approx. 120°F (49°C)	○○●○○○	More than 5 minutes
WARM = approx. 80°F (27°C)	●○○○○○	-----

FIGURE 26.

FOR YOUR INFORMATION

START UP CONDITIONS

SMOKE/ODOR

It is not uncommon to experience a small amount of smoke and odor during the initial start-up. This is due to burning off of oil from metal parts, and will disappear in a short while.

STRANGE SOUNDS

Possible noises due to expansion and contraction of some metal parts during periods of heat-up and cool-down do not necessarily represent harmful or dangerous conditions.

Condensation causes sizzling and popping within the burner area during heating and cooling periods and should be considered normal. See "Condensate" in this manual.

OPERATIONAL CONDITIONS

SMELLY WATER

In each water heater there is installed at least one anode rod for corrosion protection of the tank. Certain water conditions will cause a reaction between this rod and the water. The most common complaint associated with the anode rod is one of a "rotten egg smell" in the hot water. The smell is a result of four factors which must all be present for the odor to develop:

- A concentration of sulfate in the supply water.
- Little or no dissolved oxygen in the water.
- A sulfate reducing bacteria which has accumulated within the water heater (this harmless bacteria is nontoxic to humans).
- An excess of active hydrogen in the tank. This is caused by the corrosion protective action of the anode.

Smelly water may be eliminated or reduced in some water heater models by replacing the anode(s) with one of less active material, and then chlorinating the water heater tank and all water lines. Contact the local water heater supplier or service agency for further information concerning an Anode Replacement Kit and this chlorination treatment.

If the smelly water persists after the anode replacement and chlorination treatment, we can only suggest that chlorination or aeration of the water supply be considered to eliminate the water problem.

Do not remove the anode leaving the tank unprotected. By doing so, all warranty on the water heater tank is voided.

"AIR" IN HOT WATER FAUCETS

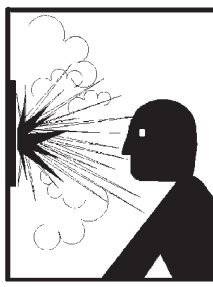

⚠ WARNING

Explosion Hazard

- Flammable hydrogen gases may be present.
- Keep all ignition sources away from faucet when turning on hot water.

HYDROGEN GAS: Hydrogen gas can be produced in a hot water system that has not been used for a long period of time (generally two weeks or more). Hydrogen gas is extremely flammable and explosive. To prevent the possibility of injury under these conditions, we recommend the hot water faucet, located farthest away, be opened for several minutes before any electrical appliances which are connected to the hot water system are used (such as a dishwasher or washing machine). If hydrogen gas is present, there will probably be an unusual sound similar to air escaping through the pipe as the hot water faucet is opened. There must be no smoking or open flame near the faucet at the time it is open.

HIGH WATER TEMPERATURE SHUTOFF SYSTEM

This water heater is equipped with an automatic reset type high limit (Energy Cutoff) sensor. The high limit switch interrupts the main burner gas flow should the water temperature reach 195°F (91°C). The high limit will automatically reset when the water temperature drops below 140°F (60°C). After cooling the tank temperature, turn off the water heater for at least 10 seconds by using the switch on top of the unit. Turn on the water heater. If this fails to correct the problem, contact your plumber or service representative.

PERIODIC MAINTENANCE

VENTING SYSTEM INSPECTION

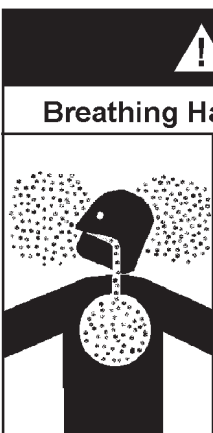

⚠ WARNING

Breathing Hazard - Carbon Monoxide Gas

- Flue gases may escape if vent pipe is not connected.
- Be alert for obstructed, sooted or deteriorated vent system to avoid serious injury or death.
- Do not store corrosive chemicals in vicinity of water heater.
- Chemical corrosion of flue and vent system can cause serious injury or death.
- Analyze the entire vent system to make sure that condensate will not become trapped in a section of vent pipe and therefore reduce the open cross sectional area of the vent.

Breathing carbon monoxide can cause brain damage or death.
Always read and understand instruction manual.

At least once a year a visual inspection should be made of the venting system. You should look for:

- Obstructions which could cause improper venting. The combustion and ventilation air flow must not be obstructed.
- Damage or deterioration which could cause improper venting or leakage of combustion products.

Be sure the vent piping is properly connected to prevent escape of dangerous flue gasses which could cause deadly asphyxiation.

Obstructions and deteriorated vent systems may present serious health risk or asphyxiation.

Chemical vapor corrosion of the flue and vent system may occur if air for combustion contains certain chemical vapors. Spray can propellants, cleaning solvents, refrigerator and air conditioner refrigerants, swimming pool chemicals, calcium and sodium chloride, waxes, bleach and process chemicals are typical compounds which are potentially corrosive.

If after inspection of the vent system you found sooting or deterioration, something is wrong. Call the local gas utility to correct the problem and clean or replace the flue and venting before resuming operation of the water heater.

BURNER OPERATION AND INSPECTION

Flood damage to a water heater may not be readily visible or immediately detectable. However, over a period of time a flooded water heater will create dangerous conditions which can cause DEATH, SERIOUS BODILY INJURY, OR PROPERTY DAMAGE. Contact a qualified installer or service agency to replace a flooded water heater. Do not attempt to repair the unit! It must be replaced!

At least once a year a visual inspection should be made of the main burner and the hot surface igniter assembly for proper flame characteristics and ignition sequences. This can be done by removing the Outer Door and viewing the main burner operation through the Viewport on the Inner Door, see Figure 1. The main burner should provide complete combustion of gas, ignite rapidly, give reasonably quiet operation, and cause no excessive flame lifting from the burner ports. If the proper flame characteristics are not evident (see Figure 27), make sure that the flow of combustion and ventilation air is not blocked.

You should also check for sooting. Soot is not normal and will impair proper combustion. A visual inspection of the main burner and HSI should also be done at least once a year, see Figure 27.

Soot build-up indicates a problem that requires correction before further use. Turn "OFF" gas to water heater and leave off until repairs are made, because failure to correct the cause of the sooting can result in a fire causing death, serious injury, or property damage.

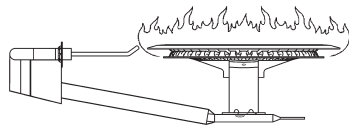

FIGURE 27.

BURNER CLEANING

In the event your burner or burner air openings require cleaning, turn the blower switch to the "OFF" position and allow the burner to cool. Call a service agency to remove and clean the burner and correct the problem that required the burner to be cleaned.

HOUSEKEEPING

Vacuum around base of water heater for dust, dirt, and lint on a regular basis.

! DANGER

Fire and Explosion Hazard

- Do not obstruct combustion air openings at the bottom of the water heater.
- Do not use or store flammable vapor products such as gasoline, solvents or adhesives in the same room or area near water heater or other appliance.
- Can cause serious injury or death.

INSTALLED IN SUITABLE AREA: To insure sufficient ventilation and combustion air supply, proper clearances from the water heater

must be maintained. See "Locating the New Water Heater" section. Combustible materials such as clothing, cleaning materials, or flammable liquids, etc. must not be placed against or adjacent to the water heater which can cause a fire.

ANODE ROD INSPECTION

CAUTION

Property Damage Hazard

- Avoid water heater damage.
- Inspection and replacement of anode rod required.

Each water heater contains at least one anode rod, which will slowly deplete (due to electrolysis) prolonging the life of the water heater by protecting the glass-lined tank from corrosion. Adverse water quality, hotter water temperatures, high hot water usage, and water softening methods can increase the rate of anode rod depletion. Once the anode rod is depleted, the tank will start to corrode, eventually developing a leak.

Certain water conditions will cause a reaction between the anode rod and the water. The most common complaint associated with the anode rod is a "rotten egg smell" produced from the presence of hydrogen sulfide gas dissolved in the water. IMPORTANT: Do not remove this rod permanently as it will void any warranties. The parts list includes a special anode rod that can be ordered if water odor or discoloration occurs. NOTE: This rod may reduce but not eliminate water odor problems. The water supply system may require special filtration equipment from a water conditioning company to successfully eliminate all water odor problems.

Artificially softened water is exceedingly corrosive because the process substitutes sodium ions for magnesium and calcium ions. The use of a water softener may decrease the life of the water heater tank.

The anode rod should be removed from the water heater tank every 3 years for inspection. NOTE: artificially softened water requires the anode rod to be inspected annually.

The following are typical (but not all) signs of a depleted anode rod:

- * The majority of the rods diameter is less than 3/8".
- * Significant sections of the support wire (approx. 1/3 or more of the anode rod's length) are visible.

If the anode rod show signs of either or both it should be replaced.

NOTE: Whether re-installing or replacing the anode rod, check for any leaks and immediately correct if found.

In replacing the anode:

1. Turn off gas supply to the water heater.
2. Shut off the water supply and open a nearby hot water faucet to depressurize the water tank.
3. Drain approximately 5 gallons of water from tank (Refer to "Draining and Flushing" for proper procedures). Close drain valve.
4. Remove old anode rod.
5. Use Teflon® tape or approved pipe sealant on threads and install new anode rod.
6. Turn on water supply and open nearby hot water faucet to purge air from water system. Check for any leaks and immediately correct any if found.

Restart the water heater as directed under "Operating Your Water Heater." See the Repair Parts Illustration for anode rod location.

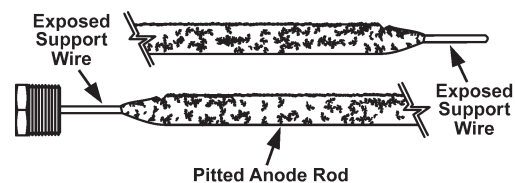
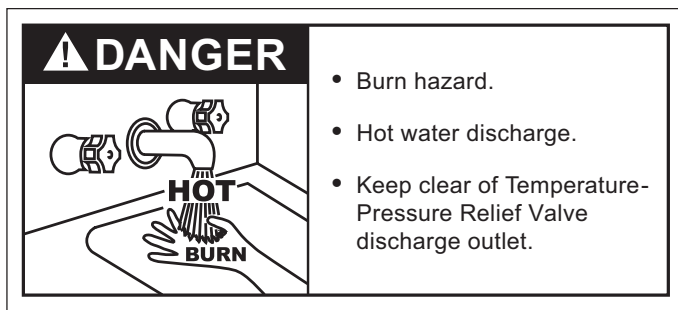

FIGURE 28. ANODE ROD DEPLETION.

TEMPERATURE-PRESSURE RELIEF VALVE TEST



It is recommended that the Temperature-Pressure Relief Valve should be checked to ensure that it is in operating condition every 6 months.

When checking the Temperature-Pressure Relief Valve operation, make sure that (1) no one is in front of or around the outlet of the Temperature-Pressure Relief Valve discharge line, and (2) that water discharge will not cause any property damage, as water may be extremely hot. Use care when operating valve as the valve may be hot.

To check the relief valve, lift lever at the end of valve several times, see Figure 28. The valve should seat properly and operate freely.

If after manually operating the valve, it fails to completely reset and continues to release water, immediately close the cold water inlet to the water heater and drain the water heater, see Draining And Flushing on page 32. Replace the Temperature-Pressure Relief Valve with a properly rated/sized new one, see Temperature-Pressure Relief Valve on page 15 for instructions on replacement.

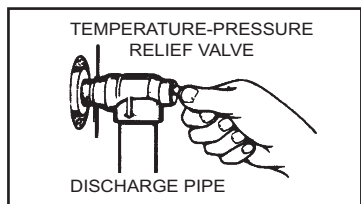

FIGURE 28.

If the Temperature-Pressure Relief Valve on the water heater weeps or discharges periodically, this may be due to thermal expansion.

Note: Excessive water pressure is the most common cause of Temperature-Pressure Relief Valve leakage. Excessive water system pressure is most often caused by "thermal expansion" in a "closed system." See Closed Water Systems and Thermal Expansion on page 14-15. The Temperature-Pressure Relief Valve is not intended for the constant relief of thermal expansion.

Temperature-Pressure Relief Valve leakage due to pressure build up in a closed system that does not have a thermal expansion tank installed is not covered under the limited warranty. Thermal expansion tanks must be installed on all closed water systems.

DO NOT PLUG THE TEMPERATURE-PRESSURE RELIEF VALVE OPENING. THIS CAN CAUSE PROPERTY DAMAGE, SERIOUS INJURY OR DEATH.

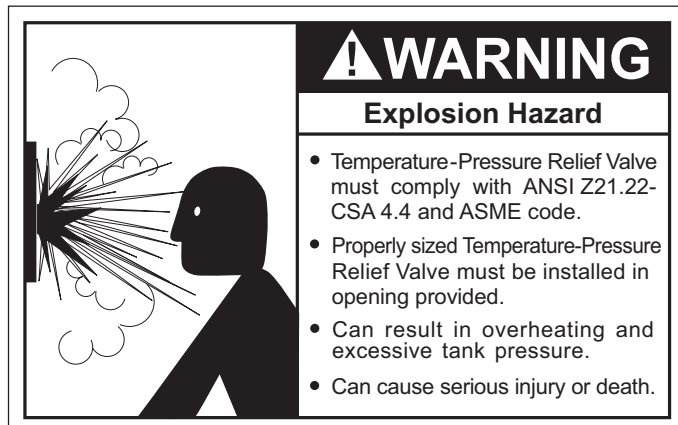

DRAINING AND FLUSHING

It is recommended that the water heater storage tank be drained and flushed every 6 months to reduce sediment buildup. The water heater should be drained if being shut down during freezing temperatures. See Typical Installation section in this manual for location of the water heater components described below.

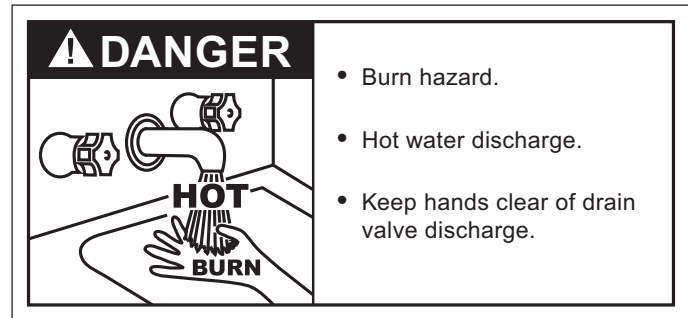

TO DRAIN THE WATER HEATER STORAGE TANK:

1. Turn off the electrical supply to the water heater.
2. Turn off the gas supply at the Main Gas Shutoff Valve if the water heater is going to be shut down for an extended period.
3. Ensure the cold water inlet valve is open.
4. Open a nearby hot water faucet and let the water run until the water is no longer hot.
5. Close the cold water inlet valve to the water heater.
6. Connect a hose to the water heater drain valve and terminate it to an adequate drain.
7. Open the water heater drain valve and allow all the water to drain from the storage tank.
8. Close the water heater drain valve when all water in the storage tank has drained.
9. Close the hot water faucet opened in Step 4.
10. If the water heater is going to be shut down for an extended period, the drain valve should be left open.

TO FLUSH THE WATER HEATER STORAGE TANK:

1. Turn off the electrical supply to the water heater.
2. Ensure the cold water inlet valve is open.
3. Open a nearby hot water faucet and let the water run until the water is no longer hot. Then close the hot water faucet.
4. Connect a hose to the drain valve and terminate it to an adequate drain.
5. Ensure the drain hose is secured before and during the entire flushing procedure. Flushing is performed with system water pressure applied to the water heater.
6. Open the water heater drain valve to flush the storage tank.
7. Flush the water heater storage tank to remove sediment and allow the water to flow until it runs clean.
8. Close the water heater drain valve when flushing is completed.
9. Remove the drain hose.
10. Fill the water heater - see Filling The Water Heater in this manual.
11. Turn on electrical supply to place water heater back in operation.
12. Allow the water heater to complete several heating cycles to ensure it is operating properly.

SERVICE

If a condition persists or you are uncertain about the operation of the water heater contact a service agency.

Use this guide to check a "Leaking" water heater. Many suspected "Leakers" are not leaking tanks. Often the source of the water can be found and corrected.

If you are not thoroughly familiar with gas codes, your water heater, and safety practices, contact your gas supplier or qualified installer to check the water heater.

Read this manual first. Then before checking the water heater make sure the gas supply has been turned "OFF", and never turn the gas "ON" before the tank is completely full of water.

LEAKAGE CHECKPOINTS

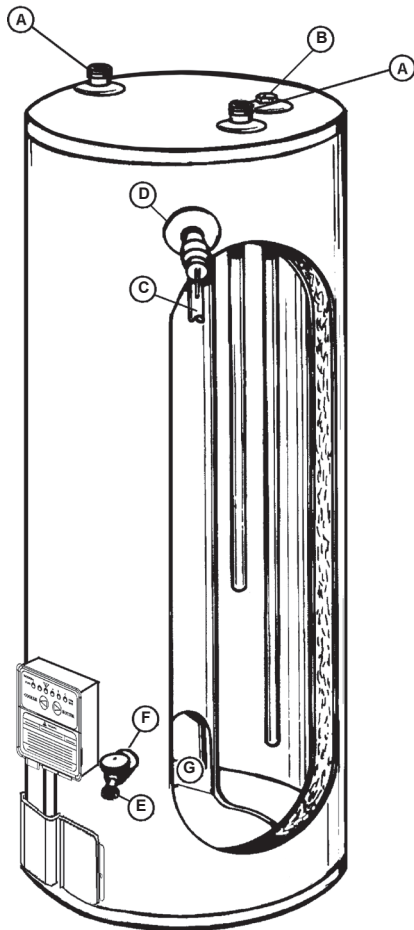

Never use this water heater unless it is completely filled with water. To prevent damage to the tank, the tank must be filled with water. Water must flow from the hot water faucet before turning "ON" gas to the water heater.

- A. *Condensation may be seen on pipes in humid weather or pipe connections may be leaking.
- B. *The anode rod fitting may be leaking.
- C. Small amounts of water from temperature-pressure relief valve may be due to thermal expansion or high water pressure in your area.
- D. *The temperature-pressure relief valve may be leaking at the tank fitting.
- E. Water from a drain valve may be due to the valve being slightly opened.
- F. *The drain valve may be leaking at the tank fitting.
- G. Combustion products contain water vapor which can condense on the cooler surfaces of the tank. Droplets form and drip onto the burner or run on the floor. This is common at the time of start-up after installation and when incoming water is cold.
- H. Water in the water heater bottom or on the floor may be from condensation, loose connections, or the relief valve. DO NOT replace the water heater until a full inspection of all possible water sources is made and necessary corrective steps taken.

Leakage from other appliances, water lines, or ground seepage should also be checked.

- * To check where threaded portion enters tank, insert cotton swab between jacket opening and fitting. If cotton is wet, follow "Draining" instructions in the "Periodic Maintenance" section and then remove fitting. Put pipe dope or teflon tape on the threads and replace. Then follow "Filling the Water Heater" instructions in the "Installing the New Water Heater" section.



⚠ WARNING

Read and understand instruction manual and safety messages before installing, operating or servicing this water heater.

Failure to follow instructions and safety messages could result in death or serious injury.

Instruction Manual must remain with water heater.

REPAIR PARTS LIST

Key No.	Part Description
1	Outer Door
2	Anode
3	Control Valve Assembly
4	Plastic Top
5	Blower Assembly
6	Switch and Harness Assembly
7	T&P Valve
8	Drain Valve
9	Wiring Harness
10	Anode Outlet
11	Vent Pipe Assembly #1
12	Vent Pipe Assembly #2
13	Vent Pipe Assembly #3
14	Inlet Tube
15	Pipe Nipple
16	Burner Tube Assembly
17	Hot Surface Igniter
18	Burner Head Assembly
19	Embossed Inner Door
20	Insulation - Inner Door
21	Insulation - Viewport
22	Window - Observation
23	Viewport
24	Nut - Serrated Hex Flange
25	Screw - Sheet Metal, # 8-15
26	Orifice - Burner
27	Vent Kit Assembly
28	Wall Plate 2"
29	Wall Plate 3"
30	Screen and Vent Terminal Assembly
31	Instruction Tag-Wire Screen F/E 3"
32	Instruction Tag-Wire Screen F/E 4"
33	Instruction Sheet
34	Wire Screen 3"
35	Wire Screen 4"
36	Wall Plate 4"
37	Flexible Tubing

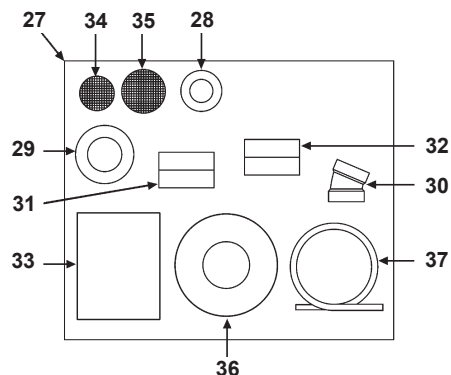
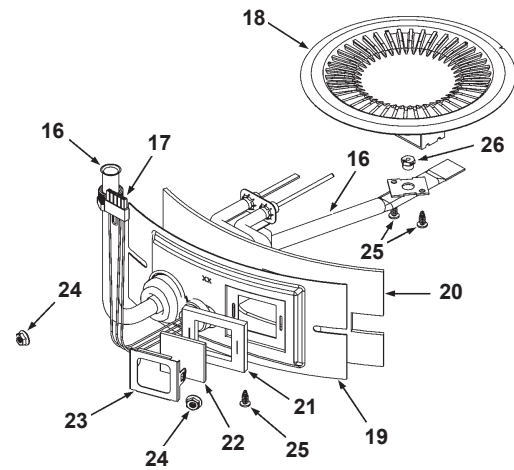
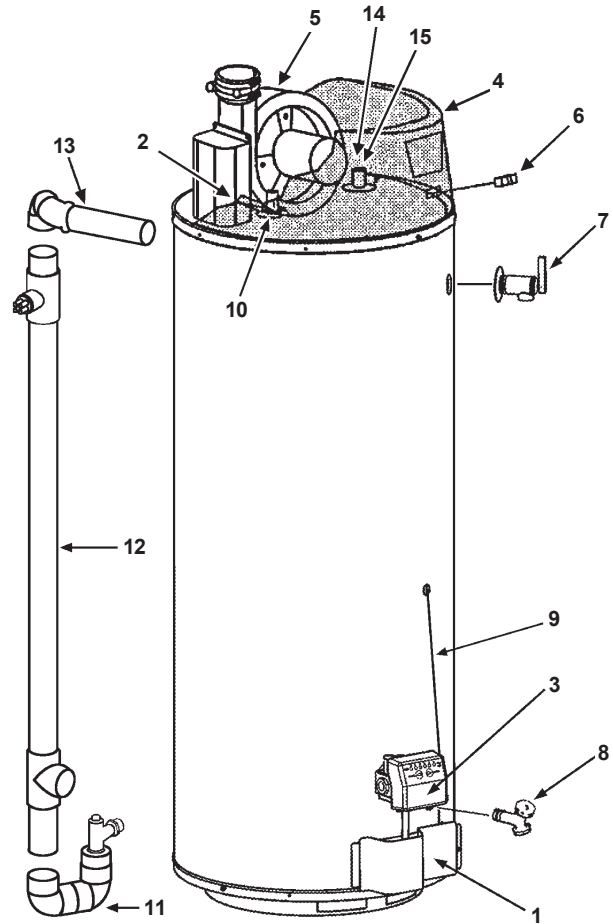

Now that you have purchased this water heater, should a need ever exist for repair parts or service, simply contact the company it was purchased from or direct from the manufacturer listed on the rating plate on the water heater.

Be sure to provide all pertinent facts when you call or visit.

Selling prices will be furnished on request or parts will be shipped at prevailing prices and you will be billed accordingly.

The model number of your Gas Water Heater will be found on the rating place located above the gas control valve.

WHEN ORDERING REPAIR PARTS, ALWAYS GIVE THE FOLLOWING INFORMATION:

- MODEL NUMBER
- TYPE GAS (NATURAL OR PROPANE (L.P.))
- SERIAL NUMBER
- PART DESCRIPTION







THIS IS A REPAIR PARTS LIST, NOT A PACKING LIST. PARTS ARE NOT DRAWN TO SCALE.

TROUBLESHOOTING GUIDELINES

TROUBLE SHOOTING

Please check guidelines below. For your safety, water heater service should be performed only by a qualified service technician. Read the GENERAL SAFETY INFORMATION section first.

INTELLI-VENT TROUBLESHOOTING CHART - USER CONTROL

#	LED STATUS	PROBLEM	SOLUTION
1		Inadequate or no earth ground.	<ol style="list-style-type: none"> 1 Ensure the wall outlet (power supply) is properly grounded. 2 Ensure all ground connections/wires on the water heater are securely connected.
2		High resistance to earth ground or reversed polarity in the 120 VAC power supply.	<ol style="list-style-type: none"> 1 Ensure that the water heater is securely connected to earth ground. 2 Ensure that the wall outlet/power supply is properly wired. Also, ensure that internal 120 VAC wiring connections and the wiring harness have no reversed wires. 120 VAC "hot" wire must connect to the on/off switch.
3		<p>Pressure switch circuit remaining closed for more than 5 seconds after heating cycle begins.</p> <p>Blower may not start in this condition.</p>	<ol style="list-style-type: none"> 1 Ensure air pressure switch circuit wiring is correct and the air pressure switch is not jumpered. 2 Replace the air pressure switch.
4		<p>Pressure switch circuit remains open longer than 5 seconds after the blower is energized.</p> <p>Blower may run continuously in this condition.</p>	<ol style="list-style-type: none"> 1 Ensure the air pressure switch sensing tube is properly connected at both ends and is not kinked or damaged. 2 Ensure the correct size of vent and intake air pipe (direct vent products) was used per the installation instructions that came with the water heater. 3 Ensure maximum number of elbows or maximum equivalent feet of vent or intake air pipe has not been exceeded per the installation instructions that came with the water heater. 4 Ensure there are no obstructions in the vent or intake air pipe.
5		Open igniter circuit.	<ol style="list-style-type: none"> 1 Check wiring to the hot surface igniter assembly - replace igniter assembly if wiring is damaged or worn. 2 Check resistance of the igniter at igniter assembly plug - should be between 11 and 18 ohms at room temperature (77° F at plug end) - replace igniter if open or shorted. 3 Check igniter assembly plug and the socket on the gas control valve/thermostat for good connection. Replace igniter assembly if the plug is worn or damaged. 5 Replace the gas control valve/thermostat if the igniter assembly socket on the bottom of the control is worn or damaged.
6		<p>Ignition/flame failure.</p> <p>The gas control valve/thermostat has reached the maximum number of retries (3) for ignition and is currently locked out for one hour.</p> <p>Cycle the power to the water heater off and on to reset.</p>	<ol style="list-style-type: none"> 1 Ensure flame sensor is making good contact with the burner flame and ensure flame is steady. Also ensure supply and manifold gas pressures are within the requirements in the installation manual. 2 Gas supply is turned off or gas pressure is too low. For low gas pressure, consult with your gas utility. 3 Ensure the flame sensor is clean - use fine steel wool to clean the flame sensor. 4 Check igniter assembly plug and the socket on the bottom of the gas control valve/thermostat for good connection. Replace igniter assembly if the plug is worn or damaged. Replace the gas control valve/thermostat if socket is worn or damaged. 5 Replace igniter assembly.

#	LED STATUS	PROBLEM	SOLUTION
7		Self diagnostic check has detected a problem with the gas valve driver circuit, internal microprocessor, or other internal circuits.	1 Turn the power off for 10-20 seconds then on again to clear these error codes. 2 If any of these error codes persist or cannot be cleared - replace the gas control valve/thermostat.
8			
9			
10		Flame signal sensed out of proper sequence.	1 Turn the power off for 10-20 seconds then on again to clear these error codes. 2 Replace the gas control valve/thermostat if this error code persists.
11		Water in the tank has exceeded the maximum allowable temperature, activating the ECO (energy cut off).	1 Turn the power off for 10-20 seconds then on again to clear these error codes. 2 Replace the gas control valve/thermostat if the error code persists.
12		One or both of the temperature adjust buttons are stuck.	1 Press and release both temperature adjust buttons several times - cycle water heater power off and on. 2 Replace the gas control valve/thermostat if the error code persists.
13		The water temperature sensor (located in the control valve's immersion probe) is either open or shorted.	1 Turn the power off for 10-20 seconds then on again to clear these error codes. 2 Replace the gas control valve/thermostat if the error code persists.
14		The FV (fl ammable vapor) sensor is either open or shorted.	1 Turn off power to the water heater. Ensure all FV sensor wiring, the ignitor assembly plug, and the ignitor assembly socket on the bottom of the Intelli-Vent control are making good contact. Repair or replace any worn/damaged components that are not making good connection.. 2 Replace the FV sensor.
15		Self diagnostic check has detected the presence of fl ammable vapors from the FV (fl ammable vapor) sensor.	1 Do not touch any electrical switch, do not use any phone in your building, and do not try to light any appliance. 2 Smell around the water heater to ensure there are no gas leaks at the gas control valve/thermostat, in the supply gas line(s), or any other type of fl ammable vapor(s) in the area. 3 Carefully inspect the area surrounding the water heater for any substances such as gasoline, paint, paint thinners, varnish, or cleaners that could emit flammable vapors. Remove anything that can potentially emit flammable vapors from the area and store it properly in a different location. 4 Call the technical information support phone number shown on the water heater labeling for further assistance.
16		Air pressure switch circuit is opening repeatedly during one heating cycle. LDO (Lint, Dust, and Oil) lockout condition.	1 On models equipped with a dilution air intake screen on the blower assembly - check/clean the screen. 2 On models equipped with a combustion air intake screen on the base ring (bottom) of the water heater - check/clean the screen. 3 Ensure intake air screen(s) on models so equipped are not obstructed.

TROUBLESHOOTING GUIDELINES

These guidelines should be utilized by a qualified service agent.

PROBLEM	CAUSE	SOLUTION
NOT ENOUGH HOT WATER	1.) Blower will not run.	
	a. "ON/OFF" control switch turned off.	Turn switch to the "ON" position.
	b. Blower unplugged.	Plug blower back into 115 VAC outlet.
	c. No power at outlet.	Repair service to outlet.
	d. Thermostat defective.	Replace thermostat.
	e. Control harness defective.	Replace control harness.
	f. High limit control circuit open.	Reduce water temperature below 140°F (60°C). Turn the power switch to the off position. Wait 10 seconds. Turn the power switch to the on position. Reduce the temperature set point to minimize likelihood of reoccurrence. If this does not solve the problem, replace thermostat.
	g. Blower motor defective.	Replace blower assembly.
	2.) Thermostat problems	
	a. Thermostat set too low.	Adjust temperature control higher.
	b. Thermostat or ECO defective.	Replace thermostat.
	3.) Others	
	a. Heater undersized.	Reduce hot water use.
b. Low gas pressure.	Contact dealer.	
c. Incoming water is usually cold.	Allow more time for heater to reheat.	
d. Leaking hot water pipes or fixtures.	Have plumber check and repair leaks.	
e. Heater not lit or thermostat not on.	Refer to LIGHTING INSTRUCTIONS.	
VENT PIPE TOO HOT (ABOVE 170° F [77° C])	Wrong burner orifice.	Install correct orifice.
YELLOW FLAME	Dirt in burner ports.	Turn off heater and gas, clean burner head.
	Combustion air path restricted.	Check exhaust venting and air openings in bottom base pan for obstructions or blockage.
CONDENSATION	Water on the floor under heater.	See CONDENSATION section.
	Water dripping from blower assembly.	Check the hose connections at blower and vent pipe assembly #2.
WATER LEAKS	Improperly sealed, hot or cold supply connections, relief valve, drain valve or thermostat threads.	Check for leaks at all condensate points. See Figure 1. Also see LEAK CHECKPOINTS section.
	Leakage from other appliances or water lines.	Inspect other appliances near water heater.
	Condensation of flue products.	Refer to CONDENSATION section.
LEAKING T & P	Thermal expansion in closed water system.	Install thermal expansion tank (Do not plug T&P valve).
	Improperly sealed valve.	Check relief valve for proper operation (Do not plug T&P valve).
HOT WATER ODORS (refer to Smelly Water)	High sulfate or mineral content in water supply.	Drain and flush heater thoroughly then refill.
	Bacteria in water supply.	Chlorinate water supply.
WATER TOO HOT	Thermostat set too high.	Refer to TEMPERATURE REGULATION section.
WATER HEATER SOUNDS	Condensation dripping on burner.	Refer to CONDENSATION section
SIZZLING - RUMBLING	Sediment at bottom of heater tank.	Clean sediment from tank. Refer to DRAINING.
SOOTING	Improper combustion.	Refer to Combustion Air and Ventilation
BURNER WILL NOT STAY LIT – GOES OUT 4-5 SECONDS	Outlet polarity is reversed.	Test polarity and correct.
	High ambient room temperature.	Contact a service agency to determine cause.
	Combustion air path restricted.	Check exhaust venting and air openings in bottom base pan for obstructions or blockage.
	Defective gas valve.	Replace gas valve.
VENT GAS ODORS	Lack of air supply.	Shut off water heater immediately and contact a service agency to determine cause.
	Improperly installed vent piping.	
	Downdraft	
	Poor Combustion	

NOTES

LIMITED RESIDENTIAL GAS WARRANTY

THIS WARRANTY IS APPLICABLE TO THE ORIGINAL OWNER ONLY. If the glass lined tank in this water heater shall prove upon examination by (the warrantor) to have leaked during the warranty period in normal residential use, due to natural corrosion from potable water therein, the warrantor will furnish the ORIGINAL OWNER a replacement water heater of equivalent size and current model, or a replacement part for any component part which fails in normal use, in accordance with the warranty terms and conditions specified below. THE WATER HEATER REPLACEMENT MODEL OR PART WILL BE WARRANTED FOR ONLY THE UNEXPIRED PORTION OF THE ORIGINAL WARRANTY. The warranty period will be determined by the original installation date of the water heater. PROOF-OF-PURCHASE AND PROOF-OF-INSTALLATION ARE NECESSARY TO VALIDATE THIS WARRANTY. This warranty is not transferable.

WARRANTY PERIOD		
Product Line	TANK ¹	PARTS ²
GP6 50YTVIT	6 YEARS	6 YEARS

When the water heater has been used for other than single family residential application: 1. The Tank warranty shall be reduced to 3 years on 10 year models and 1 year on 6 and 8 year models. 2. The parts warranty shall be reduced to 1 year for all models. Returned parts which meet any of the following conditions are not covered by this warranty: 1) improper installation or removal; 2) damaged by other than normal wear; 3) replaced for cosmetic purposes; or 4) returned with defaced date codes.

CONDITIONS AND EXCEPTIONS

This warranty shall apply only when the water heater is installed and operated in accordance with: 1) all local fire codes and plumbing codes, ordinances and regulations; 2) the printed instructions provided with it; 3) good industry practices; and 4) proper safety practices such as but not limited to a properly sized drain pan if installed in an area where leakage from connections of the tank would result in damage to the area adjacent to the heater. In addition, a new temperature and pressure relief valve, certified by the Canadian Standards Association must have been properly installed and piped to the nearest drain.

This warranty shall apply only when the heater is:

- owned by the original purchaser;
- used at temperatures not exceeding the maximum calibrated setting of its thermostat;
- not subjected to excessive water pressure fluctuations and not subject to an operating pressure greater than 150 P.S.I.;
- filled with potable water, free to circulate at all times and with the tank free of damaging water sediment or scale deposits;
- used in a non-corrosive and non-contaminated atmosphere;
- used with factory approved anode(s) installed;
- in its original installation location;
- in the United States and its territories or possessions or Canada;
- sized in accordance with proper sizing techniques for residential water heaters;
- bearing a rating plate which has not been altered, defaced or removed except as required by the warrantor;
- used in an open system or in a closed system with a properly sized and installed thermal expansion tank;
- fired at the factory rated input using the fuel stated in the face of the rating plate;
- operated with the inner and outer combustion chamber doors in place;
- maintained in accordance with the instructions printed in the manual included with the heater.

Any accident to the water heater or any part thereof (including freezing, fire, floods, or lightning), any misuse, abuse or alteration of it, any operation of it in a modified form, or any attempt to repair tank leaks or parts, will void this warranty.

SERVICE AND LABOR RESPONSIBILITY

UNDER THIS LIMITED WARRANTY, THE WARRANTOR WILL PROVIDE ONLY A REPLACEMENT WATER HEATER OR PART THEREOF. THE OWNER IS RESPONSIBLE FOR ALL OTHER COSTS. Such costs may include but are not limited to:

- Labor charges for service, removal, or reinstallation of the water heater or part thereof.

- Shipping and delivery charges for forwarding the new water heater or replacement part from the nearest distributor and returning the claimed defective heater or part to such distributor except in the state of California where such charges are the manufacturer's responsibility.
- All cost necessary or incidental for handling and administrative charges, and for any materials and/or permits required for installation of the replacement heater or part.

LIMITATION ON IMPLIED WARRANTIES

Implied warranties, including any warranty of merchantability imposed on the sale of this heater under state law are limited to one year duration for the heater or any of its parts. Some states do not allow limitations on how long an implied warranty lasts, so the above limitations may not apply to you.

CLAIM PROCEDURE

Any claim under this warranty should be initiated with the dealer who sold the heater, or with any other dealer handling the warrantor's products.

The warrantor will only honor replacement with identical or similar water heater or parts thereof which are manufactured or distributed by the warrantor.

Dealer replacements are made subject to in-warranty validation by warrantor.

PROOF-OF-PURCHASE AND PROOF-OF-INSTALLATION DATES ARE REQUIRED TO SUPPORT WARRANTY FOR CLAIM FROM ORIGINAL OWNER. THIS FORM DOES NOT CONSTITUTE PROOF-OF-PURCHASE OR PROOF-OF-INSTALLATION.

DISCLAIMERS

NO EXPRESS WARRANTY HAS BEEN OR WILL BE MADE IN BEHALF OF THE WARRANTOR WITH RESPECT TO THE MERCHANTABILITY OF THE HEATER OR THE INSTALLATION, OPERATION, REPAIR OR REPLACEMENT OF THE HEATER OR PARTS. THE WARRANTOR SHALL NOT BE RESPONSIBLE FOR WATER DAMAGE, LOSS OF USE OF THE UNIT, INCONVENIENCE, LOSS OR DAMAGE TO PERSONAL PROPERTY, OR OTHER CONSEQUENTIAL DAMAGE. THE WARRANTOR SHALL NOT BE LIABLE BY VIRTUE OF THIS WARRANTY OR OTHERWISE FOR DAMAGE TO ANY PERSONS OR PROPERTY, WHETHER DIRECT OR INDIRECT, AND WHETHER ARISING IN CONTRACT OR IN TORT.

Some states do not allow the limitation or exclusion of incidental or consequential damages, so the above limitation or exclusion may not apply to you.

This warranty gives you specific legal rights, and you may also have other rights which vary from state to state. Should governmental regulations or industry standards prohibit the Manufacturer from furnishing a comparable model replacement under this warranty, the Owner will be furnished with the closest comparable water heater meeting the current governmental regulations and industry standards. A supplementary fee may be assessed to cover the additional cost associated with the changes made to meet applicable regulations and standards.

Fill out and keep with water heater.

IMPORTANT INFORMATION

Model Number _____
Serial Number _____
<u>Installation Information:</u>
Date Installed _____
Company's Name _____
Street or P.O. Box _____
City, State, and Zip Code _____
Phone Number _____ Plumber's Name _____



www.statewaterheaters.com
500 Tennessee Waltz Parkway
Ashland City, TN 37015
Technical Support 800-365-0024
Parts 800-821-2017