

ALPHA HWR

Installation and operating instructions



ALPHA HWR

English (US)

Installation and operating instructions	4
Limited consumer warranty	25

Original installation and operating instructions	12.6	Overheated boiler	21
Table of contents	12.7	Noise in the system	21
	12.8	Alarms	22
	12.9	Warnings	23
1. General information	5	13. Technical data	24
1.1 Hazard statements	5	14. Disposing of the product	24
1.2 Notes	5	15. Document quality feedback	24
2. Product introduction	6		
2.1 ALPHA HWR	6		
2.2 Intended use	6		
2.3 Pumped liquids	6		
2.4 Identification	7		
3. Approvals	8		
3.1 Approvals of pump	8		
4. Receiving the product	8		
4.1 Inspecting the product	8		
4.2 Scope of delivery	8		
5. Installation requirements	9		
5.1 Radio frequency radiation exposure information (for Canada and US only)	9		
5.2 Optimal installation and operation	9		
6. Mechanical installation	10		
6.1 Installation diagram	10		
6.2 Mounting the product	10		
6.3 Changing the control box position	11		
7. Electrical connection	12		
7.1 Wiring the pump	12		
8. Starting up the product	13		
8.1 Venting the pump	13		
8.2 Dry-running protection	13		
9. Control functions	14		
9.1 Operating panel	14		
9.2 Light fields indication	15		
9.3 Control modes	15		
10. Setting of the product	16		
10.1 Connecting the product to Grundfos GO	16		
10.2 Guided setup	17		
10.3 Air detection and system venting	17		
10.4 Flow limitation	17		
10.5 Trend data	17		
10.6 Updating the software	17		
10.7 Resetting to factory settings	17		
11. Service	18		
12. Fault finding	19		
12.1 Fault indication on the pump operating panel	20		
12.2 Overview of alarm and warning codes	20		
12.3 Resetting alarms and warnings manually with Grundfos GO	21		
12.4 Alarm and warning code logs	21		
12.5 Automatic deblocking	21		

1. General information



Read this document before you install the product. Installation and operation must comply with local regulations and accepted codes of good practice.

1.1 Hazard statements

The symbols and hazard statements below may appear in Grundfos installation and operating instructions, safety instructions and service instructions.



DANGER

Indicates a hazardous situation which, if not avoided, will result in death or serious personal injury.



WARNING

Indicates a hazardous situation which, if not avoided, could result in death or serious personal injury.



CAUTION

Indicates a hazardous situation which, if not avoided, could result in minor or moderate personal injury.

The hazard statements are structured in the following way:



SIGNAL WORD

Description of the hazard

Consequence of ignoring the warning

- Action to avoid the hazard.

1.2 Notes

The symbols and notes below may appear in Grundfos installation and operating instructions, safety instructions and service instructions.



Observe these instructions for explosion-proof products.



A blue or gray circle with a white graphical symbol indicates that an action must be taken.



A red or gray circle with a diagonal bar, possibly with a black graphical symbol, indicates that an action must not be taken or must be stopped.



If these instructions are not observed, it may result in malfunction or damage to the equipment.



Tips and advice that make the work easier.

2. Product introduction

2.1 ALPHA HWR



TM086124

ALPHA HWR is designed for domestic hot-water recirculation systems with a dedicated return line. The circulator comes with an integrated sensor that estimates temperature, eliminating the need for an aquastat. The built-in digital timer makes it possible to schedule the pump's on/off hours, helping save energy when hot water is not required in the home.

The new toolless, removable power connector results in fast and easy installation. Grundfos GO provides the ability to conveniently troubleshoot the system through the event log, run guided setup, set custom control modes and run software updates. Historical trend data for flow, head, estimated media temperature and on-cycle durations are available in the app.

2.2 Intended use

This pump is intended for domestic hot-water recirculation with a dedicated return line.

2.3 Pumped liquids

WARNING

Electric shock

Death or serious personal injury



- For indoor use only.
- This pump has not been investigated for use in swimming pool or marine areas.

WARNING

Fire or explosion hazard

Death or serious personal injury



- The pump must not be used for the transfer of flammable liquids such as diesel oil, gasoline and similar liquids.

The product is suitable for pumping clean, thin, non-aggressive and non-explosive liquids without solid particles or fibers or mineral oils.

If required, 50 % of the volume solution of glycol and water can be used. However, a decrease in pump performance may occur due to an increase in the viscosity of the solution. Contact the manufacturer for information regarding suitability of the pump for pumping other liquids.

The pump is designed to circulate water from 36 to 203 °F (2 to 95 °C) up to a maximum pressure of 175 psi (12 bar), depending on the variant.

2.4 Identification

2.4.1 Nameplate

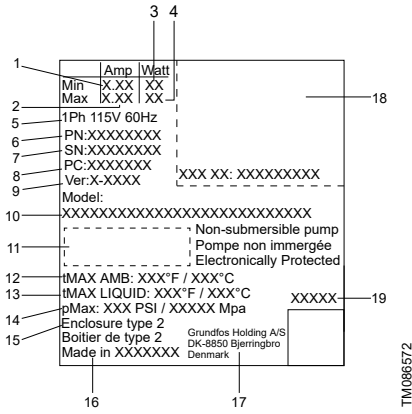

TM086572

Pos.	Description
1	Min. current consumption
2	Max. current consumption
3	Min. power consumption
4	Max. power consumption
5	Number of phases, voltage and frequency
6	Product number
7	Serial number
8	Factory code and production code (year and week)
9	Version letter and update number
10	Pump model
11	Enclosure class
12	Max. ambient temperature
13	Max. liquid temperature
14	Max. system pressure
15	Enclosure type
16	Country of origin
17	Grundfos address
18	Approvals
19	Combined legal product code

2.4.2 Type key

Example: ALPHA HWR 15-29 SF/T 115V 9H

Code	Explanation	Designation
ALPHA HWR	Grundfos circulator	Pump type
15	R 1/2" G1"	Nominal diameter
55	18 ft (5.5 m)	Max. head
29	9.5 ft (2.9 m)	
S	Stainless steel	Pump housing
U	Union	Pipe connection
F	Flange	
T	Integrated timer	
[]	Conduit box	Power connection
LC	Line cord	
115V	115 V	Voltage
230V	230 V	
3H	3 o'clock (right)	Control box positions
6H	6 o'clock (below)	
9H	9 o'clock (left)	
0H	12 o'clock (top)	

3. Approvals

3.1 Approvals of pump

Approval marks



NSF listing is only valid for temperatures up to 140 °F.



This equipment has been tested and found to comply with the limits for a class B digital device, pursuant to Part 15 of the FCC Rules.



Any changes or modifications to this equipment not expressly approved by the party responsible for compliance could void the user's authority to operate this equipment.

These limits are designed to provide reasonable protection against harmful interference in a residential installation. This equipment generates, uses and can radiate radio frequency energy and, if not installed and used in accordance with the instructions, may cause harmful interference to radio communications. However, there is no guarantee that interference will not occur in a particular installation. If this equipment does cause harmful interference to radio or television reception, which can be determined by turning the equipment off and on, the user is encouraged to try to correct the interference by one or more of the following measures:

- Reorient or relocate the receiving antenna.
- Increase the separation between the equipment and receiver.
- Connect the equipment to an outlet on a circuit different from that to which the receiver is connected.
- Consult the dealer or an experienced radio/TV technician for help.

4. Receiving the product

4.1 Inspecting the product

CAUTION

Crushing of feet

Minor or moderate personal injury

- Wear safety shoes when handling the product.



CAUTION

Sharp element

Minor or moderate personal injury

- Wear protective gloves.



1. Make sure that the delivered product corresponds to the order.
2. Make sure that the voltage and frequency of the product match the voltage and frequency of the installation site.

4.2 Scope of delivery

The box contains the following items:

- 1 pump
- 1 power connector
- 2 screws for the conduit box
- 1 blanking plug
- 2 gaskets
- 1 quick guide
- 1 check valve
- 1 safety instructions booklet.

5. Installation requirements

5.1 Radio frequency radiation exposure information (for Canada and US only)

CAUTION

Radiation

Minor or moderate personal injury



- This equipment complies with FCC and ISED radiation exposure limits set forth for an uncontrolled environment. This equipment must be installed and operated with a minimum distance of 20 cm (0.66 ft) between the radiator and your body.

5.2 Optimal installation and operation

See below for information for optimizing the installation and setting of the product:

- Check the manual of the boiler to ensure the flow of the pump is correctly set.
- ALPHA HWR must be placed in the return line of the system.
- In HWR systems with more than one flow string, make sure that the flow resistance are equal in both strings. Otherwise, the string with the most resistance will have less hot water recirculation and consequently no hot water on demand.
- When mounting the pump, ensure that the shaft is in a horizontal position to avoid air being trapped inside or bearings being worn out too quickly.
- Make sure that you have the proper voltage and that the wires are connected properly (black = phase, white = neutral, green or bare copper = ground).

6. Mechanical installation

WARNING

Electric shock

Death or serious personal injury

- A damaged product must be repaired or replaced by Grundfos or a service workshop authorized by Grundfos.



CAUTION

Crushing of feet

Minor or moderate personal injury

- Wear safety shoes when opening the box and handling the product.



CAUTION

Sharp element

Minor or moderate personal injury

- Wear protective gloves.



The pump must always be installed with a horizontal motor shaft within $\pm 5^\circ$.



The pump is a non-submersible pump.



Due to interference of the touchscreen, keep a distance of minimum 5 mm from the front of the operating panel to all conductive materials, for example, metal cabinets and cables.

6.2 Mounting the product

The arrows on the pump housing indicate the flow direction through the pump. See the figure below.

Note that for certain housings, a check valve can be fitted in the outlet.

1. Fit the two gaskets supplied, if applicable, with the pump when you mount the pump in the pipe.



TM082452

2. Install the pump with a horizontal motor shaft within $\pm 5^\circ$.

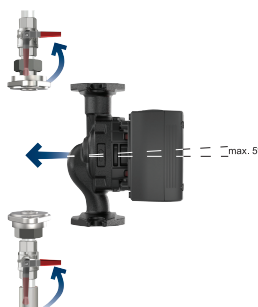

TM082453

3. Tighten the fittings or flange bolts.



TM082454

6.1 Installation diagram

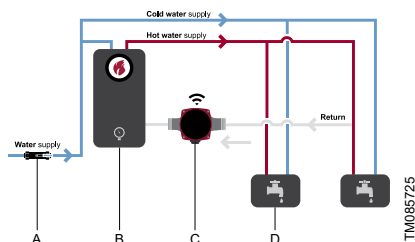

Diagram of ALPHA HWR installation

Pos.	Description
A	Shut-off valve, cold water supply
B	Heater
C	ALPHA HWR
D	Faucet

6.3 Changing the control box position

CAUTION



Hot surface

Minor or moderate personal injury

- Position the pump so that persons cannot accidentally come into contact with hot surfaces.

WARNING

Pressurized system

Minor or moderate personal injury



- Before dismantling the pump, drain the system or close the isolating valves on both sides of the pump. The pumped liquid may be scalding hot and under high pressure.



Make sure that the isolating valves are closed before rotating the control box. The pump must be pressureless before the control box is rotated. Drain the system or relieve the pressure inside the pump housing.

To change the position of the control box, do as follows:

1. Loosen and remove the four screws.

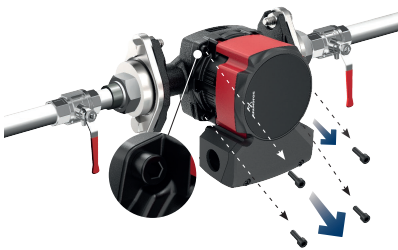

TM082508

2. Turn the pump head to the desired position.



TM082509

You can turn the control box in steps of 90°.

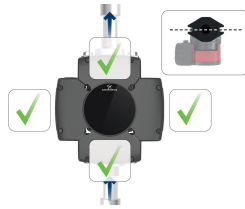

3. Insert and cross-tighten the screws.



TM082458

TM082510

7. Electrical connection

WARNING

Electric shock

Death or serious personal injury

- Switch off the power supply before you start any work on the product. Make sure that the power supply cannot be switched on accidentally.



WARNING

Electric shock

Death or serious personal injury

- Connect the product only to a properly grounded receptacle.



WARNING

Electric shock

Death or serious personal injury

- All electrical connections must be carried out by a qualified electrician in accordance with local regulations.



WARNING

Electric shock

Death or serious personal injury

- Use of the product on a circuit equipped with a GFCI can cause improper operation of the GFCI. Consult an electrician and observe all national, state and local electrical regulations, as applicable.



- The pump is electronically protected and therefore requires no external motor protection.
- Check that the supply voltage and frequency correspond to the values stated on the nameplate.
- Connect the pump to the power supply with the power connector supplied with the pump.

7.1 Wiring the pump

Note that the conduit connector and conduit are not supplied by Grundfos.

Follow the steps below to wire the pump:

1. Remove the lid from the conduit box, attach the conduit connector to the knockout opening and tighten the connector nut.



Use only a flexible conduit.

2. Take the power connector and lift the orange levers, and connect the black wire to L (phase), the white wire to N (neutral), and the green wire to  (ground).



The power connector can be fitted with AWG 20 - AWG 12 wires.

3. Press the orange levers down to tighten the wires.
4. Insert the power connector.
5. Mount the cover on the conduit box.

TM082786

8. Starting up the product

CAUTION

Radiation

Minor or moderate personal injury



- This equipment complies with FCC and ISED radiation exposure limits set forth for an uncontrolled environment. This equipment must be installed and operated with a minimum distance of 20 cm (0.66 ft) between the radiator and your body.

1. Fill the system with liquid and vent it.
2. Make sure the required minimum inlet pressure is available at the pump inlet.
3. Switch on the power supply.

The pump is factory set to temperature control, AUTOADAPT.

You can change the settings on the operating panel or via Grundfos GO. We recommend to follow the guided setup in Grundfos GO.

8.1 Venting the pump



TM083494

Venting the pump

Small air pockets trapped inside the pump may cause noise when starting up the pump. However, because the pump is self-venting through the system, the noise ceases over a period of time. Still, we recommend venting the pump in new installations or when the pipes have been emptied and refilled with water. You can vent the pump via Grundfos GO.

- If you follow the guided setup, you are asked if you want to vent the pump now.

- If you do not follow the guided setup, you can access the venting settings via the **Settings** menu.



The pump must not run dry.
You cannot vent the system through the pump.

8.2 Dry-running protection

The dry-running protection protects the pump against dry running during startup and normal operation.

During startup

If water has not been detected, the pump rotates the impeller back and forward. If water is still not detected, it attempts again after 30 seconds.

The pump stops after maximum 30 attempts, and the spinner icon on the operating panel is spinning (temporary mode).

During normal operation

If dry running is detected during normal operation, the pump stops for 30 minutes and attempts again. After 144 attempts, the pump stops in alarm mode, Grundfos mini Eye flashes red and error code E4 is displayed.

The pump can be restarted by pressing anywhere on the operating panel (except the connect and lock icons). The pump will not detect dry running if dry running has been detected during the past 25 hours. If the pump has previously detected water, the pump can sustain 25 hours of dry-running operation.

9. Control functions

9.1 Operating panel

LED symbols and buttons on the pump display

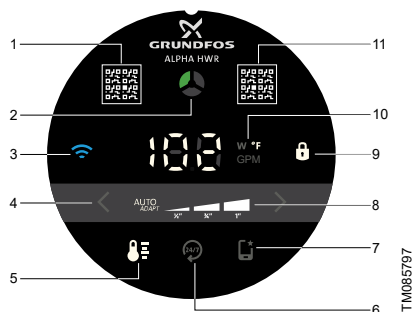

TMC085797

The operating panel has a touchscreen which means you can change settings by touching the icons on the operating panel.

Pos.	Description
1	QR code for Grundfos Product Center Grundfos mini Eye
2	The indicator light shows the operating status of the product. Connect
3	If lit, the pump is connected to Grundfos GO via Bluetooth. Settings for control modes
4	Use the arrows to toggle between the control modes. Control mode
5	This indicates the selected control mode: AUTOADAPT or temperature controlled.
6	Always on Grundfos GO
7	The pump has been set via Grundfos GO.
8	Settings for the selected control mode 1/2", 3/4", 1" or AUTOADAPT

Pos.	Description
9	Lock This indicates that the operating panel is locked and no buttons can be used. It automatically locks after a few seconds. To unlock the panel, push and hold the icon for 1 second.
10	Unit The indicator light shows the unit used for the number to the left. W = Watt, °F = temperature and GPM = gallons per minute.
11	QR code for Grundfos GO and Grundfos HOME landing page











Due to interference of the touchscreen, keep a distance of minimum 5 mm from the front of the operating panel to all conductive materials, for example, metal cabinets and cables.

9.2 Light fields indication

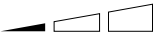
The LEDs indicate the control mode, setting and operating status.

Factory setting

The pump is factory set to temperature control, AUTOADAPT.

Active light fields	Description
	When the pump is set via Grundfos GO, the icon is lit and the modes and settings on the operating panel are switched off.
	Temperature control A temperature algorithm runs the pump and keeps a preset constant temperature. The pump runs in AUTOADAPT constant curve III with 1.5 gpm until one of the stop conditions are met.
	Setting 1/2" - constant curve III with 1.5 gpm max. flow rate
	 Setting 3/4" - constant curve III with 2.3 gpm max. flow rate
	Setting 1" - constant curve III with 3.8 gpm max. flow rate
	The pump is running. ¹⁾
	Warning ¹⁾
	Alarm

1) The rotation of Grundfos mini Eye follows the direction of rotation of the impeller. The impeller in ALPHA rotates counterclockwise.

9.3 Control modes

The product can be set to the following control modes via the operating panel:

- temperature control - AUTOADAPT
- temperature control
- continuous operation - 24/7.

The below control modes can be set via the Grundfos GO app:

- cycle time control
- constant curve
- constant pressure
- constant flow.

9.3.1 Temperature control - AUTOADAPT

This control mode ensures comfort via the integrated temperature estimator and is suitable for all hot-water recirculation applications with a dedicated return line.

The pump adjusts the flow according to the temperature setpoint and ensures hot water is available throughout the house. At the same time, the pump also ensures that the minimum flow requirement to activate tankless water heaters is met. The flow rate automatically adjusts between 1 and 4 gpm while maintaining a temperature between 95 and 102 °F (35 and 39 °C).

9.3.2 Temperature control

This control mode ensures comfort via flow limits based on predefined pipe diameters.

The pump maintains a temperature between 95 and 102 °F (35 and 39 °C). The setpoints have maximum flow limits that are based on predefined pipe diameters and are designed to reduce flow accelerated corrosion. The pump operates on its maximum curve until it reaches the flow limits which are defined as below:

- 1/2" 1.5 gpm)
- 3/4" (2.3 gpm)
- 1" (3.8 gpm).

9.3.3 Continuous operation - 24/7

This control mode ensures comfort 24/7 through continuous operation in constant curve III with flow limits.

The flow limits are based on predefined pipe diameters and flow limits (see below) to reduce flow accelerated corrosion and noise in the system. The predefined flow limits can be changed via Grundfos GO.

- 1/2" 1.5 gpm)
- 3/4" (2.3 gpm)
- 1" (3.8 gpm).

9.3.4 Cycle time control

The pump operates at its maximum curve, and it starts and stops based on time parameters. The default time parameters are 5 minutes on and 15 minutes off. The time parameters are adjustable through Grundfos Go.

9.3.5 Constant curve

The pump operates at a constant curve, which means that it runs at constant speed or power. The pump performance follows the selected constant curve.

This control mode is recommended in systems replacing old three-speed circulators where the required performance is known.

9.3.6 Constant pressure

The pump operates at a constant pressure which means the head is kept constant regardless of changes in the system. The pump performance follows the selected constant-pressure curve.

This control mode is recommended in systems with multiple risers and thermally actuated balancing valves.

9.3.7 Constant flow

The pump operates at a constant flow in the system regardless of the head.

This control mode is recommended when the pump is externally controlled, for example with an aquastat.

10. Setting of the product

CAUTION

Radiation

Minor or moderate personal injury



- This equipment complies with FCC and ISED radiation exposure limits set forth for an uncontrolled environment. This equipment must be installed and operated with a minimum distance of 20 cm (0.66 ft) between the radiator and your body.

The operating panel can be used for the following:

- Connect to Grundfos GO.
- Lock and unlock the operating panel.
- Select the temperature control.
- Select pump setting (1/2", 3/4, 1" system pipe size or AUTOADAPT) for the temperature control mode.
- Select to operate with Grundfos GO settings.

In Grundfos GO you can access all settings.

10.1 Connecting the product to Grundfos GO

Before connecting the product to Grundfos GO, the Grundfos GO app must be downloaded to your smartphone or tablet. The app is free of charge and available for iOS and Android devices.

The connection can be started either from the operating panel or Grundfos GO. If you have several products installed, we recommend starting the connection from the operating panel.

1. Open Grundfos GO on your device. Make sure that Bluetooth is enabled.
Your device must be within reach of the product to establish Bluetooth connection.
2. Go to the **Remote** menu in Grundfos GO.
3. Press the connect icon on the operating panel. The connect icon flashes until your device is connected.
4. Press **CONNECT** in Grundfos GO.
Once the connection is established, the LED is permanently on.
Grundfos GO is now loading the data for the product.

10.2 Guided setup

After the pump is connected to Grundfos GO, we recommend that you follow the guided setup in Grundfos GO.

The guided setup helps you to select the optimal settings for the current system. By choosing the optimal settings, you can lower the energy consumption and prevent potential noise problems.

If you select **Use default settings**, the pump uses the factory setting, constant curve (zone pump), AUTOADAPT.

10.3 Air detection and system venting

ALPHA offers a **Continuous air detection and venting** feature which means the pump can detect air and push it quickly to the system vent. If the pump detects air, it runs a venting sequence which enables more air to escape compared to letting the pump run at maximum speed during the entire process.

During system venting, the air is pushed to the system vent.

The function can be enabled in Grundfos GO in the **Settings** menu.

During the guided setup, you are asked if you want to vent the pump and system now. This is only a single event, and it will not enable this function.

10.4 Flow limitation

You can set a minimum and maximum flow rate in Grundfos GO.

A minimum flow limit can be set to prevent the boiler from overheating. A maximum flow limit can be set to prevent noise in the system.

10.5 Trend data

In the **Trend data** menu in Grundfos GO, you can see system data for the last 10 or 100 on-cycles. An on-cycle is the period from when the pump turns on until it turns off. If the pump runs continuously for more than 24 hours, one on-cycle is registered and a new on-cycle will start even though the pump has not yet turned off. The 100 cycles view consists of 10 observations where each observation is the average of 10 on-cycles.

You can see the following data:

- **Duration of each on-cycle**
- **Flow**
- **Head**
- **Estimated media temperature.**

You can use the trend data for system optimization and fault finding.

10.6 Updating the software

Follow the steps below to update the product's software via Grundfos GO:

1. Make sure your smart device has sufficient power.
2. Make sure your smart device is connected to the internet.

If there is no internet where the pump is installed, go to step 3 and then follow the instructions in Grundfos GO.

3. Connect your product to Grundfos GO if it is not already connected.

The app automatically checks if the product has the latest software installed. If a newer version is available, the text **New software available** appears on the dashboard in Grundfos GO. You can also check for software updates in the **Settings** menu.

4. Follow the guide in Grundfos GO to install the software update.

10.7 Resetting to factory settings

The product can be reset to factory settings in two ways:

- **Via Grundfos GO**
 1. Open Grundfos GO.
 2. Press the gear icon in the top right side of the screen.
 3. Go to the **Factory reset** menu and press **Reset**.
- **Via the operating panel**
 1. Press and hold the unit icon for 5 seconds.

11. Service

WARNING

Electric shock

- All electrical connections must be carried out by a qualified electrician in accordance with local regulations.



WARNING

Electric shock

- Switch off the power supply before you start any work on the product. Make sure that the power supply cannot be switched on accidentally.



WARNING

Electric shock

- A damaged product must be repaired or replaced by Grundfos or a service workshop authorized by Grundfos.



WARNING

Electric shock

- Connect the product only to a properly grounded receptacle.



WARNING

Pressurized system

- Before dismantling the pump, drain the system or close the isolating valves on both sides of the pump. Slowly loosen the screws and unpressurize the system. The pumped liquid may be scalding hot and under high pressure.



WARNING

Hot surface

- The pump housing may be hot due to the pumped liquid being scalding hot. Close the isolating valves on both sides of the pump and wait for the pump housing to cool down.



CAUTION

Sharp element

- Wear protective gloves.



CAUTION

Crushing of feet

- Minor or moderate personal injury
- Wear safety shoes when moving the product.



CAUTION

Explosive environment

- Minor or moderate personal injury
- Risk of explosion if the battery is replaced by an incorrect type.
- Dispose of used batteries according to the instructions.



CAUTION

Radiation

- Minor or moderate personal injury
- This equipment complies with FCC and ISED radiation exposure limits set forth for an uncontrolled environment. This equipment must be installed and operated with a minimum distance of 20 cm (0.66 ft) between the radiator and your body.



12. Fault finding

WARNING

Electric shock

Death or serious personal injury



- Switch off the power supply before you start any work on the product. Make sure that the power supply cannot be switched on accidentally.

WARNING

Electric shock

Death or serious personal injury



- A damaged product must be repaired or replaced by Grundfos or a service workshop authorized by Grundfos.

WARNING

Hot surface

Minor or moderate personal injury



- The pump housing may be hot due to the pumped liquid being scalding hot. Close the isolating valves on both sides of the pump and wait for the pump housing to cool down.

CAUTION

Pressurized system

Minor or moderate personal injury



- Before dismantling the pump, drain the system or close the isolating valves on both sides of the pump. The pumped liquid may be scalding hot and under high pressure.

CAUTION

Radiation

Minor or moderate personal injury





- This equipment complies with FCC and ISED radiation exposure limits set forth for an uncontrolled environment. This equipment must be installed and operated with a minimum distance of 20 cm (0.66 ft) between the radiator and your body.

12.1 Fault indication on the pump operating panel

Faults preventing the pump from operating properly are indicated on the operating panel with Grundfos mini Eye turning either yellow or red and the display showing an error code.





A warning is indicated when one indicator light in Grundfos mini Eye is turning yellow and rotating. The pump does not perform as expected, and action is required in case of underheating or discomfort.

An alarm is indicated when two indicator lights in Grundfos mini Eye are flashing red and the pump stops. Action is required.

Grundfos mini Eye	Description
	Warning indication
	Alarm indication

12.2 Overview of alarm and warning codes

Fault chart

Grundfos mini Eye	Code on operating panel	Code in Grundfos GO	Fault
	E1	51	Blocked motor
	E2	40	Undervoltage
		29	Forced pumping
		4	Overvoltage
	E3	72	Internal fault
		76	Internal fault
		85	Internal fault
	E4	57	Dry running
	E3	43	Impellers forced forward
	- 2)	35	Air in media

2) This error is not shown on the operating panel. It is logged and can be seen in Grundfos GO.

12.3 Resetting alarms and warnings manually with Grundfos GO

1. Go to **Alarms and warnings**.
2. Press **Reset alarm**.
All current alarms and warnings have been reset. However, if the fault causing the alarm or warning has not been removed, the alarm or warning will appear again.
3. If you want to delete all alarms and warnings from the history log, press **Show log > Reset alarm and warning logs**.

12.4 Alarm and warning code logs

Grundfos GO will save up to 40 alarms and warnings in total in the **Alarms and warnings** menu.

12.5 Automatic deblocking

In case of a blocked rotor, the pump will start vibrating automatically with a frequency of around 3 Hz during startup. Any dirt deposits that might prevent the impeller from rotating will be broken up swiftly, and the pump will resume normal operation.

12.6 Overheated boiler

Cause	Remedy
The flow is too low.	<ul style="list-style-type: none"> • Increase the flow.

12.7 Noise in the system

Cause	Remedy
The flow is too high.	<ul style="list-style-type: none"> • Lower the flow.
There is air in the system	<ol style="list-style-type: none"> 1. Connect to Grundfos GO. 2. Select the Settings menu. 3. Select Vent pump (15 minutes). 4. Press Start venting.

12.8 Alarms

12.8.1 Code 51 (Blocked motor)

Grundfos mini Eye is flashing red, the displays show error code **E1** and the pump stops.

Cause	Remedy
The pump is blocked.	Only a qualified specialist must perform such work. <ol style="list-style-type: none"> 1. Isolate the pump. 2. Remove the pump head. 3. Remove the deposits.

12.8.2 Code 40 (Undervoltage)

Grundfos mini Eye is flashing red, the displays show error code **E2** and the pump stops.

Cause	Remedy
The supply voltage to the pump is too low.	<ul style="list-style-type: none"> • Make sure that the power supply is within the specified range.

12.8.3 Code 29 (Forced pumping)

Grundfos mini Eye is flashing red, the displays show error code **E3** and the pump stops.

Cause	Remedy
Other pumps or sources generate flow through the pump even if the pump is switched off.	<ul style="list-style-type: none"> • Switch off the pump at the main switch. If the light in the pump display is on, the pump is running in forced pumping mode. • Check the system for the correct position of the non-return valves. • Check the system for defective non-return valves and replace the valves if necessary.

12.8.4 Code 74 (Overvoltage)

Grundfos mini Eye is flashing red, the displays show error code **E3** and the pump stops.

Cause	Remedy
The supply voltage to the pump is too high.	<ul style="list-style-type: none"> • Make sure that the power supply is within the specified range.

12.8.5 Code 72 (Internal fault)

Grundfos mini Eye is flashing red, the displays show error code **E3** and the pump stops.

Cause	Remedy
Internal fault.	<ul style="list-style-type: none"> • Replace the pump and dispose in an environmentally sound way according to local regulations, or contact Grundfos Service.

12.8.6 Code 76 (Internal fault)

Grundfos mini Eye is flashing red, the displays show error code **E3** and the pump stops.

Cause	Remedy
Internal fault.	<ul style="list-style-type: none"> Replace the pump and dispose in an environmentally sound way according to local regulations, or contact Grundfos Service.

12.8.7 Code 85 (Internal fault)

Grundfos mini Eye is flashing red, the displays show error code **E3** and the pump stops.

Cause	Remedy
Internal fault.	<ul style="list-style-type: none"> Replace the pump and dispose in an environmentally sound way according to local regulations, or contact Grundfos Service.

12.8.8 Code 57 (Dry running)

Grundfos mini Eye is flashing red, the displays show error code **E4** and the pump stops.

Cause	Remedy
Water is missing in the system or the system pressure is too low.	<ul style="list-style-type: none"> Fill the system with the correct amount of liquid. Prime and vent the pump before a new startup.

12.9 Warnings**12.9.1 Code 43 (Impellers forced forward)**

One indicator light in Grundfos mini Eye is yellow and rotating, the display shows error code **E3** and the pump is running.

Cause	Remedy
Other pumps or sources generate flow through the pump even if the pump is switched off.	<ul style="list-style-type: none"> Switch off the pump at the main switch. If the light in the pump display is on, the pump is running in forced pumping mode. Check the system for the correct position of the non-return valves. Check the system for defective non-return valves and replace the valves if necessary.

12.9.2 Code 35 (Air in media)

This is not shown on the operating panel. It is logged and can be seen in Grundfos GO.

Cause	Remedy
There is air in the pump and/or system.	<ul style="list-style-type: none"> Vent the pump and system. If the problem persists, investigate the system for leakages.

13. Technical data

Flow rate (Q)	15-55: max. 13.6 gpm (3.1 m ³ /h)
	15-29: max. 11 gpm (2.5 m ³ /h)
Head (H)	15-55: max. 18 ft (5.5 m)
	15-29: max. 9.5 ft (2.9 m)
Supply voltage	1 × 115 V, ± 10 %, 60 Hz
Motor protection	The pump requires no external motor protection.
Power usage (approximate)	15-55: min. 2 - max. 38 W
	15-29: min. 2 - max. 21 W
Enclosure class	Indoor use only. Enclosure type 2.
Insulation class	F
Ambient temperature	32-131 °F (0-55 °C)
Liquid temperature	36-203 °F (2-95 °C) ³⁾
Relative humidity	Max. 95 %
Max. outlet pressure	175 psi (12 bars) (1.2 MPa)
Sound pressure level	< 25 dB(A) cULus and FCC
Approvals	The product complies to limits for class B digital device, pursuant to Part 15 of the FCC Rules.
Port-to-port length	Flange: 6.5" (165 mm)
	Union: 5.9" (150 mm)
Pump housing	Stainless steel
Connection type	Flanged connection
	Union

³⁾ Hard water deposits can occur at temperatures over 140 °F (60 °C).

Inlet pressure

Liquid temperature [°F (°C)]	Min. inlet pressure [psi (bar)]
167 (75)	0.75 (0.05)
203 (95)	7.25 (0.5)
230 (110)	15.7 (1.08)

14. Disposing of the product

This product or parts of it must be disposed of in an environmentally sound way.

1. Use the public or private waste collection service.
2. If this is not possible, contact the nearest Grundfos company or service workshop.

See also end-of-life information at www.grundfos.com/product-recycling.

15. Document quality feedback

To provide feedback about this document, scan the QR-code using your phone's camera or a QR code app.



[Click here to submit your feedback](#)

Limited consumer warranty

1. Limited consumer warranty

This Limited Warranty is provided for Consumer Products sold in the United States only and applies to Consumer Transactions as defined in and applicable under the Magnusson-Moss Warranty Act and any other applicable Federal and/or State laws. In case of non-Consumer Products, please refer to Grundfos' warranty terms defined in clause 10 of Grundfos US Terms and Conditions of Sale of Product and Services available at <https://www.grundfos.com/legal/grundfos-customer-terms/usa-grundfos-general-terms-for-sales-of-products-and-services>

This Limited Warranty gives you specific legal rights, and you may also have other rights which vary from State to State.

New products manufactured by Grundfos are warranted to the original purchaser only and are to be free from defects in design, material and workmanship under normal use and service for no greater than a period of thirty (30) months from the date of manufacture which is set forth on the product's nameplate and on the product's packaging or the minimum period required by the applicable State law. For New Jersey, the applicable period is one year from the date of purchase.

The warranty period for replacement products, parts and components expires thirty (30) months from the original date of manufacture of the product originally purchased, unless a longer period is required under the applicable State law. For New Jersey, the warranty period for replacement products, parts and components expires one year from the original date of purchase of the product, not the date of replacement.

Products sold by Grundfos that are manufactured by others are not covered by this warranty.

Note that when purchasing a Grundfos product online, it is important to check the date of manufacture and the duration of the warranty with the seller as the product might no longer be covered under this Limited Warranty.

When a product is subject to this Limited Warranty a purchaser should contact the seller from which it purchased the product to make a claim.

If the seller of a product is no longer in business, the purchaser should contact a Grundfos Authorized Service Partner, which can be found at www.grundfos.com/us under > Support > Contact Service.

As part of making a claim, a purchaser shall return a defective product at the purchaser's cost, to the extent allowed by applicable law, along with proof of purchase and an explanation of the defect, date the defect occurred and circumstances surrounding the defect. For New Jersey there is no prohibition on returning a defective product at a purchaser's cost. If Grundfos is required by applicable State law to pay for the cost of shipment under applicable State law, then a purchaser should contact a Grundfos Authorized Service Partner to arrange for shipment. A purchaser also needs to promptly respond to Grundfos as to any inquiries regarding a warranty claim.

Grundfos' liability under this Limited Warranty to purchaser is limited to the repair or replacement of a product (at Grundfos' decision) that is the sole and exclusive remedy for purchaser to the extent permissible by applicable law. For New Jersey this limitation is permissible.

This warranty does not cover the following: ordinary wear and tear; use of a product for applications for which it is not intended; use of a product in an unsuitable environment; modifications, alterations or repair undertaken by anyone not acting with Grundfos' written authorization; failure to follow Grundfos' instructions, operations manuals, any other guidelines or good industry practice; use of faulty or inadequate ancillary equipment in combination with a product; application of spare or replacement parts not provided or authorized by Grundfos; accidental or intentional damage or misuse of a product.

The time period for making a claim under the implied warranty of merchantability and implied warranty of fitness are limited to the same time period as provided by this warranty to the extent permissible by applicable law. For residents of New Jersey, this limitation is permissible, but note that some states do not allow limitations on how long an implied warranty lasts, so the above limitation may not apply to you.

Grundfos shall not be liable for any incidental and consequential damages in connection with a product to the extent permissible by applicable law. For residents of New Jersey, this limitation is permissible, but note that some states do not allow limitations of incidental or consequential damages, so the above limitation may not apply to you.

2. Garantía limitada del consumidor

Esta garantía limitada se proporciona únicamente para los productos de consumo vendidos en los Estados Unidos y es aplicable a las transacciones de consumo tal y como se define en y resulta aplicable en virtud de la ley de Garantías Magnusson-Moss y cualquier otra legislación federal y/o estatal aplicable. Para el caso de productos que no sean de consumo, consulte los términos de la garantía de Grundfos definidos en la cláusula 10 de los términos y condiciones de venta de productos y servicios de Grundfos para los EE. UU., disponibles en <https://www.grundfos.com/legal/grundfos-customer-terms/usa-grundfos-general-terms-for-sales-of-products-and-services>.

Esta garantía limitada le confiere derechos legales específicos. Puede que también tenga otros derechos en virtud de su jurisdicción estatal.

Se garantiza únicamente al comprador original que los productos fabricados por Grundfos estarán libres de defectos de diseño, materiales y mano de obra en condiciones normales de uso y servicio durante un periodo no mayor a treinta (30) meses a partir de la fecha de fabricación que figura en la placa de datos del producto y en el empaque del mismo o el periodo mínimo exigido por la legislación estatal aplicable. Para Nueva Jersey, el periodo aplicable es de un año a partir de la fecha de compra.

El periodo de garantía para los productos, partes y componentes de repuesto vence a los treinta (30) meses contados a partir de la fecha de fabricación original del producto adquirido en primer lugar, a menos que la legislación estatal aplicable exija un periodo más largo. Para Nueva Jersey, el periodo de garantía de los productos, partes y componentes de repuesto vence un año contado a partir de la fecha original de compra del producto, no de la fecha de sustitución.

Los productos vendidos por Grundfos que sean producidos por otros fabricantes no están cubiertos por esta garantía.

Tenga en cuenta que, al comprar un producto Grundfos en línea, es importante revisar la fecha de fabricación y la duración de la garantía con el vendedor, ya que es posible que el producto ya no esté cubierto por esta garantía limitada.

Cuando un producto esté sujeto a esta garantía limitada, el comprador deberá ponerse en contacto con el vendedor al que haya comprado el producto para presentar una reclamación.

Si el vendedor de un producto ya no está en el negocio, el comprador debe ponerse en contacto con socio de servicio autorizado por Grundfos, que puede encontrar en la dirección www.grundfos.com/us, en la sección "Support" > "Contact Service".

Como parte de la presentación de una reclamación, el comprador deberá devolver el producto descompuesto a su costa, en la medida en la que lo permita la legislación aplicable, junto con el comprobante de compra y una explicación del defecto, la fecha en que este se haya producido y las circunstancias en torno al defecto. En Nueva Jersey no existe ninguna prohibición de devolver un producto descompuesto a costa del comprador. Si la legislación estatal aplicable obliga a Grundfos a hacerse cargo de los gastos de envío, el comprador deberá ponerse en contacto con un servicio técnico autorizado por Grundfos para organizar el envío. El comprador también debe responder con prontitud a Grundfos cualquier consulta relacionada con una reclamación de garantía.

La responsabilidad de Grundfos hacia el comprador en virtud de esta garantía limitada se limita a la reparación o sustitución de un producto (a decisión de Grundfos), que es el único y exclusivo remedio para el comprador en la medida permitida por la legislación aplicable. Para Nueva Jersey, esta limitación resulta permisible.

Esta garantía no cubre lo siguiente: el desgaste ordinario; el uso de un producto para aplicaciones para las que no está diseñado; el uso de un producto en un entorno inadecuado; las modificaciones, alteraciones o reparaciones realizadas por cualquier persona que no actúe con la autorización por escrito de Grundfos; el incumplimiento de las instrucciones, manuales de operación, cualquier otro lineamiento o las buenas prácticas industriales de Grundfos; el uso de equipos auxiliares descompuestos o inadecuados en combinación con un producto; el uso de repuestos o partes de sustitución no proporcionados ni autorizados por Grundfos; el daño accidental o deliberado o el uso indebido de un producto.

El periodo para presentar una reclamación en virtud de la garantía implícita de comerciabilidad y la garantía implícita de idoneidad se limita al mismo periodo previsto por esta garantía en la medida permitida por la legislación aplicable. Para los residentes de Nueva Jersey, esta limitación resulta permisible, si bien se debe tener en cuenta que algunos estados no permiten limitaciones en cuanto a la duración de una garantía implícita, por lo que la limitación anterior puede no resultar aplicable en su caso.

Grundfos no será responsable de ningún daño indirecto o consecuente en relación con un producto en la medida en la que lo permita la legislación aplicable. Para los residentes de Nueva Jersey, esta limitación resulta permisible, si bien debe tenerse en cuenta que algunos estados no permiten limitaciones en cuanto a daños indirectos o consecuentes, por lo que la limitación anterior puede no resultar aplicable en su caso.

U.S.A.

Global Headquarters for WU
856 Koomey Road
Brookshire, Texas 77423 USA
Phone: +1-630-236-5500

GRUNDFOS CBS Inc.
902 Koomey Road
Brookshire, TX 77423 USA
Phone: 281-994-2700
Toll Free: 1-800-955-5847
Fax: 1-800-945-4777

GRUNDFOS Pumps Corporation
9300 Loiret Boulevard
Lenexa, Kansas 66219 USA
Tel.: +1 913 227 3400
Fax: +1 913 227 3500

Canada

GRUNDFOS Canada inc.
2941 Brighton Road
Oakville, Ontario
L6H 6C9
Tel.: +1-905 829 9533
Fax: +1-905 829 9512

Mexico

Bombas GRUNDFOS de México
S.A. de C.V.
Boulevard TLC No. 15
Parque industrial Stiva Aeropuerto
Apodaca, N.L. 66600
Tel.: +52-81-8144 4000
Fax: +52-81-8144 4010

Revision Info

Last revised on 04-2021

92992175 02.2024

ECM: 1388919

www.grundfos.com

GRUNDFOS 

Trademarks displayed in this material, including but not limited to Grundfos and the Grundfos logo, are registered trademarks owned by The Grundfos Group. © 2024 Grundfos Holding AS, all rights reserved.