

INSTALLATION

G U I D E

BATH DRAIN

THE BOLD LOOK
OF **KOHLER**®

RECOMMENDED TOOLS AND MATERIALS

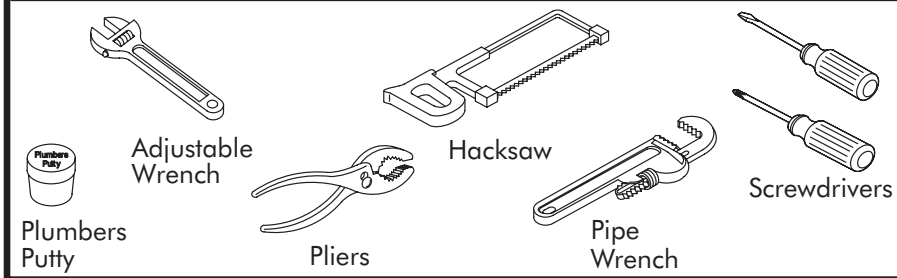

BEFORE YOU BEGIN

- Observe local plumbing codes.
- Install the drain to the bath before installing the bath.
- Kohler Co. reserves the right to make revisions in the design of faucets without notice, as specified in the Price Book.

1. ROUGHING-IN DIMENSIONS

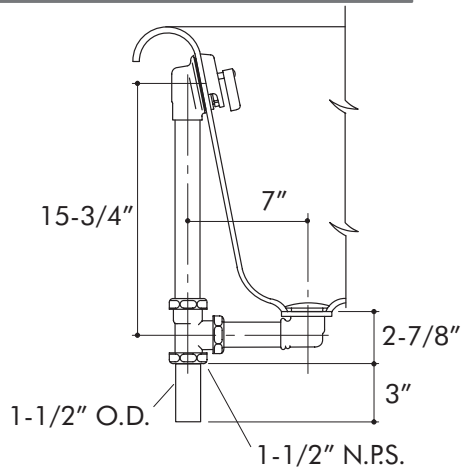

2. INSTALL DRAIN

Apply a ring of plumbers putty or other sealant around the underside of the strainer according to the putty manufacturer's instructions.

Position the gasket between the drain ell and the bottom of the bath. Begin threading the strainer into the drain ell.

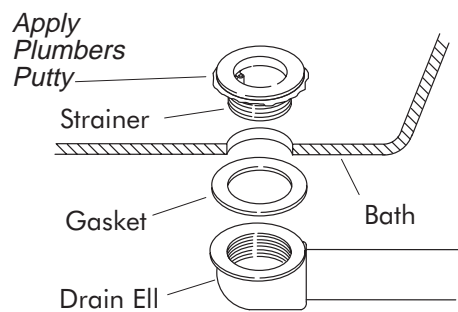

Position the drain ell tube to face the front of the bath. Insert the handle of a pliers into the top of the strainer so the handle contacts the drain ell bosses. Securely tighten the strainer to the drain ell.

Remove any excess sealant.

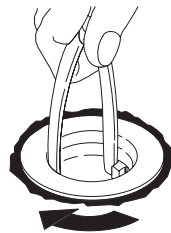

Attach the gasket to the overflow ell, as shown. Make sure the tapered end of the gasket is facing up.

Align the overflow ell with the overflow hole in the bath.

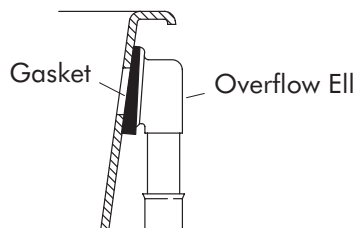

From inside the bath, securely tighten the retainer nut to the overflow ell.

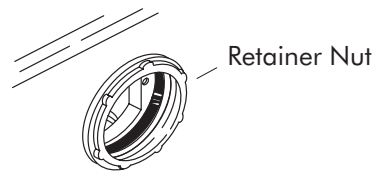

Assemble the coupling nuts and O-rings onto the overflow and drain ell tubes.

Position the tee according to the illustration for your installation. Insert the overflow and drain ell tubes completely into the tee. Align and tighten the coupling nuts.

Apply thread sealant to the tailpiece threads, and thread the tailpiece into the tee.

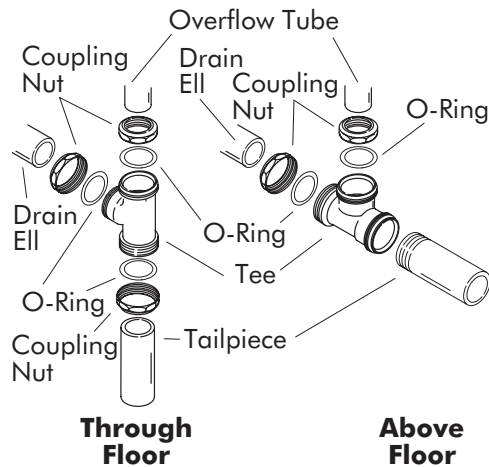

INSTALL THE BATH AT THIS TIME. BE SURE TO FOLLOW ALL INSTRUCTIONS PACKED WITH THE BATH.

Make sure the drain tailpiece fits properly into the trap. You may need to cut the tailpiece for proper fit. Between 1 and 2” of the tailpiece should fit inside the trap.

Adjust the lift assembly linkage by rotating the turnbuckle, and secure by tightening the locknut.

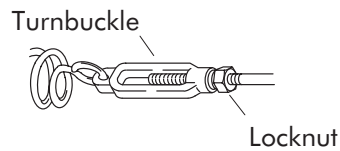

Insert the lift assembly into the overflow. Tighten the overflow hood to the overflow ell with the screws provided.

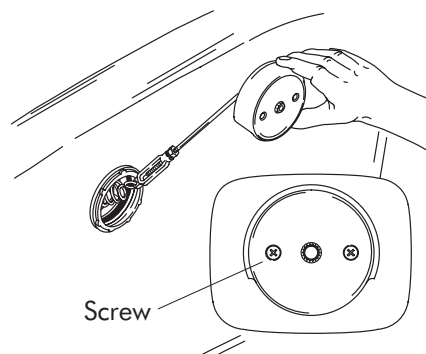

Assemble the lever to the overflow hood with screw.
Turn the lever to the closed position. Insert the stopper assembly into the bath drain hole.

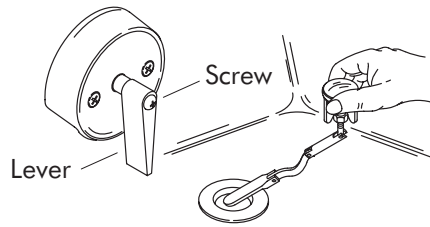

The stopper should rise about 3/8" above the strainer in the open position.

To adjust the height, remove the stopper assembly, and loosen the nut below the stopper. Raise the stopper by turning it counterclockwise; lower by turning clockwise. Retighten the nut.

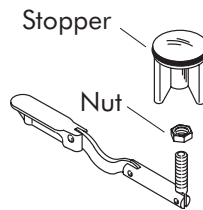

If you cannot obtain sufficient clearance by adjusting the stopper, remove the lift rod assembly, and loosen the locknut. Rotate the turnbuckle counterclockwise to lengthen the lift rod, clockwise to shorten the lift rod. Secure with the locknut, and reinstall the lift rod assembly.

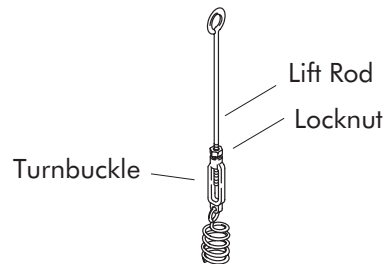

CALL US FOR HELP

Questions? Problems? First review the installation instructions to ensure correct installation. For additional assistance in the USA, call our Customer Service Department for direct help. You may also contact us at our web site listed below.

1-800-4-KOHLER

THE BOLD LOOK
OF **KOHLER**[®]
www.kohlerco.com