



T715

Pro1 Technologies, Inc.

1111 S. Glenstone Ave., Suite 2-100
Springfield, MO 65804

Toll-Free: 888-776-1427 Web: www.pro1iaq.com

Hours of Operation: M-F 9AM - 6PM Eastern

Thermostat Applications Guide

Description	
Gas or Oil Heat	Yes
Electric Furnace	Yes
Heat Pump (No Aux. or Emergency Heat)	Yes
Heat Pump (with Aux. or Emergency Heat)	No
Multi-stage Systems	Yes
Heat Only Systems	Yes
Heat Only Systems - Floor or Wall Furnaces	Yes
Cool Only Systems	Yes
Millivolt	Yes

Power Type

Battery Power
Hardwire (Common Wire)
Hardwire (Common Wire) with Battery Backup

Table of Contents

Page

Installation Tips	2
Thermostat Quick Reference	3
Subbase Installation	4
Wiring	5-6
Technician Setup	7
Technician Setup Menu	8-9
Mounting and Battery Installation	10
Programming The Thermostat	11
Programming The Thermostat (cont)	12
Features and Specifications	13

A trained, experienced technician must install this product.

Carefully read these instructions. You could damage this product or cause a hazardous condition if you fail to follow these instructions.

Una versión en español de este manual se puede descargar en la página web de la compañía.

Wall locations

The thermostat should be installed approximately 4 to 5 feet above the floor. Select an area with average temperature and good air circulation.

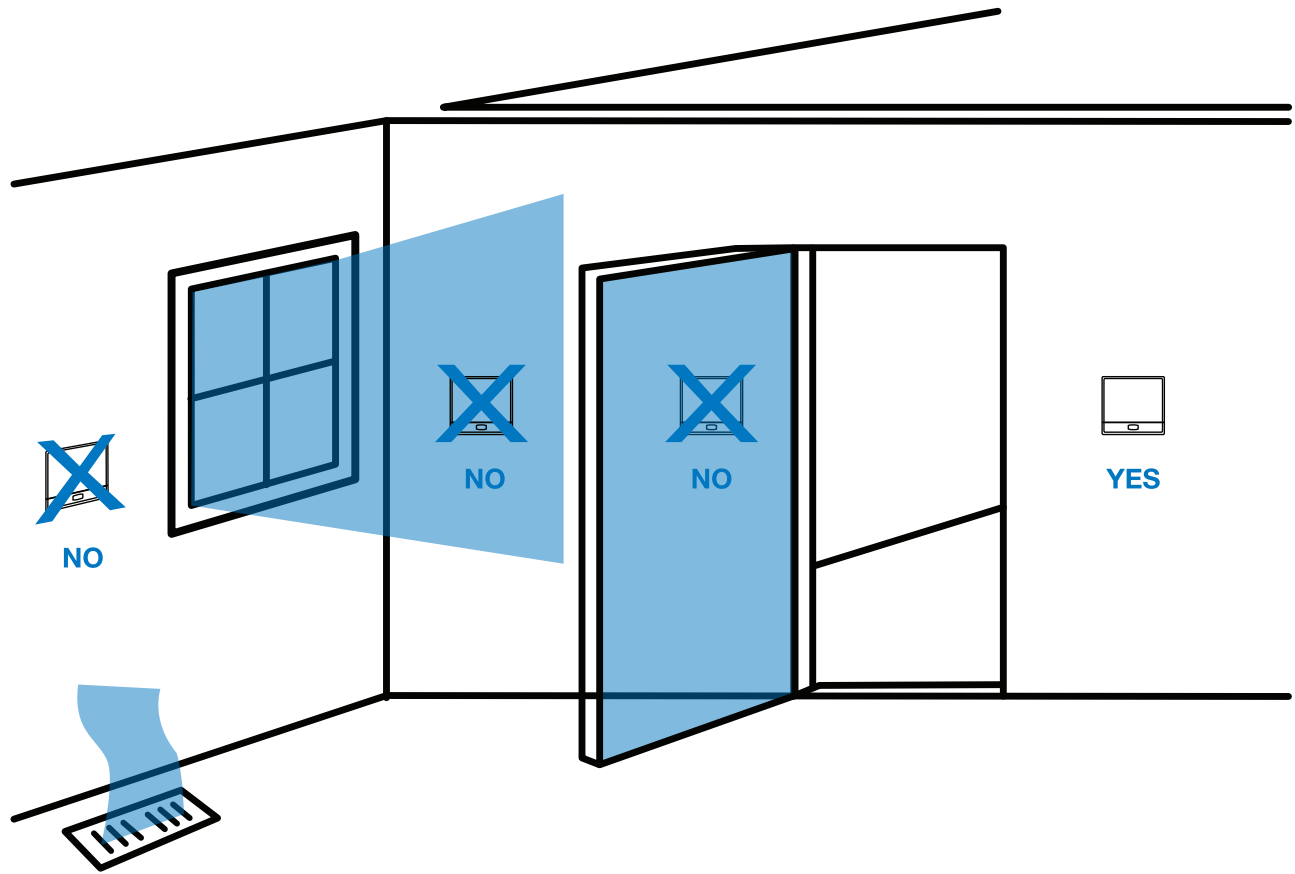

Do not install thermostat in locations:

- Close to hot or cold air ducts
- That are in direct sunlight
- With an outside wall behind the thermostat
- In areas that do not require conditioning
- Where there are dead spots or drafts (in corners or behind doors)
- Where there might be concealed chimneys or pipes
- Where appliances could radiate heat

Installation Tip

Pick an installation location that is easy for the user to access. The temperature of the location should be representative of the building.

Getting to know your thermostat

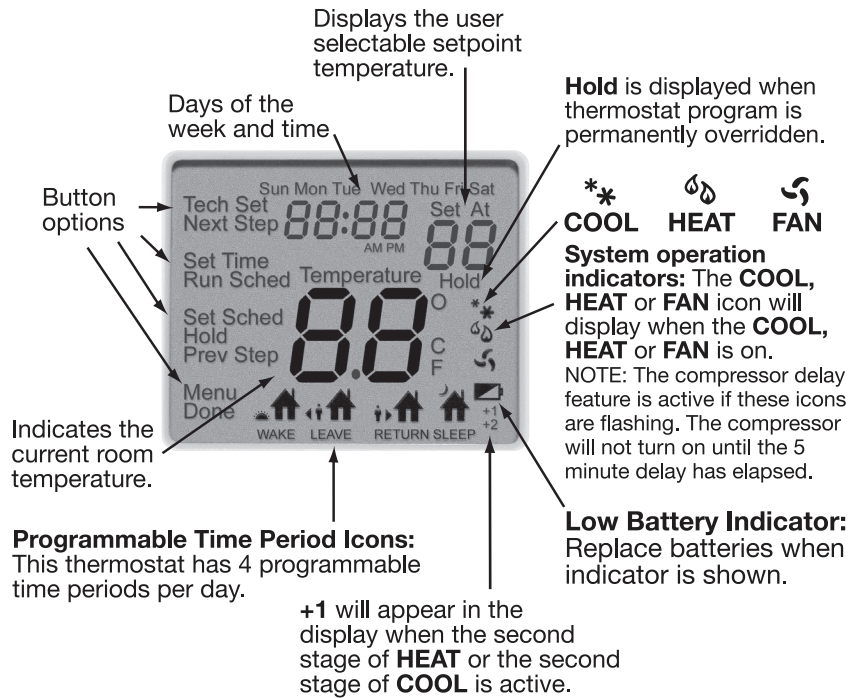
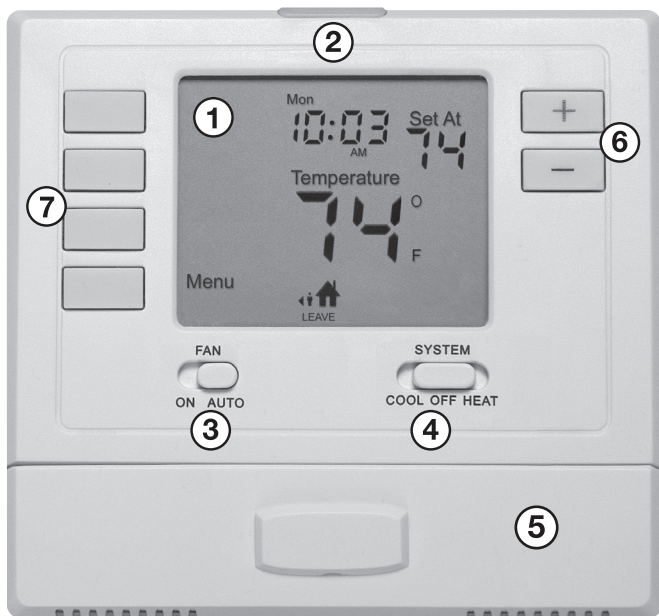

- ① LCD
- ② Glow in the Dark Light Button
- ③ Fan Switch
- ④ System Switch
- ⑤ Easy Change Battery Door
- ⑥ Setpoint Buttons
- ⑦ User Buttons



Important:

The low battery indicator is displayed when the AA battery power is low. If the user fails to replace the battery within 21 days, the screen will only show the low battery indicator but maintain all functionality. If the user fails to replace the batteries after an additional 21 days (days 22-42 since first "low battery" display) the set points will change to 55°F(Heating) and 85°F(Cooling). If the user adjusts these setpoints away from these it will hold for 4 hours then return to either 55°F or 85°F. After day 42 the batteries must be replaced immediately to avoid freezing or overheating because the thermostat will shut the unit off until the battery is changed.

Removing the private label badge

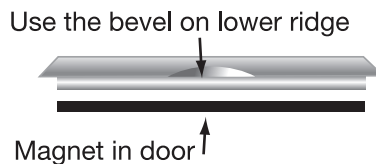
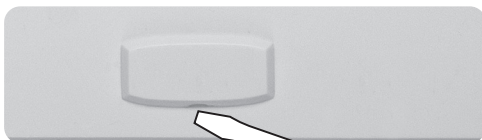

Gently slide a screwdriver into the bottom edge of the badge. Gently turn the screwdriver counter clockwise. The badge is held on by a magnet in the well of the battery door. The badge should pry off easily. **Do not use force.**

About the Badge

All Our thermostats use the same universal magnetic badge. Visit the company website to learn more about our free private label program.



Caution:
Electrical Hazard

Failure to disconnect the power before beginning to install this product can cause electrical shock or equipment damage.



Mercury Notice:

All of Our products are mercury free. However, if the product you are replacing contains mercury, dispose of it properly. Your local waste management authority can give you instructions on recycling and proper disposal.

For vertical mount put one screw top and one screw bottom.

For horizontal mount put one screw left and one screw right.

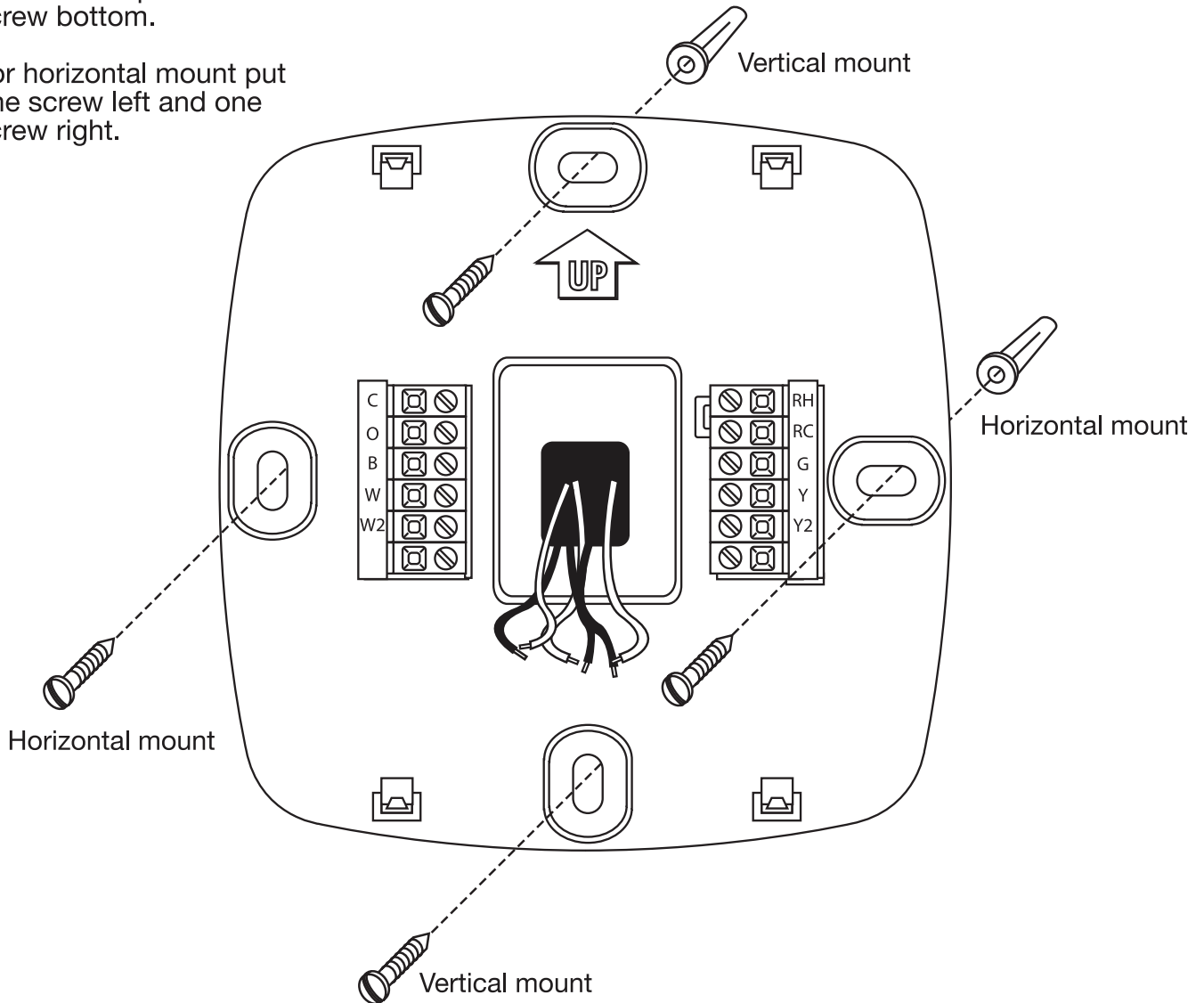



Caution: Electrical Hazard

Failure to disconnect the power before beginning to install this product can cause electrical shock or equipment damage.



Warning:

All components of the control system and the thermostat installation must conform to Class II circuits per the NEC Code.

Wiring

1. If you are replacing a thermostat, make note of the terminal connections on the thermostat that is being replaced. In some cases the wiring connections will not be color coded. For example, the green wire may not be connected to the **G** terminal.
2. Loosen the terminal block screws. Insert wires then retighten terminal block screws.
3. Place nonflammable insulation into wall opening to prevent drafts.



Caution:

Do not overtighten terminal block screws, as this can damage the terminal block. A damaged terminal block can keep the thermostat from fitting on the subbase correctly or cause system operation issues.

Max Torque = 6in-lbs

Terminal Designations

C	Common wire from secondary side of cooling system transformer	RH	Transformer Power for heating
O	Heat Pump changeover valve energized in cooling	RC	Transformer Power for cooling
B	Heat Pump changeover valve energized in heating	G	Fan Relay
W	Heat Relay - Stage 1	Y	Compressor Relay - Stage 1
W2	Heat Relay - Stage 2	Y2	Compressor Relay - Stage 2

Wiring Tip

C terminal

The C (common wire) terminal does not have to be connected when the thermostat is powered by batteries.

Wire specifications

Use shielded or non-shielded 18 - 22 gauge thermostat wire.

New Thermostat Installation Wiring

- ▲ 1 Power supply.
- ▲ 2 Optional 24 VAC common connection when thermostat is used in battery power mode.

Typical 2H/2C system: 1 transformer

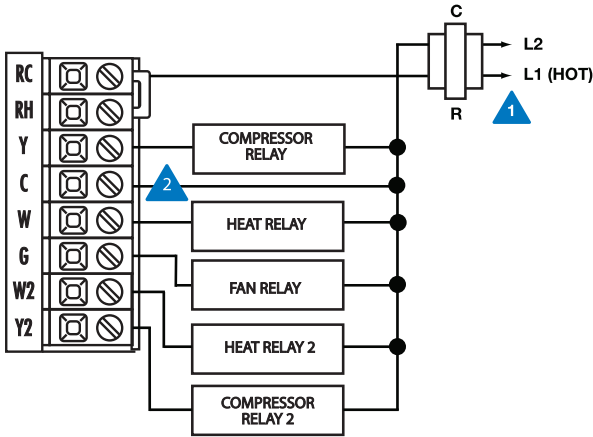

Typical 2H/2C system: 2 transformer

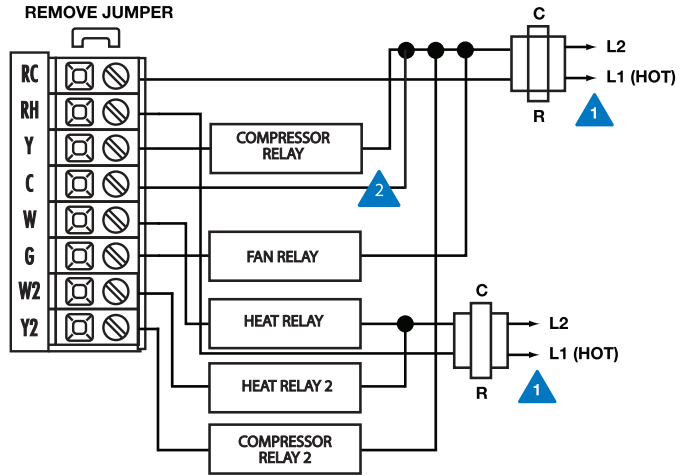

Typical heat-only system

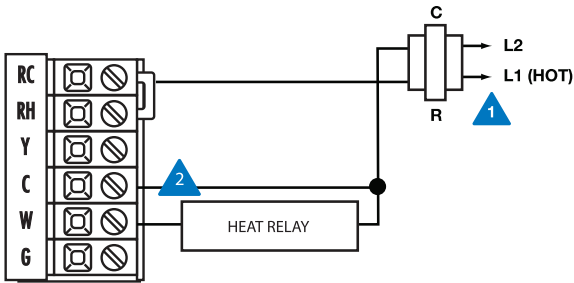

Typical heat-only system with fan

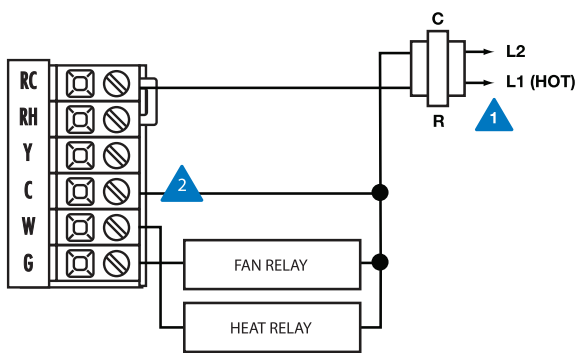

Typical cool-only system

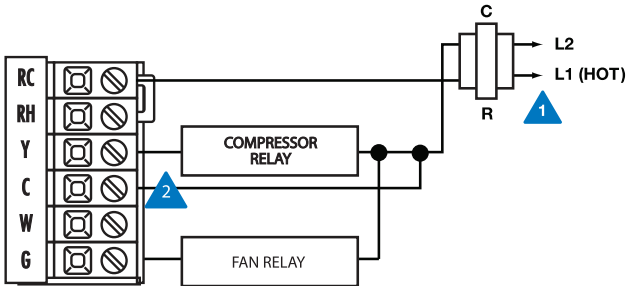

Typical 2H/2C heat pump system w/o Aux.

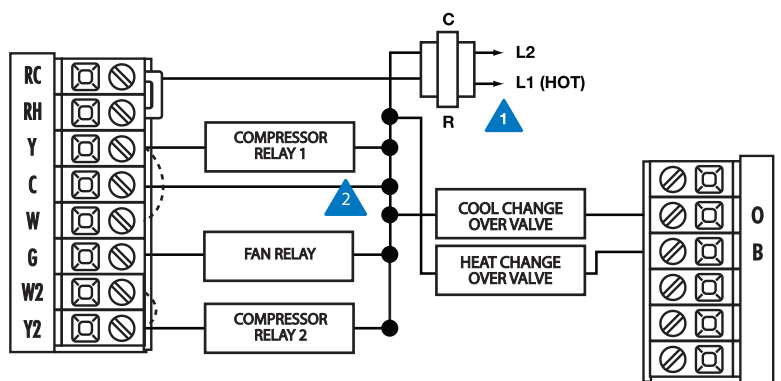

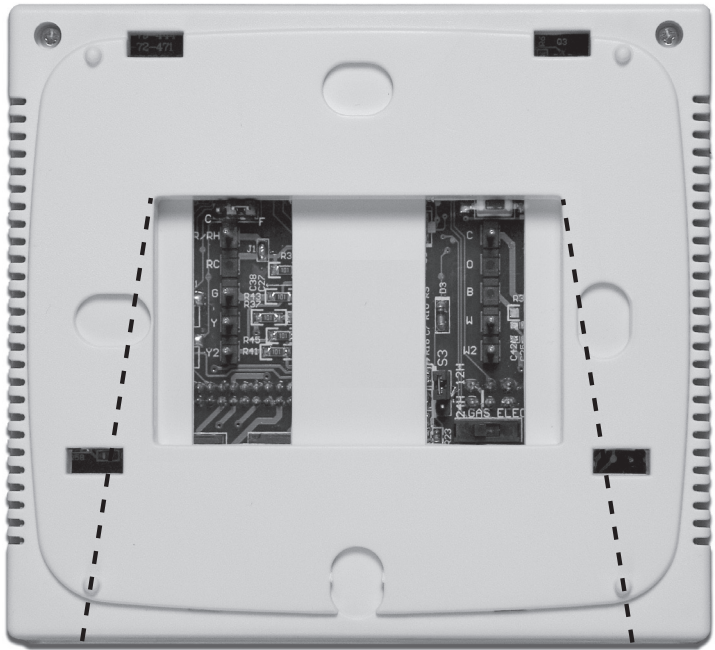

Select **F** or **C** with the jumper pin

Reset button

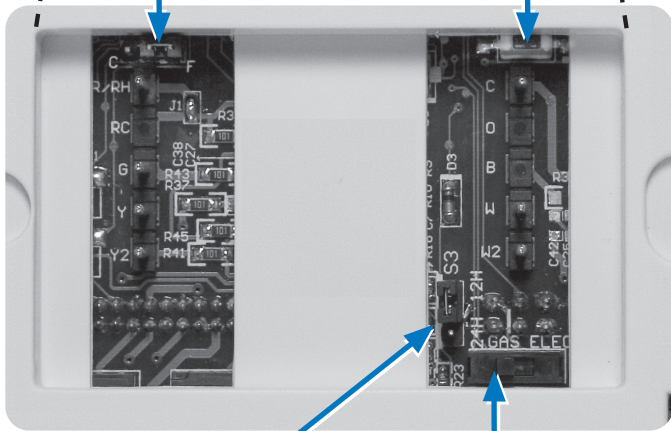

12 or 24 hour jumper pin

Set fan operation switch

Gas or Electric Setup

Gas: For systems that control the fan during a call for heat, put the fan operation switch to the **GAS** position.

Electric: With the operation switch in the **ELEC** position, and the fan relay connected to the G terminal - The thermostat will control the fan during a call for heat.

Fahrenheit/Celsius Display

Select **F** or **C** with the jumper pin on the back of the thermostat. **F** is for Fahrenheit and **C** is for Celsius.

12 or 24 Hour Time

12 or 24 hour (military time) can be selected with the jumper pin.



Important:

The **RESET** button must be pressed after changing any switch or jumper pin setting. Batteries must be installed for this operation.

Technician Setup Menu

This thermostat has a technician setup menu for easy installer configuration. To set up the thermostat for your particular application:

1. Press **MENU** button
2. Press and hold **TECH SET** button for 3 seconds. This 3 second delay is designed so that homeowners do not accidentally access the installer settings.



3. Configure the installer options as desired using the table below.

Use the or keys to change settings and the **NEXT STEP** or **PREV STEP** key to move from one step to another. **Note:** Only press **DONE** key when you want to exit the Technician Setup options.

Tech Setup Steps					
Filter Change Reminder	Room Temperature Calibration	Minimum Compressor On Time	Compressor Short Cycle Delay	Cooling Swing	Heating Swing
This feature will flash "FILT" in the display after the elapsed run time to remind the user to change the filter. A setting of "off" will disable this feature.	This feature allows the installer to change the calibration of the room temperature display. For example, if the thermostat reads 70° and you would like it to read 72° then select +2.	This feature allows the installer to select the minimum run time for the compressor. For example, a setting of 4 will force the compressor to run for at least 4 minutes every time the compressor turns on, regardless of the room temperature.	The compressor short cycle delay protects the compressor from "short cycling". This feature will not allow the compressor to be turned on for 5 minutes after it was last turned off.	The swing setting, often called "cycle rate", "differential" or "anticipation" is adjustable. A smaller swing setting will cause more frequent cycles and a larger swing setting will cause fewer cycles.	The swing setting, often called "cycle rate", "differential" or "anticipation" is adjustable. A smaller swing setting will cause more frequent cycles and a larger swing setting will cause fewer cycles.
LCD Will Show					
Adjustment Options					
You can adjust the filter change reminder from "off" to 2000 hours of runtime in 50 hour increments. Press the second button from the top left side of the thermostat to display the current elapsed runtime hours.	You can adjust the room temperature display to read -4°F to +4°F above or below the factory calibrated reading.	You can select the minimum compressor run time from "off", "3", "4", or "5" minutes. If 3, 4, or 5 is selected, the compressor will run for at least the selected time before turning off.	Selecting "ON" will not allow the compressor to be turned on for 5 minutes after the last time the compressor was on. Select "off" to remove this delay.	The cooling swing setting is adjustable from 0.2°F to 2.0°F. For example: A swing setting of 0.5°F will turn the cooling on at approximately 0.5°F above the setpoint and turn the cooling off at approximately 0.5°F below the setpoint.	The heating swing setting is adjustable from 0.2°F to 2.0°F. For example: A swing setting of 0.5°F will turn the heating on at approximately 0.5°F below the setpoint and turn the heating off at approximately 0.5°F above the setpoint.
Factory Default Settings					
Off	0 °F	Off	On	0.5°F	0.4°F

Swing Setting Tip

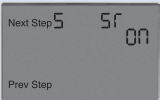
The second stage will turn on at 2x the swing setting. The second stage will turn off when 1x the swing is reached. For example, if the swing setting is .5 degrees for heating and the thermostat is set at 70°F, the first stage will turn on at approximately 69.5°F. The second stage will turn on at 69.0°F. The second stage will turn off at 69.5°F and the first will turn off at 70.5°F.

Tech Setup Steps (Continued...)	
Satisfy Setpoint	Staging Delay
<p>This feature allows the thermostat to keep multiple stages of heat or cool energized until setpoint is satisfied.</p>	<p>This feature allows a delay to occur when a second stage is needed. This allows the previous stage extra time to satisfy setpoint.</p>
LCD Will Show	
	
Adjustment Options	
<p>Use the + or - key to turn on or off.</p>	<p>Use the + or - key to select OFF, 5, 10, 15, 30, 45, 60, or 90 minutes</p>
Factory Default Settings	
OFF	OFF

Understanding Thermostat Staging

Your thermostat will control two stages of heating and cooling. The thermostat will try to maintain your comfort setting using the first stage for energy efficiency. The second stage of heating or cooling will only be used if your thermostat cannot maintain your comfort setting using only one stage. When the second stage is used you will see +1 in the display.

Note:

Our standard staging logic, optional satisfy setpoint, and optional staging delay allows for job by job customization that balances comfort, energy efficiency and equipment longevity.

Mount Thermostat

Align the 4 tabs on the subbase with corresponding slots on the back of the thermostat, then push gently until the thermostat snaps in place.



Battery Installation

Battery installation is recommended even if thermostat is hardwired (C terminal connected). When thermostat is hardwired and batteries are installed, the thermostat will activate a compressor delay of 5 minutes when the thermostat detects a power outage from the hardwired power supply.

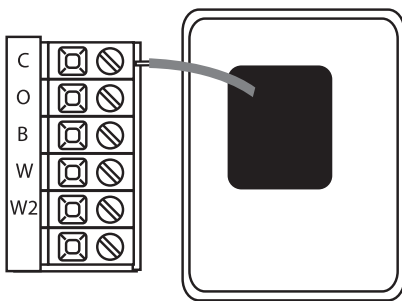

Important:

High quality alkaline batteries are recommended. Rechargeable batteries or low quality batteries do not guarantee a 1-year life span.

Insert 2 AA Alkaline batteries (included). High quality alkaline batteries are recommended.

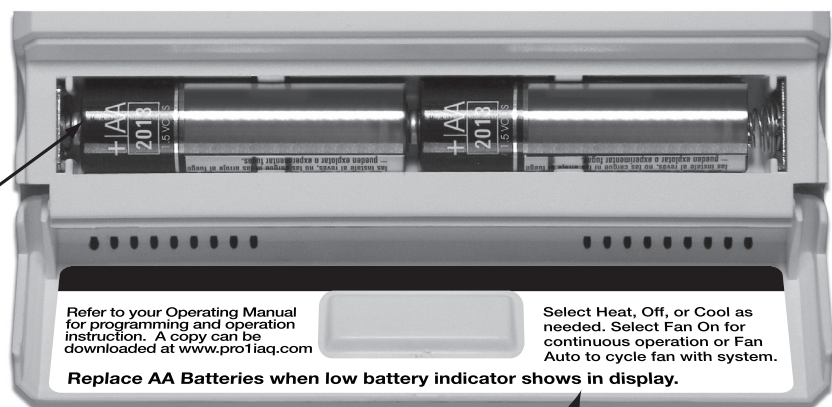

Simple operating instructions are found on the back of the battery door.

Set Time













Follow the steps below to set the day of the week and current time:

1. Press **MENU**
2. Press **SET TIME**
3. Day of the week will be flashing. Use the or key to select the current day of the week.
4. Press **NEXT STEP**
5. The current hour is flashing. Use the or key to select the current hour. When using 12-hour time, make sure the correct a.m. or p.m. choice is selected.
6. Press **NEXT STEP**
7. Minutes are now flashing. Use the or key to select current minutes.
8. Press **DONE** when completed

Programming

All programmable thermostats are shipped with an energy saving pre-program. You can customize this default program by following the Set Program Schedule.













Your thermostat can be programmed to have all the weekdays the same, a separate program for Saturday, and a separate program for Sunday. There are four time periods for each program (**WAKE, LEAVE, RETURN, SLEEP**).

Factory Default Program				
Day of the Week	Events	Time	Setpoint Temperature (Heat)	Setpoint Temperature (Cool)
Weekday	Wake 	6 a.m.	70° F (21° C)	75° F (24° C)
	Leave 	8 a.m.	62° F (17° C)	83° F (28° C)
	Return 	6 p.m.	70° F (21° C)	75° F (24° C)
	Sleep 	10 p.m.	62° F (17° C)	78° F (26° C)
Saturday	Wake 	8 a.m.	70° F (21° C)	75° F (24° C)
	Leave 	10 a.m.	62° F (17° C)	83° F (28° C)
	Return 	6 p.m.	70° F (21° C)	75° F (24° C)
	Sleep 	11 p.m.	62° F (17° C)	78° F (26° C)
Sunday	Wake 	8 a.m.	70° F (21° C)	75° F (24° C)
	Leave 	10 a.m.	62° F (17° C)	83° F (28° C)
	Return 	6 p.m.	70° F (21° C)	75° F (24° C)
	Sleep 	11 p.m.	62° F (17° C)	78° F (26° C)

INSTALLATION MANUAL

PROGRAMMING THE THERMOSTAT

You can use the table below to plan your customized program schedule.

Programming Table				
Day of the Week	Events	Time	Setpoint Temperature (Heat)	Setpoint Temperature (Cool)
Weekday	Wake 			
	Leave 			
	Return 			
	Sleep 			
Saturday	Wake 			
	Leave 			
	Return 			
	Sleep 			
Sunday	Wake 			
	Leave 			
	Return 			
	Sleep 			

Set Program Schedule

To customize your program schedule, follow these steps

Weekday:

1. Select **HEAT** or **COOL** from the system switch.
Note: You have to program heat and cool each separately.
2. Press **MENU**
3. Press **SET SCHED**. Note: Monday-Friday is displayed and the **WAKE** icon is shown. You are now programming the wake time period for the weekday setting.
4. Time is flashing. Use the or key to make your time selection for the weekday **WAKE** time period.
5. Press **NEXT STEP**
6. The setpoint temperature is flashing. Use the or key to make your setpoint selection for the weekday wake period.
7. Press **NEXT STEP**
8. Repeat steps 4 through 7 for weekday **LEAVE** time period, for weekday **RETURN** time period, and for weekday **SLEEP** time period.

Saturday:

9. Repeat steps 4 through 7 for Saturday **WAKE** time period, for Saturday **LEAVE** time period, for Saturday **RETURN** time period, and for Saturday **SLEEP** time period.

Sunday:

10. Repeat steps 4 through 7 for Sunday **WAKE** time period, for Sunday **LEAVE** time period, for Sunday **RETURN** time period, and for Sunday **SLEEP** time period.

Filter Change Reminder

If your installing contractor has configured the thermostat to remind you when the air filter needs changed, you will see **FILT** in the display when your air filter needs changed. **FILT** will be shown in the display after your system has run long enough to require an air filter change.

Resetting the filter change reminder: When **FILT** reminder is displayed, you should change your air filter and reset the reminder by holding down the second button from the top left side of the thermostat for 3 seconds.

Hold down for 3 seconds, to reset filter reminder.



Temporary and Permanent Hold Feature

Temporary hold: The thermostat will display **HOLD** and **RUN SCHED** on the left of your screen when you press the **+** or **-** key. If you do nothing, the temperature will remain at this setpoint temporarily until the next program period begins. Your program setpoint will then replace your temporary setpoint.

Permanent hold: If you press **HOLD**, you will see **HOLD** appear below the setpoint temperature in the display. The thermostat will now permanently stay at this setpoint and can be adjusted using the **+** or **-** keys.

To return to program: Press **RUN SCHED** to exit either temporary or permanent hold.

Specifications

The display range of temperature	41°F to 95°F (5°C to 35°C)
The control range of temperature	44°F to 90°F (7°C to 32°C)
Load rating	1 amp per terminal, 1.5 amp maximum all terminals combined
Display accuracy	± 1°F
Swing (cycle rate or differential)	Heating is adjustable from 0.2°F to 2.0°F Cooling is adjustable from 0.2°F to 2.0°F
Power source	18 to 30 VAC, NEC Class II, 50/60 Hz for hardwire (common wire) Battery power from 2 AA Alkaline Batteries
Operating ambient	32° to +105° (0° to +41°C)
Operating humidity	90% non-condensing maximum
Dimensions of thermostat	4.7"W x 4.4"H x 0.8"D