

Aqua-Pure[®]

Installation and Operating Instructions For AP Full Flow Drinking Water System Model: 3MFF100

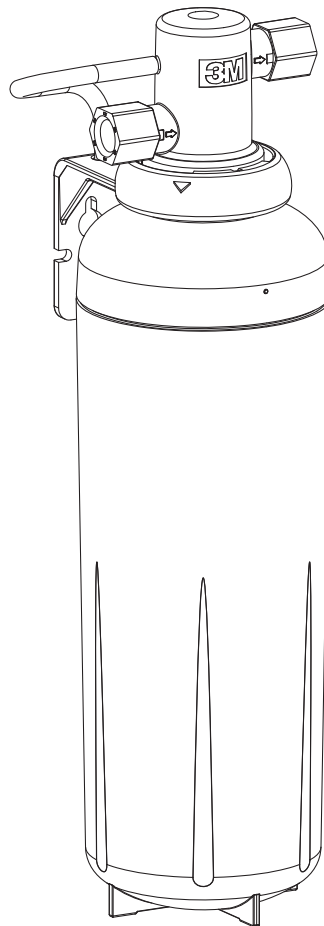

System tested and Certified by NSF International against NSF/ANSI Standard 42 and 53 for the reduction of the claims specified on the Performance Data Sheet and against CSA B483.1.

Installer: Please leave manual with homeowner.



SAFETY INFORMATION

Read, understand, and follow all safety information contained in these instructions prior to installation and use of this Full Flow Drinking Water System Model 3MFF100. Retain these instructions for future reference.

Intended use:

The Full Flow Drinking Water System is intended for use in filtering potable water in homes and has not been evaluated for other uses. Model 3MFF100 is installed at the point of use and typically installed under a sink. System must be installed as specified in the installation instructions by a qualified professional.

EXPLANATION OF SIGNAL WORD CONSEQUENCES	
 WARNING	Indicates a potentially hazardous situation, which, if not avoided, could result in death or serious injury and/or property damage.
CAUTION	Indicates a potentially hazardous situation, which, if not avoided, may result in property damage.

⚠ WARNING	
To reduce the risk associated with choking:	
<ul style="list-style-type: none">• Do not allow children under 3 years of age to have access to small parts during the installation of this product.	
To reduce the risk associated with ingestion of contaminants:	
<ul style="list-style-type: none">• Do not use with water that is microbiologically unsafe or of unknown quality without adequate disinfection before or after the system. Systems certified for cyst reduction may be used on disinfected water that may contain filterable cysts. EPA Establishment #070595-CT-001.	
To reduce the risk associated with a hazardous voltage due to an installer drilling through existing electric wiring or water pipes in the area of installation:	
<ul style="list-style-type: none">• Do not install near electric wiring or piping which may be in the path of a drilling tool when selecting the position to mount the filter bracket.	

CAUTION	
To reduce the risk associated with property damage due to water leakage:	
<ul style="list-style-type: none">• Read and follow Use Instructions before installation and use of this system.• Installation and use MUST comply with all state and local plumbing codes.• Protect filter from freezing, remove replacement filter when temperatures are expected to drop below 40°F (4.4°C).• Do not install systems in areas where ambient temperatures may go above 110°F (43.3°C).• Do not install on hot water supply lines. The maximum operating water temperature of this filter system is 100°F (37.8°C).• Do not install if water pressure exceeds 125 psi (862 kPa). If your water pressure exceeds 80 psi (552 kPa), you must install a pressure limiting valve. Contact a plumbing professional if you are uncertain how to check your water pressure.• Do not install where water hammer conditions may occur. If water hammer conditions exist you must install a water hammer arrester. Contact a plumbing professional if you are uncertain how to check for this condition.• Where a backflow prevention device is installed on a water system, a device for controlling pressure due to thermal expansion must be installed.• Do not use a torch or other high temperature sources near filter system, cartridges, plastic fittings or plastic plumbing.• On plastic fittings, never use pipe sealant or pipe dope. Use PTFE thread tape only, pipe dope properties may deteriorate plastic.• Do not install in direct sunlight or outdoors.• Do not install near water pipes which will be in path of a drilling tool when selecting the position to mount the bracket;• Mount filter in such a position as to prevent it from being struck by other items used in the area of installation (waste baskets, etc.);• Ensure that the location and fasteners will support the weight of the system when installed and full of water.• Ensure all tubing and fittings are secure and free of leaks.• Do not install unit if collet is missing. Contact 3M Purification Inc. if collets are missing from any fittings.• The disposable replacement filter MUST be replaced every 12 months, at the rated capacity or sooner if a noticeable reduction in flow rate occurs.	

IMPORTANT NOTES	
<ul style="list-style-type: none">• Failure to follow instructions will void warranty.• Allow a minimum of 3" (7.6 cm) clear space under filter to facilitate filter change.• Install with the inlet and outlet ports as labeled. Make sure not to reverse connections.	

PRODUCT SPECIFICATIONS

Flow Rate: 2.5 gpm (9.5 lpm)

Pressure: 25 - 125 psi (172 - 862 kPa)

Temperature 40 - 100°F (4.4 - 37.8°C)

Capacity: 6,000 gallons (22,712 liters)

GETTING STARTED

- Installation requires some household tools and additional plumbing components.

Parts and Materials Required for 3MFF100 Undersink Installation (Included):

1. Filter Head Assembly
2. Filter

Items Required (not included):

- Adjustable wrench
- Cordless drill
- Phillips head screwdriver
- Razor knife or tube cutter
- PTFE Tape
- Additional installation parts will be required

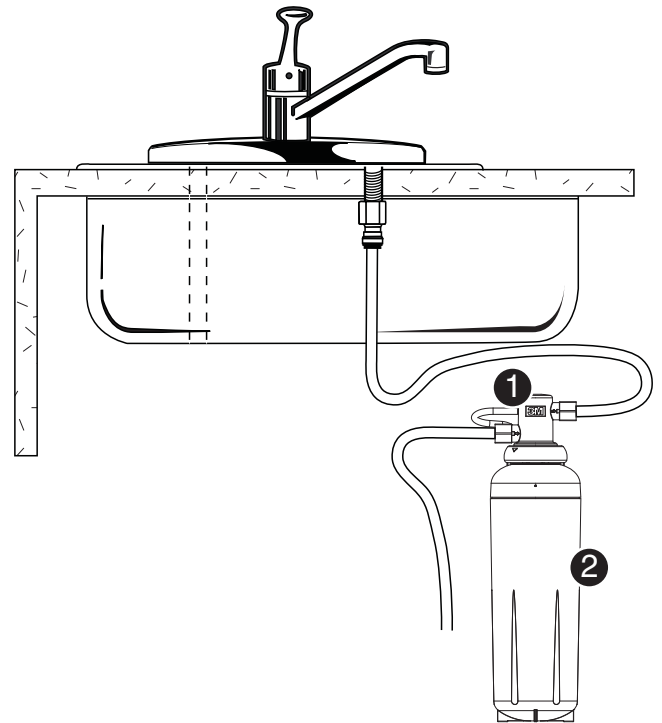

Figure 1

IMPORTANT INSTALLATION INSTRUCTIONS

The following installation instructions described are based on copper plumbing with 3/8" compression fittings. Additional fittings may be required to connect to cold water supply.

1. Open faucet and turn off cold water supply to relieve pressure.
2. Select and mark a location under the sink that allows access for filter change. You will be connecting to the existing line with 3/8" tubing and various fittings not supplied with this filter assembly.

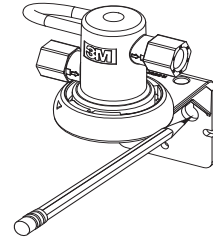

Figure 2

3. Using filter head assembly as a guide, fasten filter head assembly to wall with fasteners. (See Figure 2)

Allow 3" clearance from bottom of replacement filter for ease of removal.

4. Place a basin or a towel under the cold water supply valve. Remove the cold side riser tubing between your cold water supply valve to your primary faucet connection.
5. Install faucet adapter fitting (not included) to faucet stem. This should be a snug fit. Do not overtighten. (See Figure 3) Ensure the black gasket is inserted into the faucet adapter prior to assembly.



Figure 3

6. Install 3/8 NPT Fittings (Not Included) into filter head using PTFE Tape. Do not overtighten.
7. Determine length of 3/8" tubing (not included) required from filter head outlet to faucet adapter by holding tubing in place ensuring it is of appropriate length. Do not kink tubing as this will impede water flow. If necessary, loop tubing around to avoid it being kinked. Cut tubing straight with a razor knife. (See Figure 4)

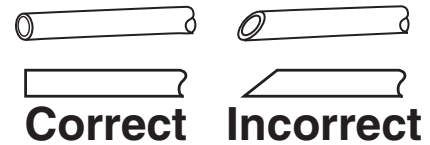

Figure 4

8. Insert 3/8" tubing from faucet adapter fitting into the filter head OUTLET fitting as shown in Figure 5.
9. Determine length of 3/8" tubing (not included) required from filter head inlet to cold water supply valve by holding tubing in place ensuring it is of appropriate length. Do not kink tubing as this will impede water flow. If necessary, loop tubing around to avoid it being kinked. Cut tubing straight with a razor knife. (See Figure 4)

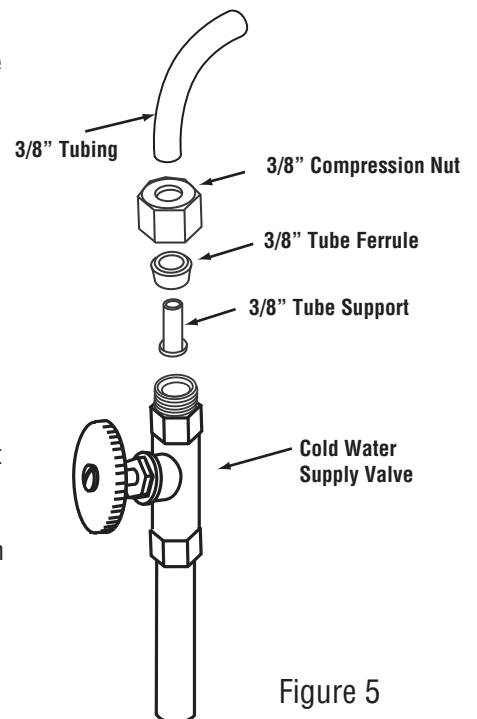

Figure 5

10. Using a tube ferrule, compression nut and tube support (not included), slide nut and ferrule over 3/8" tubing, insert tube support and connect to the cold water supply valve. (See Figure 5) Insert other end into filter INLET fitting as shown in Figure 1.

11. Remove sanitary protective cap from filter. Ensure both o-rings are present on the filter and are seated into grooves; moisten o-rings with water. DO NOT use any petroleum products to lubricate the o-rings.

Note: White tube from head is a filter vent tube outlet. DO NOT remove, kink or obstruct white tube.

IMPORTANT NOTES

- Allow a minimum of 3" (7.6 cm) clear space under the system to facilitate filter changes.
- All components should be accessible and have a sufficient amount of clearance on all sides of the system to facilitate servicing.

12. Align lugs of filter with head assembly and insert filter into head assembly. Turn filter to the right (clockwise) until it stops (about 1/4 turn). The filter is now installed. (See Figure 6)
13. Turn on cold water supply valve and open faucet to flush air from the system. Run water for a minimum of 4 gallons (approximately 2 minutes) to flush system.
14. Close the faucet. The system is now ready for use. System is now under pressure and can be inspected for leaks. Repair any leaks as needed before continuing.

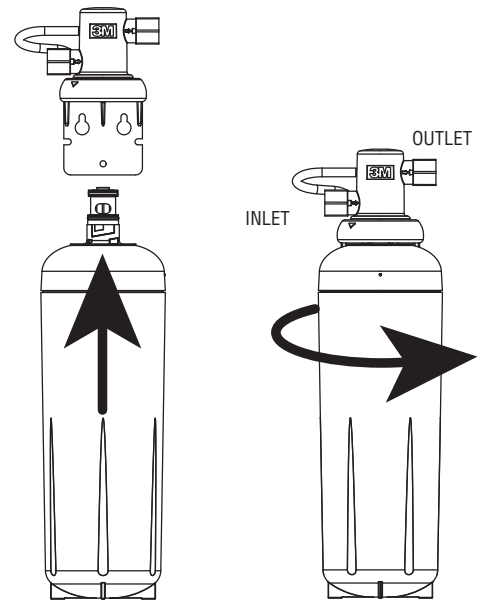

Figure 6

FILTER REPLACEMENT INSTRUCTIONS

CAUTION

To reduce the risk associated with property damage due to water leakage:

- The disposable replacement filter **must** be replaced every twelve (12) months, at the rated capacity or sooner if a noticeable reduction in flow rate occurs.

1. Place towel under filter to collect any residual water during replacement filter change-out.
2. Grasp filter and turn to the left (counterclockwise) until filter comes to a complete stop (water automatically turns off). Water may leak momentarily from vent tube. This is normal. Gently pull filter downward to remove.
3. Remove sanitary protective cap from new replacement filter.
4. Ensure both o-rings are present on the replacement filter and are seated into grooves; moisten o-rings with water. DO NOT use any petroleum products to lubricate the o-rings.
5. Insert replacement filter into filter head assembly. Turn replacement filter one quarter turn to the right (clockwise) until it stops. When fully engaged, the top surface of the filter will be flush with the bottom of the filter head assembly. (See Figure 6)
6. Open faucet and run water for a minimum of 4 gallons (approximately 2 minutes). While system is flushing, check for leaks. Repair any leaks as needed before continuing.

Close filter system faucet. System is now under pressure and can be inspected for leaks. Repair any leaks as needed before continuing. The system is now ready for use.

TROUBLESHOOTING GUIDE

Water Leaks at Push-In Connections:

Push tubing in as far as it will go. If leaking continues, shut off water at the cold water supply valve and remove water line by pushing in on the connector collar while pulling the tubing away. Inspect tubing for cracks and scratches. If tubing is cracked or scratched, simply cut that portion away and reinsert tubing into push-in fitting.

Make sure tubing is cut straight. If not, recut correctly. Please refer to Figure 4.

If water leaks, please verify that the o-rings are properly seated in their grooves.

Water Does Not Flow From The Faucet:

Check to see if the main water line valve is open, allowing water to flow to the filter. Make sure the connections are not reversed.

Water Appears Cloudy or Air Comes Out of the Faucet:

Flush 4 gallons through system before use (approximately 2 minutes).

LIMITED WARRANTY

3M Purification Inc. warrants this Product will be free from defects in material and manufacture for one (1) year from the date of purchase. This warranty does not cover failures resulting from abuse, misuse, alteration or damage not caused by 3M Purification Inc. or failure to follow installation and use instructions. No warranty is given as to the service life of any filter cartridge or membrane as it will vary with local water conditions and water consumption. **3M PURIFICATION INC. MAKES NO OTHER WARRANTIES OR CONDITIONS, EXPRESS OR IMPLIED, INCLUDING, BUT NOT LIMITED TO, ANY IMPLIED WARRANTY OR CONDITION OF MERCHANTABILITY OR FITNESS FOR A PARTICULAR PURPOSE OR ANY IMPLIED WARRANTY OR CONDITION ARISING OUT OF A COURSE OF DEALING, CUSTOMER OR USAGE OF TRADE.** If the Product fails to satisfy this Limited Warranty during the warranty period, 3M Purification Inc. will, at 3M Purification Inc.'s option, replace the Product or refund your Product purchase price. This warranty does not cover labor. **The remedy stated in this paragraph is Customer's sole remedy and 3M Purification Inc.'s exclusive obligation.**

This warranty gives you specific legal rights, and you may have other rights which may vary from state to state, or country to country. For any warranty questions, please call 1-800-222-7880 or mail your request to: Warranty Claims, 3M Purification Inc., 400 Research Parkway, Meriden, CT 06450. Proof of purchase (original sales receipt) must accompany the warranty claim, along with a complete description of the Product, model number and alleged defect.

Limitation of Liability. 3M Purification Inc. will not be liable for any loss or damage arising from this 3M Purification Inc. product, whether direct, indirect, special, incidental, or consequential, regardless of the legal theory asserted, including warranty, contract, negligence or strict liability. Some states and countries do not allow the exclusion or limitation of incidental or consequential damages, so the above limitation or exclusion may not apply to you.



3M Purification Inc.
400 Research Parkway
Meriden, CT 06450, U.S.A.
Tel (800) 222-7880
(203) 237-5541
Fax (203) 238-8701
www.3mpurification.com
www.aquapure.com

3M is a trademark of 3M Company.
Aqua-Pure is a trademark of 3M Company used under license.
NSF is a trademark of NSF International.
© 2011 3M Company. All rights reserved.
Please recycle. Printed in U.S.A.
INSTR2214 1011