

# Installation Manual

# ZBS

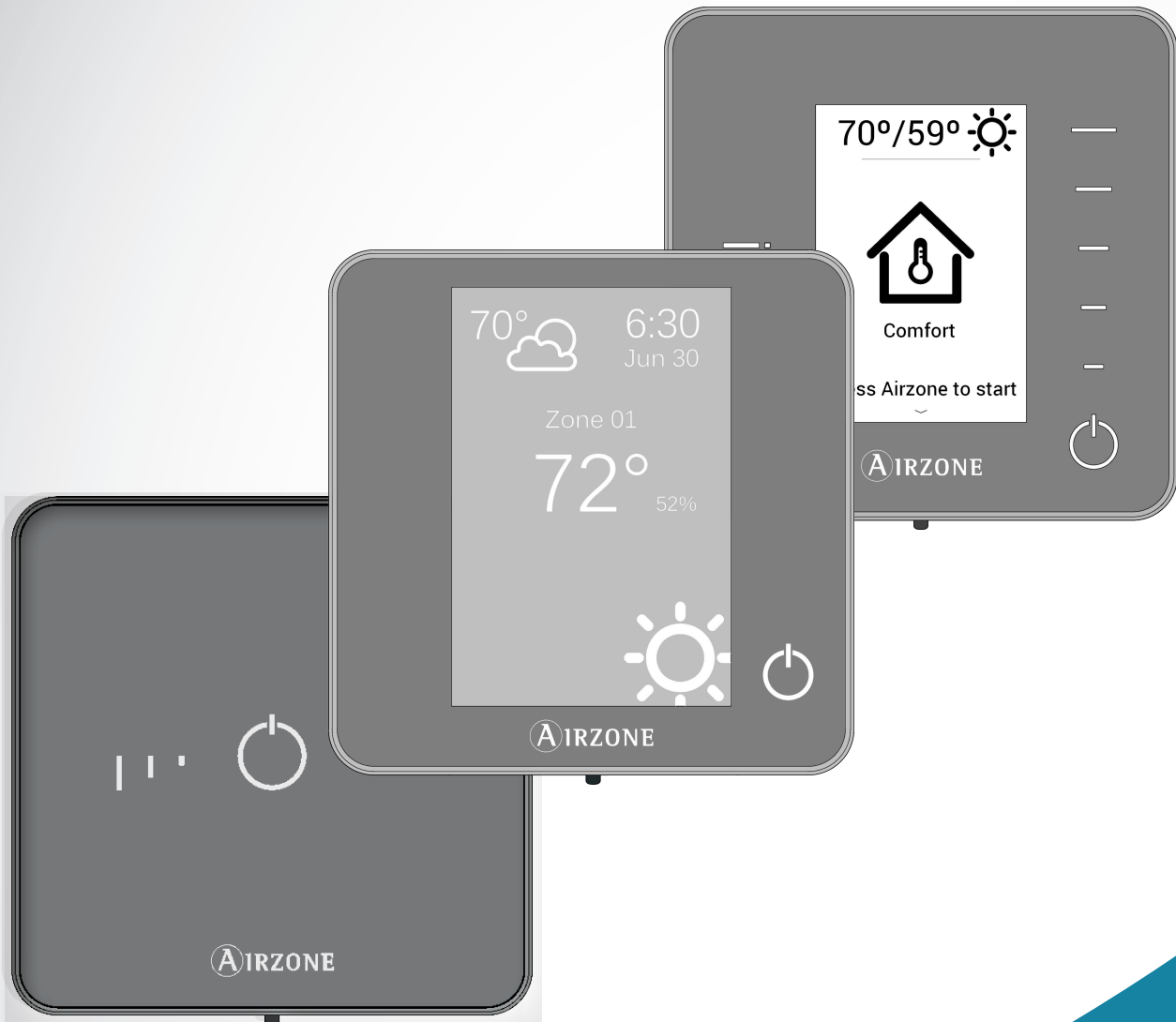

Zone module | Module zone | Módulo de zona

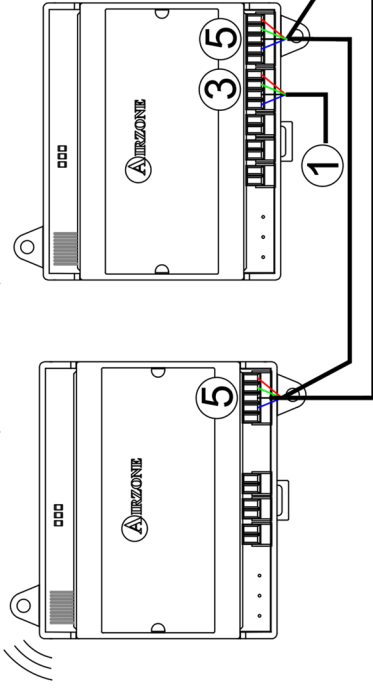

Intelligent round damper | Registre motorisée intelligent | Compuerta motorizada inteligente

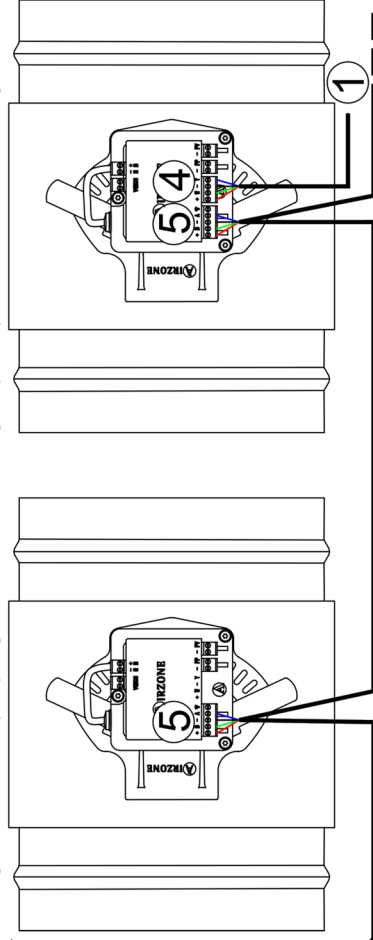

Radiant zone module | Module de zone rayonnant | Módulo de zona radiante

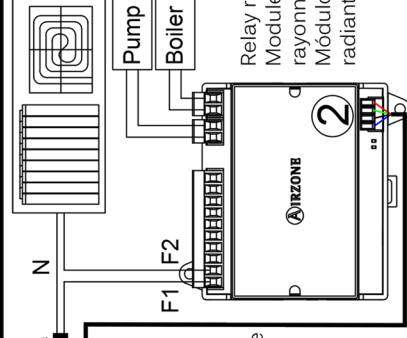
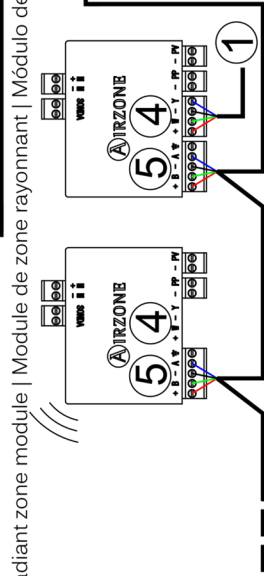

Relay radiant heat control module  
Module de contrôle pour chauffage  
rayonnant par relais  
Módulo de control de calefacción  
radiante mediante relés

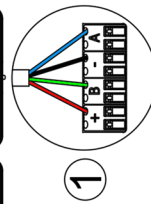
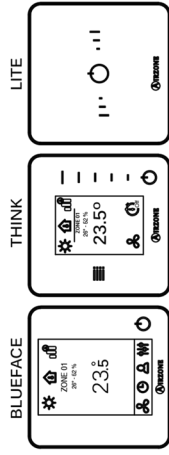
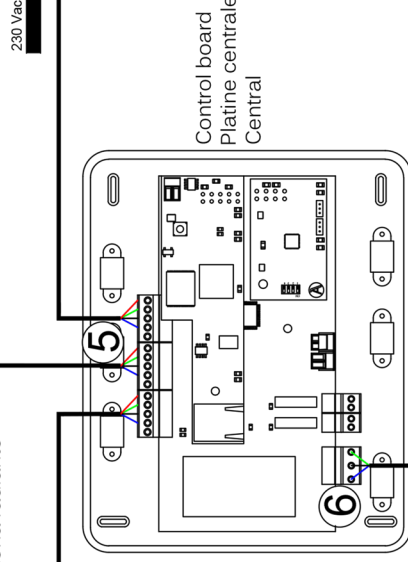

2 x 0.22 + 2 x 0.5 mm<sup>2</sup>

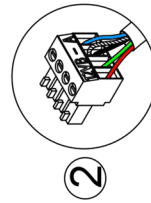

2 x 0.22 + 2 x 0.5 mm<sup>2</sup>

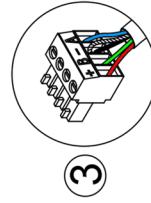

2 x 0.22 + 2 x 0.5 mm<sup>2</sup>

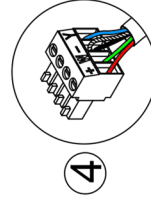

2 x 0.22 + 2 x 0.5 mm<sup>2</sup>

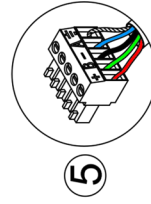

2 x 0.22 + 2 x 0.5 mm<sup>2</sup>

- A Blue | Bleu | Azul
- Black | Noir | Negro
- B Green | Vert | Verde
- + Red | Rouge | Rojo

- A Y Blue | Bleu | Azul
- Shield | Tresse de blindage | Malla
- B W Green | Vert | Verde
- + 12V Red | Rouge | Rojo

- A Blue | Bleu | Azul
- Black | Noir | Negro
- B Green | Vert | Verde
- + Red | Rouge | Rojo
- Shield | Tresse de blindage | Malla

- N Neutral | Neutre | Neutro
- L Phase | Phase | Fase
- Ground | Terre | Tierra

## TABLE OF CONTENTS

Precautions and Environmental Policy .....	5
Precautions.....	5
Environmental policy .....	5
System Elements .....	6
Control Board (AZZBSR2MEL) .....	6
Wired/Wireless Intelligent Round Damper (AZZBSDAMPERxx [C/R]).....	6
Wired/Wireless Only Radiant Zone Module (AZZBSZMRAD [C/R]) .....	6
Wired/Wireless Zone Module With XXX Communication (AZZBSZMxxx [C/R]) .....	7
Relay Radiant Heat Control Module (AZZBS5OUTPUTS).....	7
Blueface Principal Controller (AZZBSBLUEFACEC) .....	7
Wired/Wireless Think Controller (AZZBSTHINK [C/R]) .....	8
Wired/Wireless Lite Controller (AZZBSLITE [C/R]).....	8
Airzone Communication Gateway (AZZBSGT xxx).....	8
Airzone Cloud Ethernet/Wifi Webserver (AZZBSWSCLOUD [C/R]) .....	9
Bacnet Integration Gateway (AZZBSBACNETG) .....	9
Lutron Integration Gateway (AZZBSLUTRONG).....	9
10 KOHM NTC Thermistor (AZZBS10KPROBE) .....	10
Additional 12 V Power Supply (AZZBSPOWER) .....	10
General Requirements.....	11
Introduction .....	13
System installation.....	13
Assembly and connection.....	15
Control Board (AZZBSR2MEL) .....	15
Assembly .....	15
Connection .....	15
Wired/Wireless Intelligent Round Damper (AZZBSDAMPERxx [C/R]).....	18
Assembly .....	18
Connection .....	18
Flow regulation .....	19
Wired/Wireless Only Radiant Zone Module (AZZBSZMRAD [C/R]) .....	20
Assembly .....	20
Connection .....	21
Wired/Wireless zone module with XXX communication (AZZBSZM xxx [C/R]) .....	22
Assembly .....	22
Connection .....	22
Relay Radiant Heat Control Module (AZZBS5OUTPUTS).....	23
Assembly .....	23
Connection .....	24
Wired Controllers (AZZBSBLUEFACEC / AZZBSTHINKC / AZZBSLITEC) .....	25
Assembly .....	25
Connection .....	25
Wireless Controllers (AZZBSTHINKR / AZZBSLITER) .....	25
Assembly .....	25
Changing batteries.....	25

Ethernet/WiFi Cloud Webserver (AZZBSWSCLOUD [C/R]).....	26
Assembly .....	27
Connection .....	27
Configuration.....	27
BACnet Integration Gateway (AZZBSBACNETG).....	28
Assembly .....	28
Configuration.....	28
Lutron Integration Gateway (AZZBSLUTRONG).....	28
Assembly .....	29
Configuration.....	29
Assembly and connection evaluation.....	29
Secondary zones settings.....	29
Initial Setup .....	30
Blueface and Think Controllers.....	30
Lite Controllers .....	33
Lite controller reset.....	34
Initial configuration evaluation .....	34
User and zone settings.....	35
Blueface Controller .....	35
User Settings .....	35
Zone Settings.....	35
Think Controller .....	36
Setting Parameters.....	36
Advanced settings .....	39
Advanced settings – Blueface controller.....	39
System settings .....	39
Zone settings .....	41
Advanced settings – Think controller.....	42
Self-diagnose.....	43
Control Board (AZZBSR2MEL) .....	43
Wired/Wireless Intelligent Round Damper And Wired/Wireless Only Radiant Zone Module (AZZBSDAMPERxxx [C/R] and AZZBSZMRAD [C/R]) .....	44
Wired/Wireless Zone Module With Xxx Communication (AZZBSZM xxx [C/R]).....	44
Relay Radiant Heat Control Module (AZZBS5OUTPUTS).....	45
Blueface and Think controllers (AZZBSBLUEFACEC / AZZBSTHINK [C/R]).....	46
Blueface and Think Controller Warnings.....	46
Blueface and Think Controllers errors.....	46
Lite Controllers (AZZBSLITE [C/R]).....	53
Communication Gateways (AZZBSGTxxx) .....	56
Ethernet/WiFi Cloud Webserver (AZZBSWSCLOUD [C/R]).....	56
Bacnet Integration Gateway (AZZBSBACNETG) .....	57
Lutron Integration Gateway (AZZBSLUTRONG).....	57
Navigation Trees.....	58
Blueface Controller Navigation Tree .....	58
Think Controller Navigation Tree.....	59

## PRECAUTIONS AND ENVIRONMENTAL POLICY

### PRECAUTIONS

For your security, and to protect the devices, follow these instructions:

- Do not manipulate the system with wet or damp hands.
- Disconnect the power supply before making any connections.
- Take care not to cause a short circuit in any of the system connections.

### ENVIRONMENTAL POLICY



Do not dispose of this equipment in the household waste. Electrical and electronic equipment contain substances that may damage the environment if they are not handled appropriately. The symbol of a crossed-out waste bin indicates that electrical equipment should be collected separately from other urban waste. For correct environmental management, it must be taken to the collection centers provided for this purpose, at the end of its useful life.

The equipment components may be recycled. Act in accordance with current regulations on environmental protection.

If you replace it with other equipment, you must return it to the distributor or take it to a specialized collection center.

Those breaking the law or by-laws will be subject to such fines and measures as are laid down in environmental protection legislation.

## SYSTEM ELEMENTS

### CONTROL BOARD (AZZBSR2MEL)

Electronic board with a communication gateway (see section *Communication Gateway AZZBSGTxxx* for more information), which manages all wired and wireless devices in the system. Externally powered at 110/230 VAC. Wall mounted.

Features:

- Controls the status of the controllers (up to 10 zones).
- Controls the proportionality and the minimum air supply of the dampers.
- Control of auxiliary heat (up to two stages).
- Management of the control gateway.
- Communication with units of integral control of the installation.
- Communications with other external control systems through integration bus.

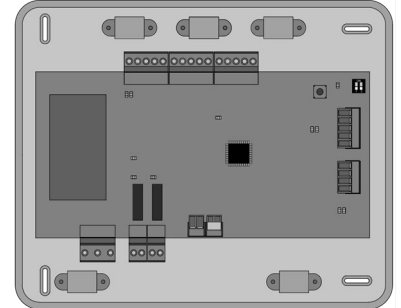

**Important:** The Airzone system is not compatible with electric duct heaters, it may result in system malfunction and/or fire.

### WIRED/WIRELESS INTELLIGENT ROUND DAMPER (AZZBSDAMPERXX [C/R])

#### Damper with actuator

Damper with actuator of 6, 8, 10 or 12 inches diameter. Powered with 12 VDC by the zone module.

#### Wired/wireless damper zone module

Local control module for controlling the operation of the damper. Wired/wireless communication with zone controller. Powered through system Airzone connection bus.

Features:

- Input for detection of open windows.
- Input for detection of presence.
- Probe input.

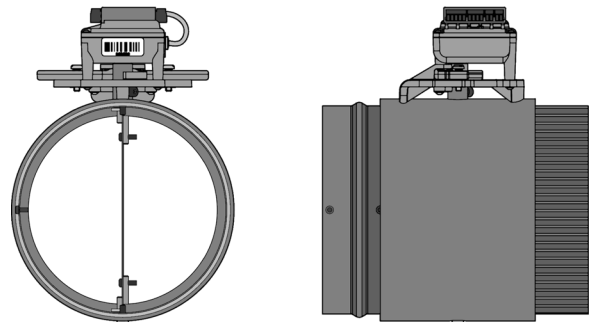

### WIRED/WIRELESS ONLY RADIANT ZONE MODULE (AZZBSZMRAD [C/R])

Local control module for controlling radiant elements. Wired/wireless communication with zone controller. Powered through system Airzone connection bus.

Features:

- Input for detection of open windows.
- Input for detection of presence.
- Probe input.

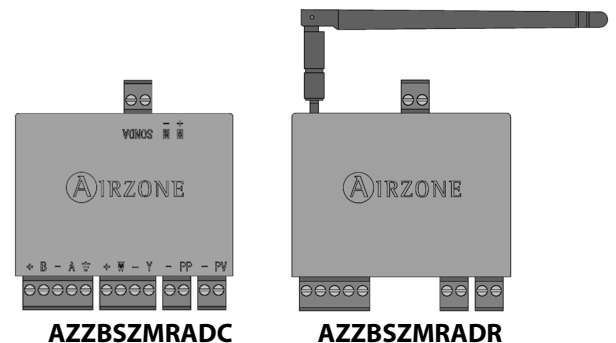

## WIRED/WIRELESS ZONE MODULE WITH XXX COMMUNICATION (AZZBSZMXXX [C/R])

Module for controlling individual direct expansion units through Airzone communication gateway (see section *Communication Gateway AZZBSGTxxx* for more information). Wired/wireless communications with zone controller. Powered through system Airzone connection bus. Mounted on DIN rail or on wall.

Features:

- Input for detection of open windows.
- Input for detection of presence.
- Probe input.

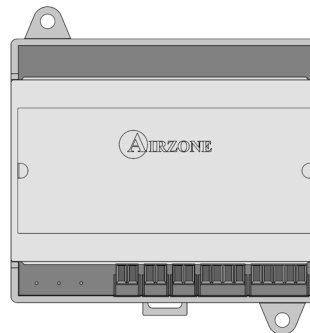

AZZBSZMxxxC

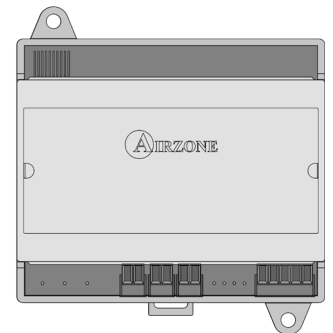

AZZBSZMxxxR

## RELAY RADIANT HEAT CONTROL MODULE (AZZBS5OUTPUTS)

Control module of radiant heat for heating stages. Communications via Airzone connection bus of control board. Powered by control board. Mounted on DIN rail.

Features:

- Control up to 5 zones of heating elements by means of free-voltage relays.
- Demand Relay of Pump.
- Demand Relay of Boiler.
- Identified by means of a micro-switch.

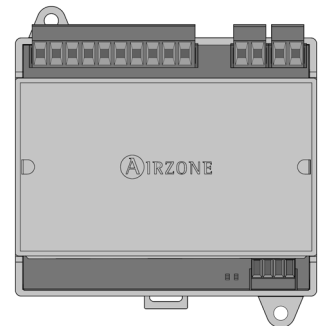

**Important:** The Airzone system is not compatible with electric duct heaters, it may result in system malfunction and/or fire.

## BLUEFACE PRINCIPAL CONTROLLER (AZZBSBLUEFACEC)

Color graphic interface with capacitive screen for controlling zones in Airzone systems. Powered by zone module. Finished in steel and glass.

Features:

- Available in English, French and Spanish.
- Control of temperature, operation mode (main controller), user mode (main controller).
- Automatic or manual fan speed adjustment (depends on installation).
- Room temperature and relative humidity measurement of the zone.
- Configuration stages control (air, radiant or air+radiant).
- Timer function.
- Temperature, user mode and on/off time schedules.
- Remote access to other zones of the system.
- Weather forecast (optional, requires Airzone Cloud Webserver).



### WIRED/WIRELESS THINK CONTROLLER (AZZBSTHINK [C/R])

Graphic interface with low-energy e-ink screen and capacitive buttons for controlling zones in Airzone systems. Wired/wireless communications. Finished in steel and glass. Powered by zone module (wired) or by battery button CR2450 (wireless).

Features:

- Available in English, French and Spanish.
- Control of temperature, operation mode (main controller), user mode (main controller).
- Automatic or manual fan speed adjustment (depends on installation).
- Room temperature and relative humidity measurement of the zone.
- Configuration stages control (air, radiant or air+radiant).
- Timer function.
- Weather forecast (optional, requires Airzone Cloud Webserver).



### WIRED/WIRELESS LITE CONTROLLER (AZZBSLITE [C/R])

Controller with capacitive buttons for controlling the temperature of the zones in Airzone systems. Wired/wireless communication. Powered by zone module (wired) or by battery button CR2450 (wireless).

Features:

- On/off of the zone.
- Set-point temperature control (accuracy:  $\pm 1^{\circ}\text{C}$  /  $2^{\circ}\text{F}$ , up to a limit of  $\pm 3^{\circ}\text{C}$  /  $6^{\circ}\text{F}$ ).
- Room temperature and relative humidity reading.



### AIRZONE COMMUNICATION GATEWAY (AZZBSGT XXX)

Element that integrates the functioning of the AC units and Airzone zoning systems, enhancing the performance of the installation:

- ON/OFF of the AC unit depending on the number of zones in demand.
- Automatic mode changeover (Auto, Cooling, Heating or Dry) from main controller.
- Automatic fan speed selection based on the number of zones on demand.
- Set-point temperature adjustment based on the set-point temperatures of the zone controllers of the system.

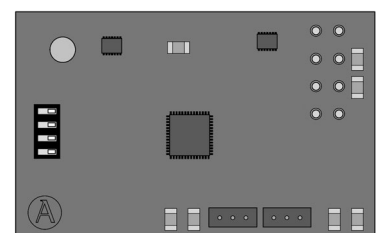



## AIRZONE CLOUD ETHERNET/WIFI WEBSERVER (AZZBSWSCLOUD [C/R])

Webserver for controlling Airzone systems through Airzone Cloud platform. Accessible via web browser or App (available for IOS and Android). Connected to router via Ethernet (AZZBSWSCLOUDC) or WiFi (AZZBSWSCLOUDR). Powered through automation bus.

Functionalities:

- Control of up to 32 systems.
- Configuration and control of zone parameters (Room and set-point temp., operating mode, etc.) and system parameters via Airzone Cloud.
- Temperature and operating mode time schedules.
- Multi-user and multi-session.
- External control through Airzone Cloud platform (app and web browser).
- Remote updates of the Webserver firmware and the systems connected to it.
- Remote error detection and error resolution.

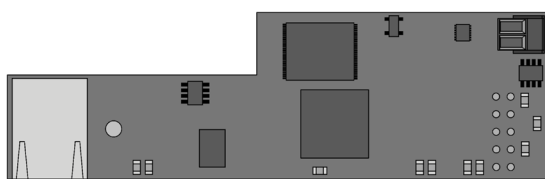

**AZZBSWSCLOUDC**

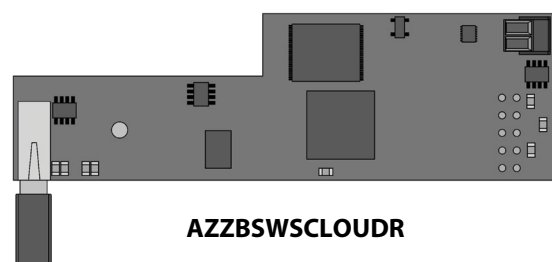

**AZZBSWSCLOUDR**

## BACNET INTEGRATION GATEWAY (AZZBSBACNETG)

Integration gateway for controlling Airzone installations through BACnet platform. Connected to router via Ethernet. Power supplied through the control board automation bus.

Functionalities:

- One BACnet gateway per system.
- Status of window contact and presence contact of each zone.
- Status of the radiant stage of each zone.
- On/Off of each zone.
- Set-point temperature control for each zone.
- Operating mode status.

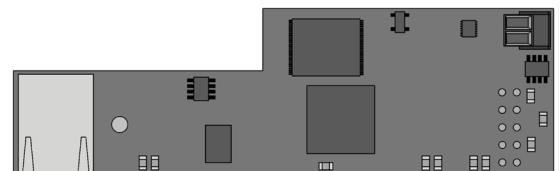

## LUTRON INTEGRATION GATEWAY (AZZBSLUTRONG)

Integration gateway for Lutron control systems on Airzone systems through Lutron HomeWorks QS Processor. Connected via Ethernet. Power supplied through the main control board automation bus.

Features:

- One Airzone-Lutron interface per system.
- Reading/Writing of the room temperature.
- Reading/Writing of the set-point temperature.
- Reading/Writing of the operating mode.
- Reading/Writing of the cooling/heating demand.
- Reading/Writing of the fan speeds.

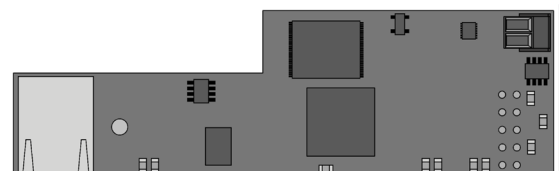

### 10 KOHM NTC THERMISTOR (AZZBS10KPROBE)

Temperature probe in metal sheath.

Features:

- Configurable for remote or distributed sensing.
- Protection probe for air supply.



### ADDITIONAL 12 V POWER SUPPLY (AZZBSPower)

External power supply for Airzone system. DIN rail mounted. 110/230 Vac power supply:

- Power supply for more than 6 zone modules via Blueface or 10 zone modules without Blueface. These values can be altered depending on the separation distance among them.

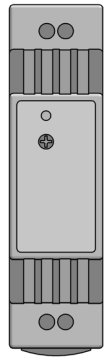

## GENERAL REQUIREMENTS

Strictly follow the directions outlined in this manual:

- This system must be installed by a qualified technician.
- Verify that the units to be controlled have been installed according to the manufacturer's requirements and operate correctly before installing the Airzone System.
- Locate and connect all the devices of the installation in accordance with the electronic regulations in force.
- Verify that the air conditioning installation to be controlled is in accordance with the regulations in force.
- To install the flexible duct, follow the local recommendations for its ubication and isolation of the ducts to the damper. Perform a cut along the isolated area to maintain the actuator of the damper outside it. Once finished, check the tightness of the joints between the damper and the duct.

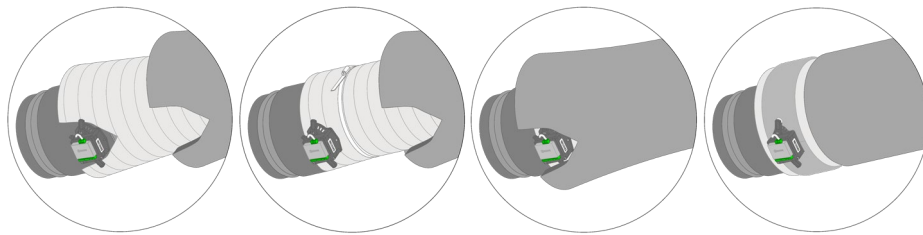

- On zones controlled by wireless controllers, place the dampers and zone modules as close as possible to the wireless controller of the zone.

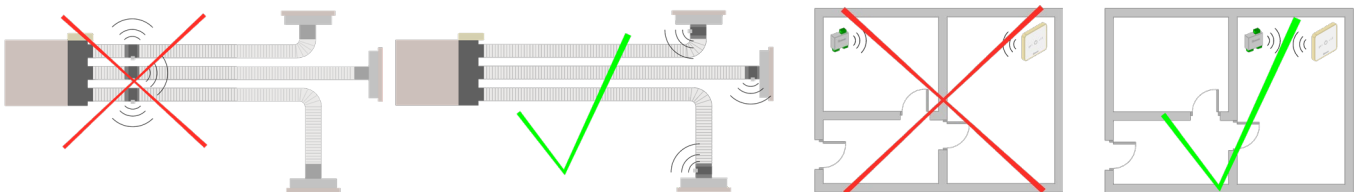

- Follow these recommendations to locate the controllers:

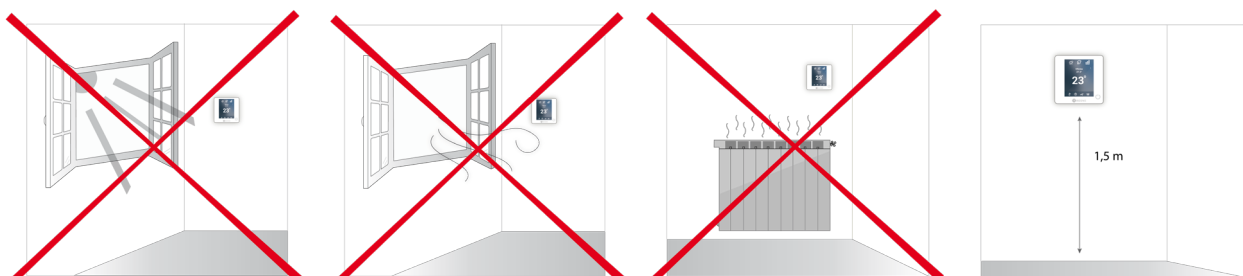

- Make all the connection with total absence of power supply.
- In order to connect the elements of the system, use the cable: shielded twisted pair cable formed by 4 wires: 2x0,22 mm<sup>2</sup> + 2x0,5mm<sup>2</sup> (AWG 20 – 4 wired). **The connection between the control modules must be made in Bus mode.**
- Do not place the system bus close to lines of force, fluorescent lights, LED lamps, motors, etc. It might cause interference on the communications.

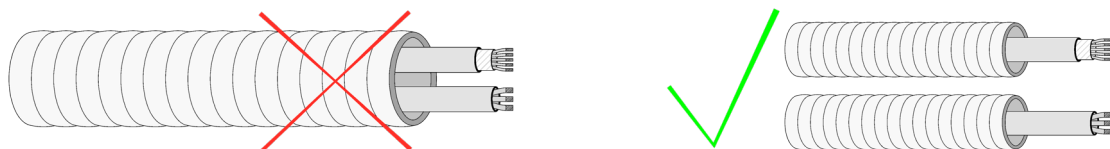

- Respect the connection polarity of each device. A wrong connection may seriously damage the product.
- For elements externally powered at 110 /230 Vac, for the communications, it is only necessary to connect the poles "A" and "B" of the bus.

- For elements externally powered at 110/230 Vac, respect the connection polarity. A wrong grounding may produce electric shocks.
- According to the current local and national regulations, it is mandatory to add a switch (or other element to disconnect the system) to the external supply wiring so that a constant separation between poles is guaranteed. The system will restart automatically if the supply is eventually turned off. **Use an independent circuit from the controlled system for the power supply.**
- Once the Airzone system is configured, verify that the static pressure of the duct system complies with the air distribution network conditions where is installed (check the Manufacturer's Manual of the equipment if you need to modify this parameter).

## INTRODUCTION

Airzone systems enable the management of Main and Zone interfaces. Main controllers enable mode management or user mode and airflow of the system.

- Blueface Main: Mode, User mode icons shown in white color.
- Blueface Zone: Mode, User mode and Speed icons shown in gray color.
- Think Main: Accessing the settings menu, Operation mode and User mode are available.
- Think Zone: Accessing the settings menu, Operation mode and User mode are unavailable.

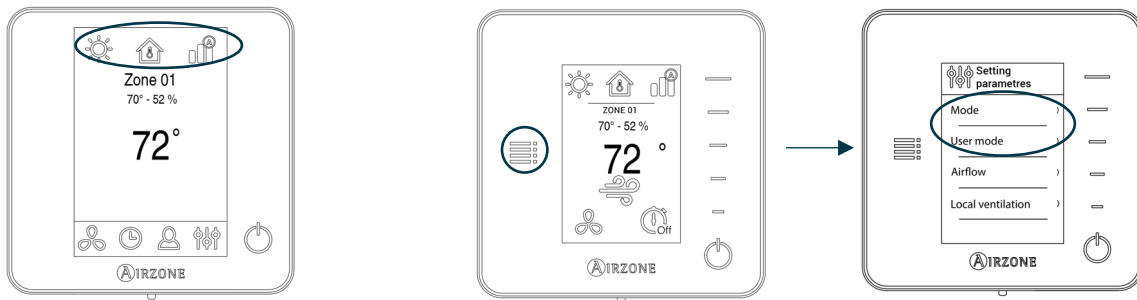

## SYSTEM INSTALLATION

Before performing the Airzone system installation, check:

- The equipment to control has been installed according to the manufacturer's criteria and it works correctly without the Airzone system.
- In direct expansion unit systems, the indoor unit wired controller has been installed.

**Important:** For installations with radiant surfaces only, it is recommended the installation of buffer tanks.

In order to install properly your Airzone system, follow these steps:

1) **Locate all the elements and perform the connection** (See section *Assembly and Connection*).

- **Zone and Control Modules connection with the Airzone ZBS Control board.** Connect the zone modules of the system to any of the 3 Airzone connection bus terminals. Use the proper cable: shielded twisted pair 4 wired:  $2 \times 0.22 \text{ mm}^2 + 2 \times 0.5 \text{ mm}^2$  (AWG 20 – 4 wired). They must be connected by bus. For added security, secure the wires using the turrets.



### WIRELESS OPTION

Place the dampers and zone modules as close as possible to the wireless controller of the zone.

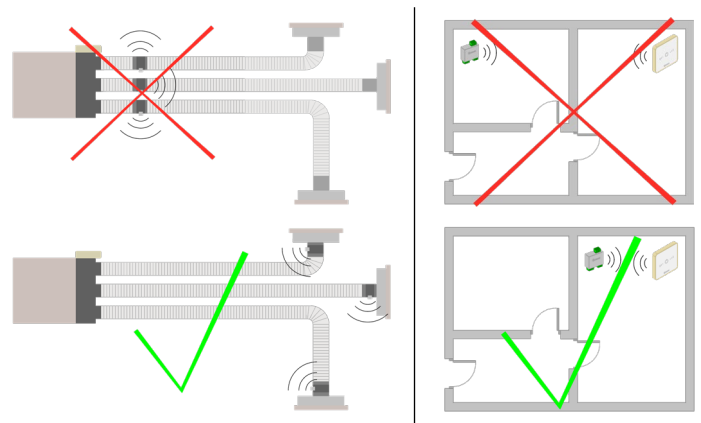

**IMPORTANT:** The maximum number of zone modules connected without their own power supply to the Airzone ZBS control Board is: 6 zone modules connected to Blueface controllers or 10 zone modules connected to Think or Lite controllers. To add more zone modules, it is necessary to install the supplementary power supply unit (Airzone ZBS additional 12V power supply). Every supplementary power supply unit is enough for 6 or 10 modules as stated before.

- **Connecting the controllers.** Connect each controller to the terminal corresponding to its zone module. Use the proper cable: shielded twisted pair 4 wired:  $2 \times 0.22 \text{ mm}^2 + 2 \times 0.5 \text{ mm}^2$  (AWG 20 – 4 wired). In case of Wireless controller, check it has the battery on.
- **Configuration and connection of the relay radiant heat control module.** If you have a relay radiant heat control module, configure the SW2 microswitch depending on the zones to control. Once configured, perform the connection with the radiant elements to control per each relay output of the module.

**Important:** *The Airzone system is not compatible with electric duct heaters, it may result in system malfunction and/or fire.*

- **Connection to the ducted unit** (see section Gateway Connection). It is recommended to install the controller of the unit. For the connection of DIN rail gateways to the control board, use the proper cable: shielded twisted pair 2 wired:  $2 \times 0.22 \text{ mm}^2$  (AWG 24 – 2 wired).
- **Connection of the zone modules with the elements/systems to control (Split, etc.).** (Refer to connection section of each zone module).
- **Webserver Cloud connection or BACnet integration gateway.** Connect your Webserver Cloud or BACnet Gateway to the automation bus of the Control Board (follow the steps shown on the Assembly section).



All Airzone systems must be connected to internet to offer technical support.

It is only necessary to connect **one Webserver Cloud per installation** (control of up to 32 systems), for **BACnet or Lutron integration gateway, one per system.**

- **Auxiliary Heat and other peripherals.** If your system includes auxiliary heat, connect the auxiliary heat relays of the ZBS Control board to the elements to control.

**Important:** *The Airzone system is not compatible with electric duct heaters, it may result in system malfunction and/or fire.*

- **Powering the system.** Use the power input to power at 110 / 230 Vac the control board and any others control elements that require it. To do that, use a  $3 \times 1,5 \text{ mm}^2$  cable (AWG 15 – 3 wired). For added security, secure the wires using the turret.

2) **Check all the assembly and the connection are correct** (see section *Assembly and connection evaluation*).

3) **Configure the system.**

- Configure the secondary modules to associate them to a main controller (see section *Secondary zones settings*).
- Configure all the controllers (see sections *Initial setup* and *Advanced settings*).

4) **Check the correct operation of the system** (See *Initial Configuration Evaluation*).

Access all our technical documents and the self-diagnosis section, check the FAQs, certificates, watch our videos and read our declaration of conformity at:

**myzone.airzoneusa.com**



**Don't forget to download, complete and print the *Commissioning* document available on myzone.airzoneusa.com to place it together with your installation.**

## ASSEMBLY AND CONNECTION

### CONTROL BOARD (AZZBSR2MEL)

#### Assembly

The Airzone control board is supplied in a box to be screwed to the wall (Fig. 1). It should be placed and mounted in accordance with the current electrotechnical regulations.

For the mounting of the control board, follow the following steps:

- Locate the control board close to the unit to be controlled.
- Unscrew the cover securing the back part to the wall.
- Make all the connections and screw the cover again.

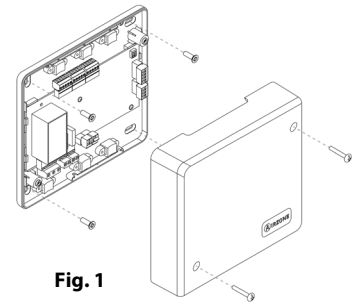

Fig. 1

#### Connection

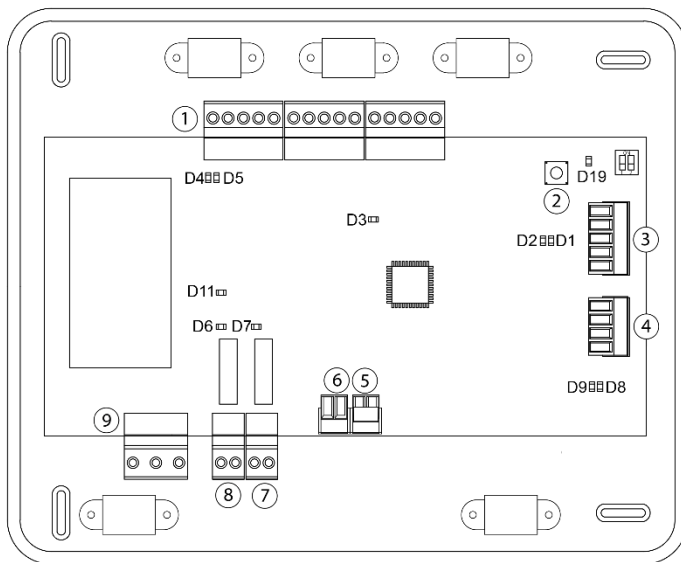

Fig. 2

N°	Description
1	Airzone Connection Bus
2	SW1
3	Automation bus
4	AC unit bus
5	Alarm input (normally closed)
6	Protection temperature probe
7	Auxiliary heat 2nd Stage output
8	Auxiliary heat 1st Stage output
9	Power supply

#### Airzone Connection Bus connectors

The Airzone Connection Bus allows you to connect all the internal components that are independent from the main board to control up to 10 zones. These are the modules that can be connected:

- Wired/Wireless intelligent round damper (AZZBSDAMPERxxx [C/R]).
- Wired/Wireless only radiant zone module (AZZBSZMRAD [C/R]).
- Wired/Wireless zone module with XXX communication (AZZBSZMxxx [C/R]).
- Relay radiant heat control module (AZZBS5OUTPUTS).

It has 3 5-pin terminals to connect the Airzone Connection Bus. Use the proper cable: shielded twisted pair 4 wired:  $2 \times 0.22 \text{ mm}^2 + 2 \times 0.5 \text{ mm}^2$  (AWG 20 – 4 wired). **They must be connected by bus.** Attach the wires with the terminal screws following the color code (Fig. 3). For added security, secure the wires using the turrets (Fig. 4).

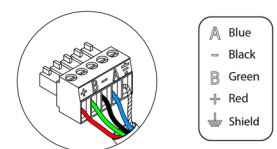

Fig. 3

**Note:** For elements externally powered at 110/230 Vac, it is only necessary to connect the poles "A" and "B" of the bus.

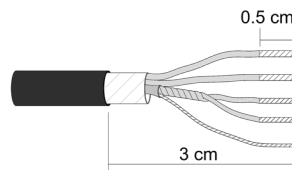
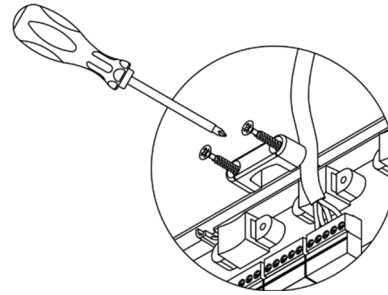

Fig. 4



## SW1

The control board can also connect to Airzone wireless elements. These elements are associated by opening the wireless association module of the Control board. Press on SW1 and wait for the LED 19 to remain red (Fig. 5). The wireless association module will be open for 15 minutes.

**System reset:** If you want to return to factory values, press and hold on SW1 (Fig. 5) until LED D19 stops blinking. Wait 60 seconds until the system restarts before connecting again.

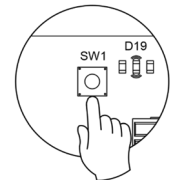

Fig. 5

## Automation bus connector

The automation bus allows you to interconnect multiple systems in order to control them through Airzone control peripherals or to integrate them into a superior control network. The elements to connect to this bus are:

- Ethernet/WiFi Cloud Webserver (AZZBSWSCLOUD [C/R]).
- BACnet Integration Gateway (AZZBSBACNETG).
- Lutron Integration Gateway (AZZBSLUTRONG).



All Airzone systems must be connected to internet to offer technical support.

It is only necessary to connect **one Webserver Cloud per installation** (control of up to 32 systems), for **BACnet or Lutron integration gateway, one per system**.

## AC unit bus connector

The communication gateway (AZZBSGT xxx) connected to the AC unit bus allows you to connect to the AC unit.

## Alarm input

This input closes all the dampers and imposes Stop mode when there is an alert. This input is configured as normally closed. For proper operation of the system, this contact is supplied with a bonding jumper.

## Protection temperature probe connector

It measures the outdoor temperature through an external probe. We recommend the use of this probe when using electromechanical units or NON-Inverter units (when it is necessary to control the return temperature of the units).

## Auxiliary heat outputs

The system includes auxiliary heat, connect the auxiliary heat relays of the ZBS Control board to the elements to control. Control relay specs are  $I_{max}$ : from 1 A to 24-48 V, voltage-free. To control elements of a greater power, it is recommended to use contactors in accordance with the power required.

**Important:** The Airzone system is not compatible with electric duct heaters, it may result in system malfunction and/or fire.



### Power supply connector

This connector powers the control board and all the elements connected to it. Externally powered at 110/230 Vac. It is connected through a 3-pin terminal. Use a  $3 \times 1,5 \text{ mm}^2$  (AWG 15 – 3 wired) cable. Attach the wires with the terminal screws following the color code (Fig. 6). For added security, secure the wires using the turret (Fig. 7).

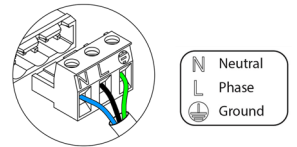

Fig. 6

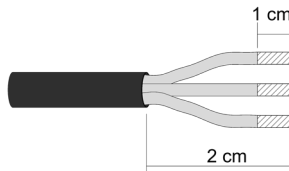
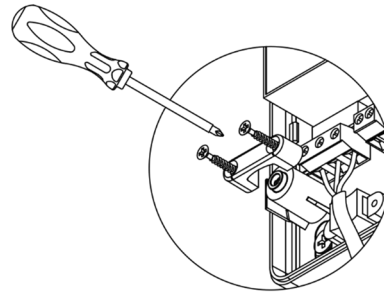

Fig. 7



**Important:** According to the current local and national regulations, it is mandatory to add a switch (or other element to disconnect the system) to the external supply wiring so that a constant separation between poles is guaranteed. The system will restart automatically if the supply is eventually turned off.

**Remember:** Once all the connections are made, make sure you replace the cover properly (Fig. 8).

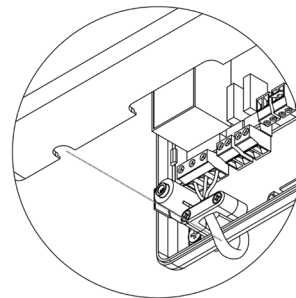
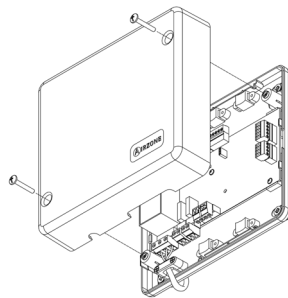

Fig. 8

## WIRED/WIRELESS INTELLIGENT ROUND DAMPER (AZZBSDAMPERXX [C/R])

### Assembly



#### WIRELESS OPTION

Place the dampers as close as possible to the wireless controller of the zone.

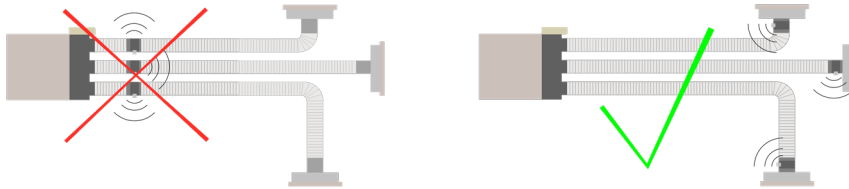

### Connection

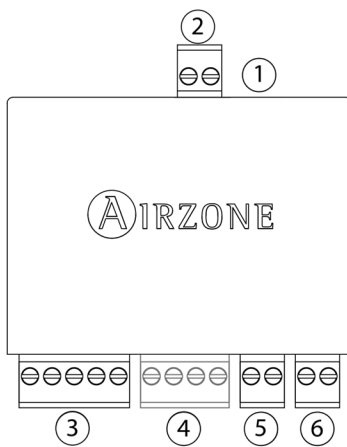

Fig. 9

N°	Meaning
1	Motorized element connector
2	Probe connector
3	Airzone Connection Bus
4	Controller connection (Only AZZBSDAMPERxxC)
5	Presence contact
6	Window contact

**Note:** Use a shielded twisted pair to connect the window contact.

The Intelligent round damper is connected to the Airzone Connection Bus of the control board (Fig. 10).

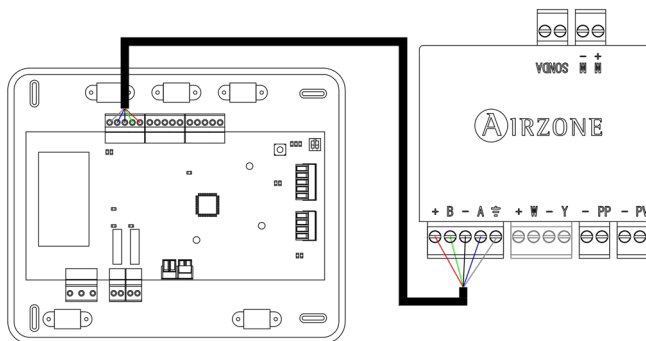

Fig. 10

It has a 5-pin terminal to connect it to the Airzone Connection Bus of the main board. Use the proper cable: shielded twisted pair 4 wired:  $2 \times 0.22 \text{ mm}^2 + 2 \times 0.5 \text{ mm}^2$  (AWG 20 – 4 wired). Attach the wires with the terminal screws following the color code (Fig. 11).

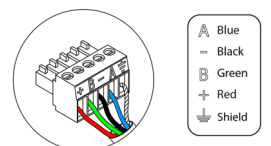

Fig. 11

It has a 4-pin terminal to connect the controller. Use the proper cable: shielded twisted pair 4 wired:  $2 \times 0.22 \text{ mm}^2 + 2 \times 0.5 \text{ mm}^2$  (AWG 20 – 4 wired). Attach the wires with the terminal screws following the color code (Fig. 12).

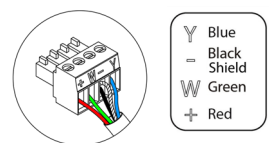

Fig. 12

**Remember:** The maximum separation between the module and the controller is 10 meters.

The zoning module allows you to connect a probe (AZZBS10KPROBE) for remote or distributed temperature reading, depending on how the module is configured:

- **Remote probe:** This function allows you to read the room temperature even if you are not where the controller is located. Connect the probe and configure the module as main module (connected controller). The state and the set-point temperature are set via controller while the probe reads the room temperature.
- **Distributed probe:** This function allows you to control a secondary zone with room temperature reading independent from the main zone. Connect the probe and configure the module as secondary (disconnected controller). The state and the set-point temperature are set via controller while the probe reads the room temperature.

The module has several inputs to control based on the occupancy or if there are open windows.

- **Control by occupancy:** When the occupancy sensor connected to the module indicates that the zone is unoccupied, the system waits for 5 minutes to confirm it is actually empty. After this period of time, the zone is set to Timer Mode and it turns off after 90 minutes.
- **Control by open window:** When the open window sensor connected to the module indicates that a window is open for more than 60 seconds, the control element (actuator/relay) associated with that module closes.

The activation and configuration of these inputs are available in the zone settings menu of the controller (See *Advanced Settings*).

## Flow regulation

The intelligent motorized dampers include a control system that allows to manually set the maximum and minimum opening of each damper.

### Flow adjustment (REG)

The damper offers a maximum opening adjustment which balances the airflow of each damper based on the real needs of the installation. By default, the damper is set at the I position. To adjust it, follow the steps:

1. Turn on and generate demand in all zones to open all the dampers.
2. Turn off the zone/damper to be adjusted.
3. Adjust the maximum opening you want with the REG lever (I/II/III/IV).
4. Turn on the zone and check the flow is correct.

### Minimum Air Setting (A-M)

The damper enables the adjustment of a minimum opening. By default, the damper is set at the "a" position. To adjust it, follow the steps:

1. Turn on and generate demand in all zones to open all the dampers.
2. Adjust the minimum opening you want with the M-A lever (a/b/c/d).
3. Turn on the zone and check the minimum air flow is correct.

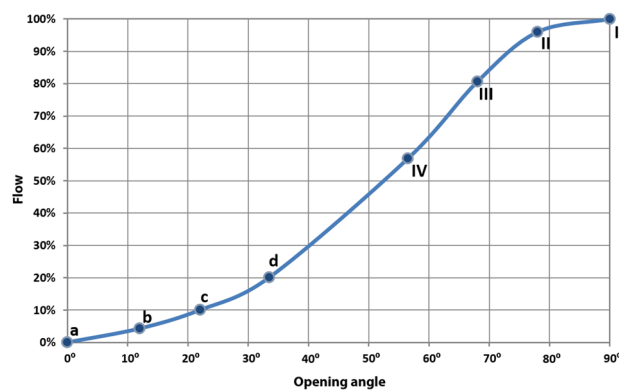
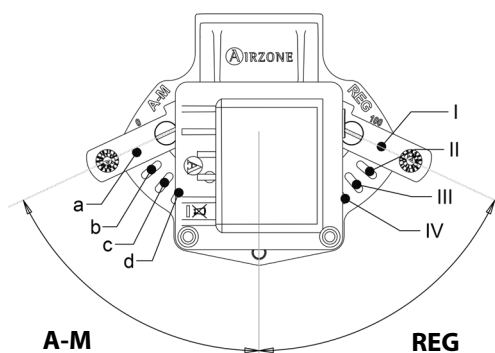

## WIRED/WIRELESS ONLY RADIANT ZONE MODULE (AZZBSZMRAD [C/R])

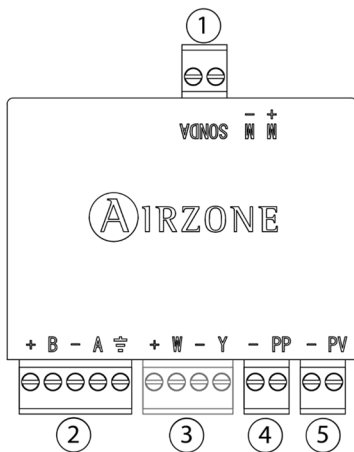

Fig. 13

N°	Meaning
1	Probe connector
2	Airzone connection bus
3	Controller connection ( <i>Only AZZBSZMRADC</i> )
4	Presence contact
5	Window contact

**Note:** Use a shielded twisted pair to connect the window contact.

### Assembly

This module is designed to control radiant elements. **It is required to have one module per radiant element of the system.** Use the guideway to fix it to the motorized element to be controlled (Fig. 14).

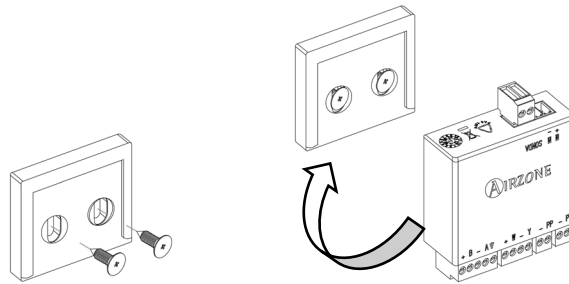
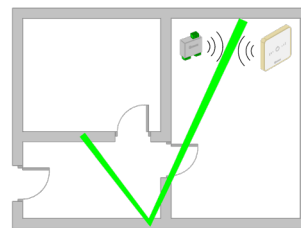
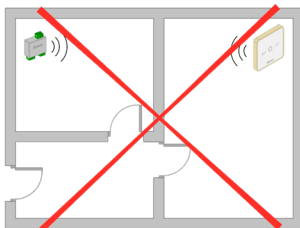

Fig. 14



### WIRELESS OPTION

Place the modules as close as possible to the wireless controller of the zone.



## Connection

The Only Radiant Zone Module is a device that is connected to the Airzone connection bus of the control board (Fig. 15).

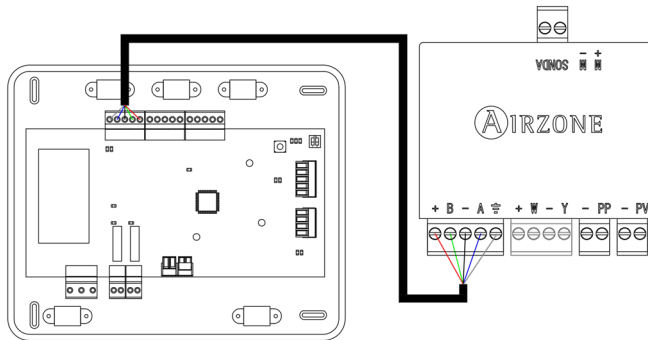

Fig. 15

It has a 5-pin terminal to connect it to the Airzone Connection Bus of the main board. Use the proper cable: shielded twisted pair 4 wired:  $2 \times 0.22 \text{ mm}^2 + 2 \times 0.5 \text{ mm}^2$  (AWG 20 – 4 wired). Attach the wires with the terminal screws following the color code (Fig. 16).

It has a 4-pin terminal to connect the controller. Use the proper cable: shielded twisted pair 4 wired:  $2 \times 0.22 \text{ mm}^2 + 2 \times 0.5 \text{ mm}^2$  (AWG 20 – 4 wired). Attach the wires with the terminal screws following the color code (Fig. 17).

**Remember:** The maximum separation between the module and the controller is 10 meters.

The zoning module allows you to connect a probe (AZZBS10KPROBE) for remote or distributed temperature reading, depending on how the module is configured:

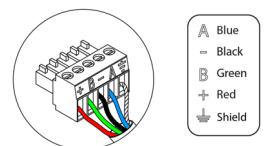

Fig. 16

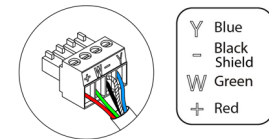

Fig. 17

- **Remote probe:** This function allows you to read the room temperature even if you are not where the controller is located. Connect the probe and configure the module as main module (connected controller). The state and the set-point temperature are set via controller while the probe reads the room temperature.
- **Distributed probe:** This function allows you to control a secondary zone with room temperature reading independent from the main zone. Connect the probe and configure the module as secondary (disconnected controller). The state and the set-point temperature are set via controller while the probe reads the room temperature.

The module has several inputs to control based on the occupancy or if there are open windows.

- **Control by occupancy:** When the occupancy sensor connected to the module indicates that the zone is unoccupied, the system waits for 5 minutes to confirm it is actually empty. After this period of time, the zone is set to Timer Mode and it turns off after 90 minutes.
- **Control by open window:** When the open window sensor connected to the module indicates that a window is open for more than 60 seconds, the control element (actuator/relay) associated with that module closes.

The activation and configuration of these inputs are available in the zone settings menu of the controller (see Advanced Configuration).

## WIRED/WIRELESS ZONE MODULE WITH XXX COMMUNICATION (AZZBSZM XXX [C/R])

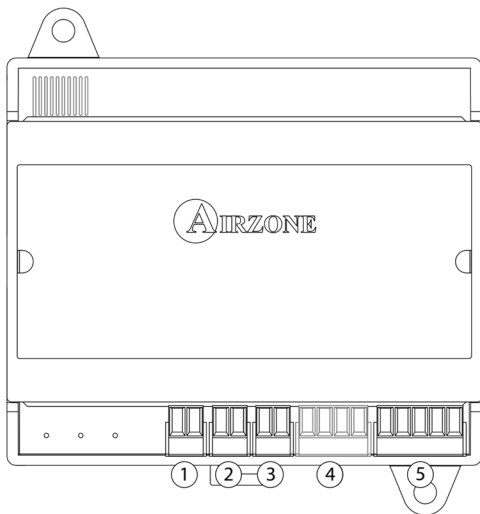

Fig. 18

N°	Description
1	Probe Input
2	Window contact
3	Presence contact
4	Controller Connection (Only AZZBSZMxxxC)
5	Airzone Connection Bus

**Note:** Use a shielded twisted pair to connect the window contact.

### Assembly

The module is mounted on DIN rail (Fig. 19) or on wall (Fig. 20). It must be placed and mounted in accordance with the current electrotechnical regulations.

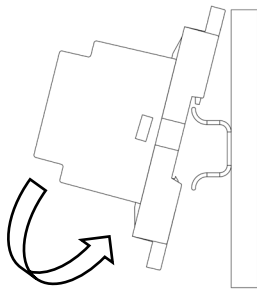

Fig. 19

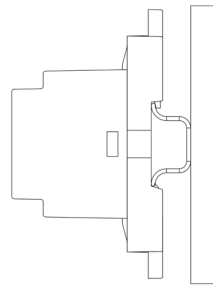
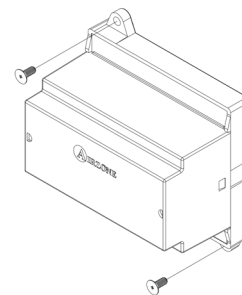

Fig. 20



**Note:** To remove the module on DIN rail, pull the tab down to release it.

### Connection

The gateway module is a device that is connected to the Airzone connection bus of the control board (Fig. 21).

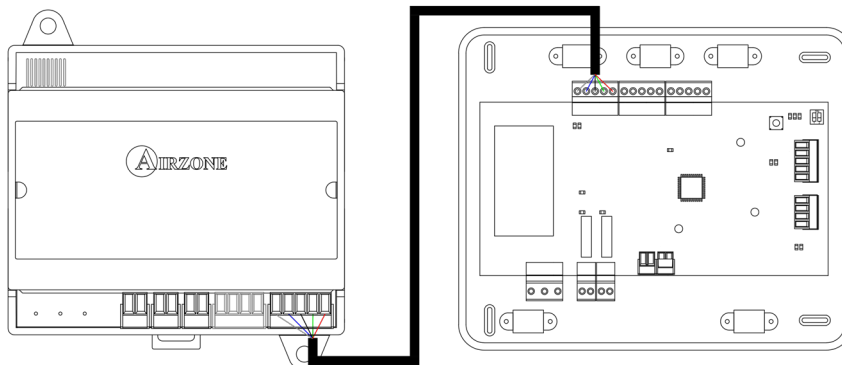

Fig. 21

It has a 5-pin terminal to connect it to the Airzone Connection Bus of the main board. Use the proper cable: shielded twisted pair 4 wired:  $2 \times 0.22 \text{ mm}^2 + 2 \times 0.5 \text{ mm}^2$  (AWG 20 – 4 wired). Attach the wires with the terminal screws following the color code (Fig. 22).

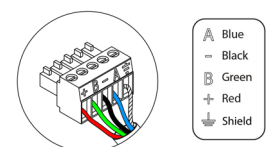

Fig. 22

It has a 4-pin terminal to connect the controller. Use the proper cable: shielded twisted pair 4 wired: 2x0.22 mm<sup>2</sup> + 2x0.5mm<sup>2</sup> (AWG 20 – 4 wired). Attach the wires with the terminal screws following the color code (Fig. 23).

**Remember:** The maximum separation between the module and the controller is 10 meters.

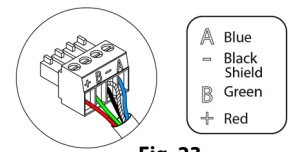

Fig. 23

The module allows to connect a probe (AZZBS10KPROBE) for remote or distributed temperature reading, depending on how the module is configured:

- **Remote probe:** This function allows you to read the room temperature even if you are not where the controller is located. Connect the probe and configure the module as main module (connected controller). The state and the set-point temperature are set via controller while the probe reads the room temperature.
- **Distributed probe:** This function allows you to control a secondary zone with room temperature reading independent from the main zone. Connect the probe and configure the module as secondary (disconnected controller). The state and the set-point temperature are set via controller while the probe reads the room temperature.

The module has several inputs to control based on the occupancy or if there are open windows.

- **Control by occupancy:** When the occupancy sensor connected to the module indicates that the zone is unoccupied, the system waits for 5 minutes to confirm it is actually empty. After this period of time, the zone is set to Timer Mode and it turns off after 90 minutes.
- **Control by open window:** When the open window sensor connected to the module indicates that a window is open for more than 60 seconds, the control element (actuator/relay) associated with that module closes.

The activation and configuration of these inputs are available in the zone settings menu of the controller (see Advanced settings, Zone settings).

## RELAY RADIANT HEAT CONTROL MODULE (AZZBS5OUTPUTS)

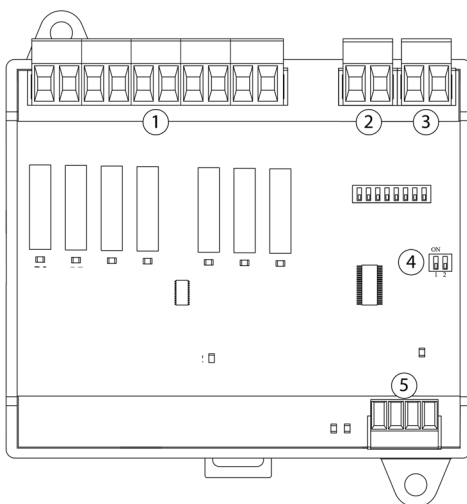

Fig. 24

N°	Description
①	Zone relay
②	Pump control relay
③	Boiler control relay
④	SW2
⑤	Airzone connection bus

**Important:** The Airzone system is not compatible with electric duct heaters, it may result in system malfunction and/or fire.

### Assembly

The module is mounted on DIN rail (Fig. 25) or on wall (Fig. 26). It must be placed and mounted in accordance with the current electrotechnical regulations.

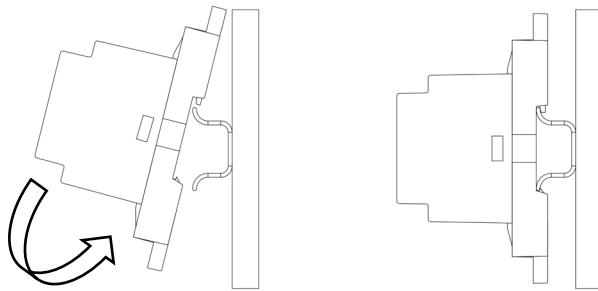

**Fig. 25**

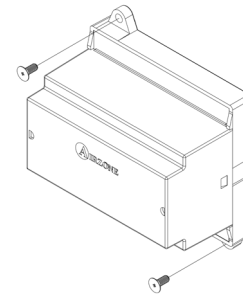
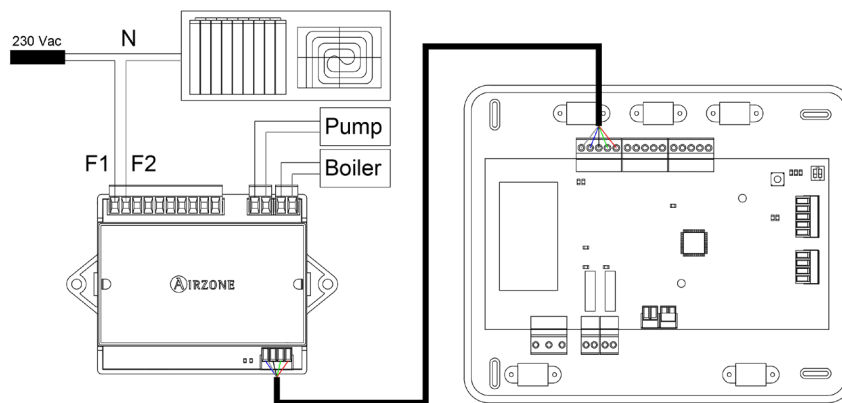

**Fig. 26**

**Note:** To remove the module on DIN rail, pull the tab down to release it.

### Connection

The Relay Radiant Heat Control Module is a device that is connected to the Airzone Connection Bus of the control board (Fig. 27).



**Fig. 27**

Control relay specs: 24/48 Vac (voltage-free). To control elements of a greater power, it is recommended the use of contactors in accordance with the power required. Remember to connect the neutral connector directly from the circuit to the element to be controlled.

The SW2 microswitch configuration (zone ID) is as follows:

SW2	
Zones 1 - 5	Zones 6-10

**Example:** The relay to control a radiant element of a module with address 6 is the R1 of the Relay Radiant Heat Control Module with the address set for the zones 6-10.

It has a 4-pin terminal to connect it to the AC unit bus of the main board. Use the proper cable: shielded twisted pair 4 wired: 2x0.22 mm<sup>2</sup>+2x0.5mm<sup>2</sup> (AWG 20 – 4 wired). Attach the wires with the terminal screws following the color code (Fig. 28).

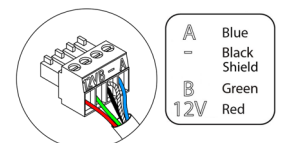

**Fig. 28**



## WIRED CONTROLLERS (AZZBSBLUEFACEC / AZZBSTHINKC / AZZBSLITEC)

### Assembly

Airzone controllers are mounted on the wall through a support. It is recommended not to locate it more than 40 meters (131 feet) away from the control board. To fix it to the wall, follow these steps (Fig. 29):

- Separate the back part of the controller from the wall support and make all the connections.
- Fix the back part of the controller to the wall.
- Place the display on the support once it is fixed.

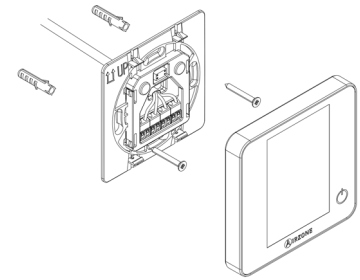

Fig. 29

### Connection

Airzone controllers are connected to the zone module to be controlled. Attach the wires with the terminal screws following the color code (Fig. 30).

**Important:** Use the provided tool to press in the locking tabs (Fig. 31).

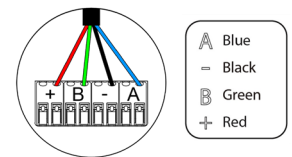

Fig. 30

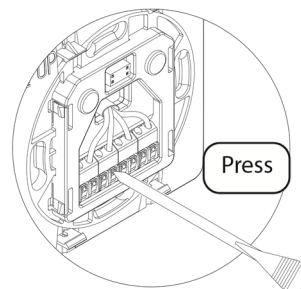
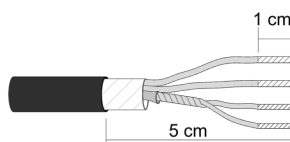

Fig. 31

## WIRELESS CONTROLLERS (AZZBSTHINKR / AZZBSLITER)

### Assembly

Wireless controllers are mounted on the wall through a support. It is recommended not to locate it more than 10 meters (33 feet) away from the control board.

To fix it to the wall, follow these steps (Fig. 32):

- Separate the back part of the controller from the wall support and insert the CR2450 button battery.
- Fix the back part of the controller to the wall.
- Place the display on the support once it is fixed.

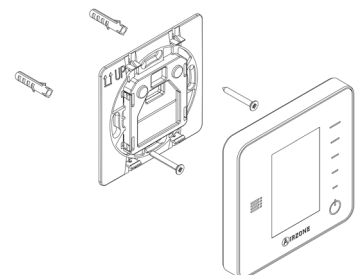

Fig. 32

### Changing batteries

When a Think controller is running out of battery, it displays this icon  on the screensaver (Fig. 33). In the case of the wireless Lite controllers, a warning message will be displayed on the Blueface. In order to know the zone of the Lite controller(s) running out of battery press on the warning icon (Fig. 34).



Fig. 33

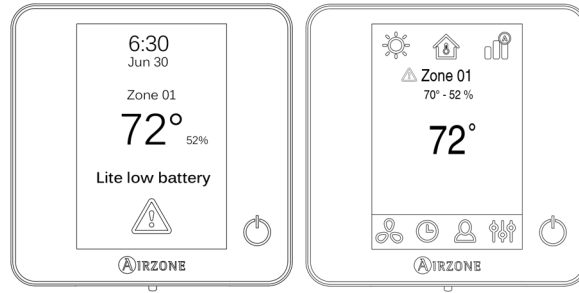

Fig. 34

To replace the battery, separate the controller from its support and replace the battery (CR2450) (Fig. 35).

**Note:** For Lite controllers, the low battery warning will disappear after about 5 minutes from the battery replacement.

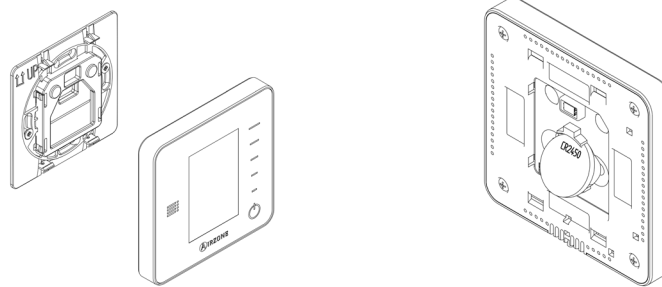

Fig. 35

**Important:** We recommend using of top-brand batteries. Using low-quality batteries may reduce the duration of use. Remember to deposit the old battery into an appropriate recycling point.

### ETHERNET/WIFI CLOUD WEBSERVER (AZZBSWSCLOUD [C/R])

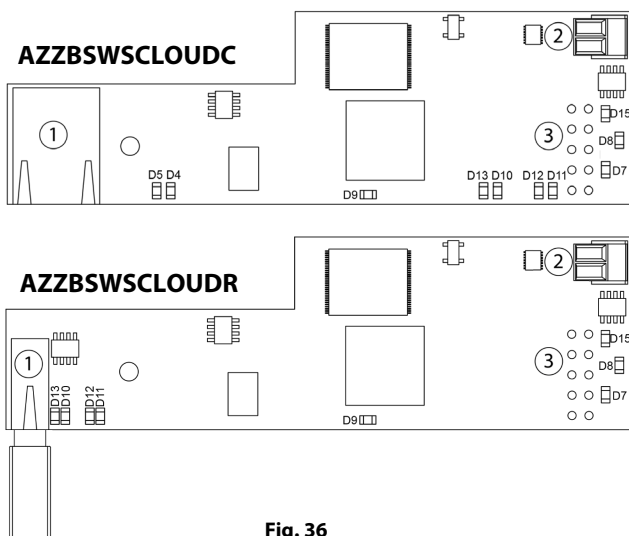

Fig. 36

N°	Description
①	Ethernet WiFi USB connector and antenna
②	Automation bus output
③	Automation bus input



All Airzone systems must be connected to internet to offer technical support.

It is only necessary to connect **one Webserver Cloud per installation** (control of up to 32 systems).

### Assembly

The Webserver is integrated into the automation bus of the Control board (Fig. 37). It has a 5-pin terminal. Disconnect the terminal and fit the connector.

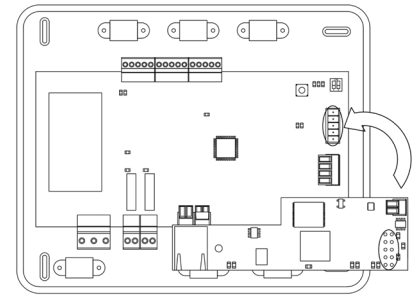

Fig. 37

### Connection

To connect with other system's main boards (Fig. 37), use the 2-pin terminal to connect the Webserver Cloud to the automation bus of the main board. Use the proper cable: shielded twisted pair 2 wired: 2x0.22 mm<sup>2</sup> (AWG 24 – 2 wired). Attach the wires with the terminal screws following the color code (Fig. 38).

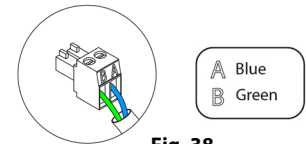
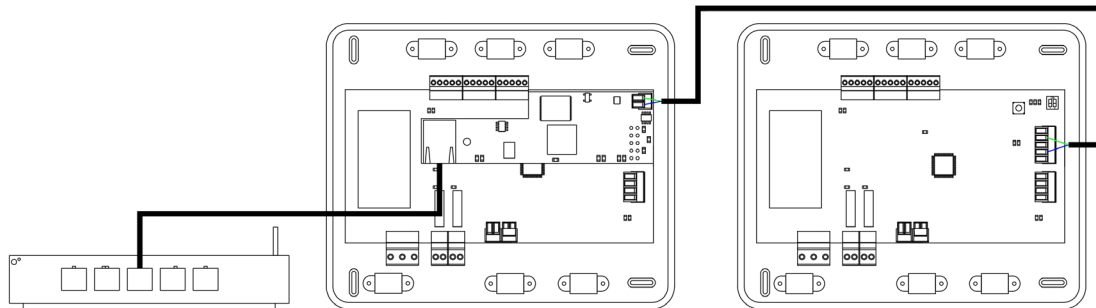

Fig. 38

### AZZBSWBSCLLOUDC



### AZZBSWBSCLLOUDR

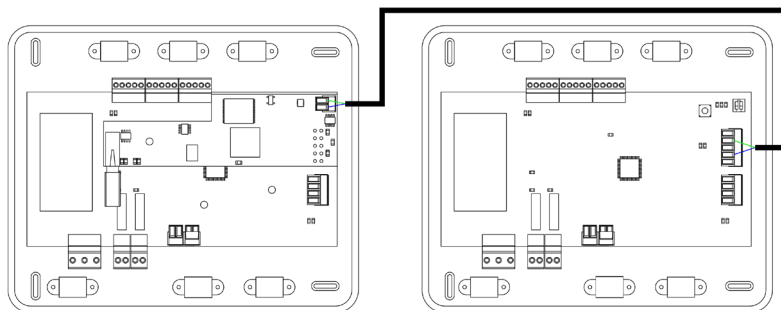

Fig. 39

**Note:** For a proper operation of this module, all the control boards must be addressed (see section Advanced Settings, System ID parameter).

### Configuration

To configure it, follow the steps described in the Airzone Cloud Webserver installation manual, available at [myzone.airzoneusa.com](http://myzone.airzoneusa.com).

## BACNET INTEGRATION GATEWAY (AZZBSBACNETG)

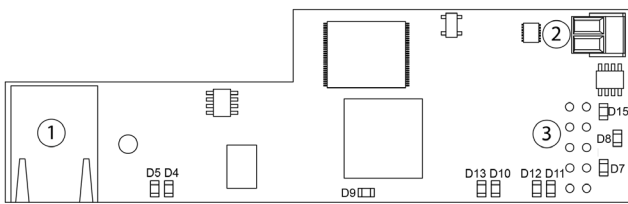

Fig. 40

N°	Description
①	Ethernet
②	Automation bus output
③	Automation bus input



All Airzone systems must be connected to internet to offer technical support.

It is only necessary to connect **one BACnet integration gateway per system**.

### Assembly

The BACnet integration gateway is integrated into the automation bus of the main board (Fig. 41). It has a 5-pin terminal, disconnect the terminal and insert the connector.

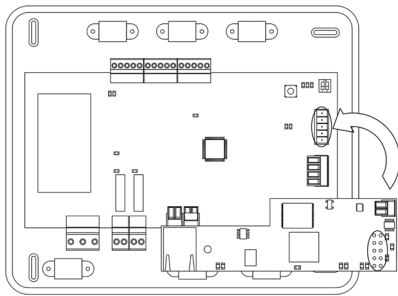

Fig. 41

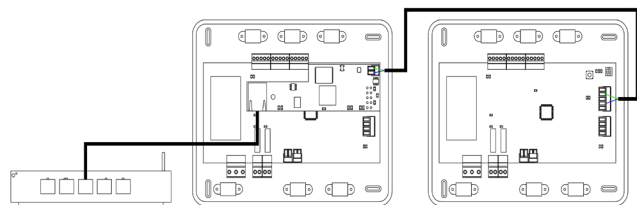

Fig. 42

### Configuration

To configure it, follow the steps described in the installation manual, available at [myzone.airzoneusa.com](http://myzone.airzoneusa.com).

## LUTRON INTEGRATION GATEWAY (AZZBSLUTRONG)

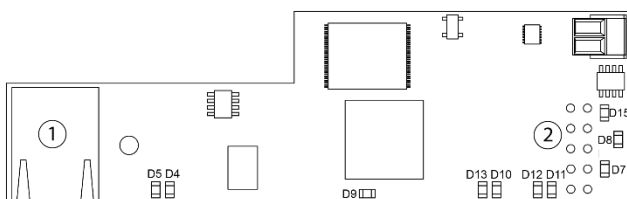

Fig. 43

N°	Description
①	Ethernet
②	Automation bus



All Airzone systems must be connected to internet to offer technical support.

It is only necessary to connect **one Lutron integration gateway per system**.

## Assembly

The Lutron integration gateway is integrated into the automation bus of the main board (Fig. 44). It has a 5-pin terminal, disconnect the terminal and insert the connector.

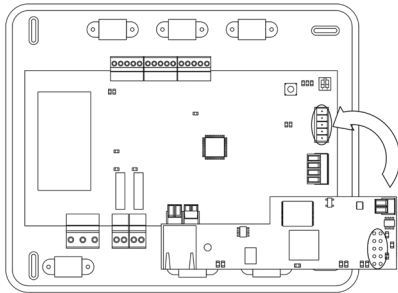

Fig. 44

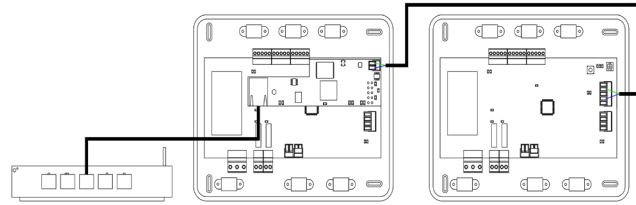

Fig. 45

## Configuration

To configure it, follow the steps described in the installation manual, available at [myzone.airzoneusa.com](http://myzone.airzoneusa.com).

## ASSEMBLY AND CONNECTION EVALUATION

Check the following aspects:

- The state of the LEDs of the control board and the rest of control elements. Check the self-diagnose section of the data sheet of the elements.
- All controllers are powered.

## SECONDARY ZONES SETTINGS

**IMPORTANT:** Can only be configured as secondary zones the zones controlled by a **wired zone module**.

To set secondary zones, follow these instructions:

- Perform the setup according to the next section.
- Disconnect the controller from the secondary module. After a few seconds, this module will be available on the menu of associated outputs.
- Once all secondary modules are configured, configure all modules or main modules and associate the secondary modes required.

**Note:** It is recommended the use of a Blueface controller for configuring secondary zones.

## INITIAL SETUP

Once the system has been installed and all the elements are correctly connected, power the system for its setup.

Follow the steps described in the following sections to configure all controllers.

**Important:** Before performing the initial set up of the system, configure firstly the secondary zones, see *Secondary Zones Settings* section.

**Note:** It is recommended to firstly set the controllers which are going to be configured as main.

## BLUEFACE AND THINK CONTROLLERS

**Important:** Once the setup has been started, it must conclude. You will be able to modify the desired parameters later.

### 1 Language

Select your language. These are the available languages: English, French and Spanish.

To associate a wireless Think controller, start the radio channel search:

#### Setting wireless device

- Open the radio channel. To do that, press on SW1. The LED D19 will remain solid red. Once open, you have 15 minutes to make the association. If that period of time expires, start the process over again. Remember not to open more than one module at the same time, it may alter the process. You can also open the channel association radio through the Blueface (see section *System settings*)

**IMPORTANT:** Do not to open more than one radio channel at the same time, it may alter the process.

- Start the radio channel search, to do so, press Airzone to start the search.

- The controller will display the different wireless zone modules found, with the signal level of each one of them. Select the wanted module and press "Check", the selected module will begin to "beep" to be identified. Verify **the range is correct** (30% minimum) and confirm.

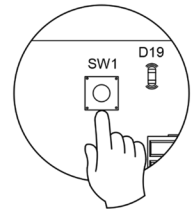

Fig. 46

**IMPORTANT:** Before selecting the zone module which will be associated with the controller, check that this module is the desired one. If this module is not the correct one, use the control bar to select another module and check again.

**IMPORTANT:** The controller will display first the wireless zone modules which are closer to it. Remember to configure this controller near the wireless zone module to associate for greater comfort.

### 2 Units (only if it has not been previously configured by any controller)

Select the units you want to use: Celsius (°C) or Fahrenheit (°F).

### 3 Zone ID

Select the zone associated to the controller. All the zones have a corresponding control output (output for motorized elements or relay radiant heat control module). For example, the zone 1 will control the control relay output O1 of the relay radiant heat control module.

### 4 Linked zones (only if there are previously configured secondary)

If necessary, the system allows you to associate more than one control output to a zone. It is possible to control multiple outputs from the same controller.

**Important:** You must select the zone/s that you want to configure as secondary outputs before pressing "Confirm".

### 5 Controller settings

Select the operation of the controller:

- Main: Controls all the parameters of the installation.
- Zone: Controls all the parameters of the zone.

**6 Control stages** (only for installations with relay radiant heat control module)

Select stages to be controlled in heating and cooling: Air, Radiant or Air+Radiant.

**7 Main ID** (only if the controller has been previously configured as zone)

Select the main controller zone ID with which the controller is associated. Thus, this main controller will impose the operation mode to the controller.

**8 Other settings**

Press to conclude the initial setup procedure, or access the advanced settings to change any other settings. Activate the basic function if required (see *Advanced Settings, Zone settings*).

**Blueface**

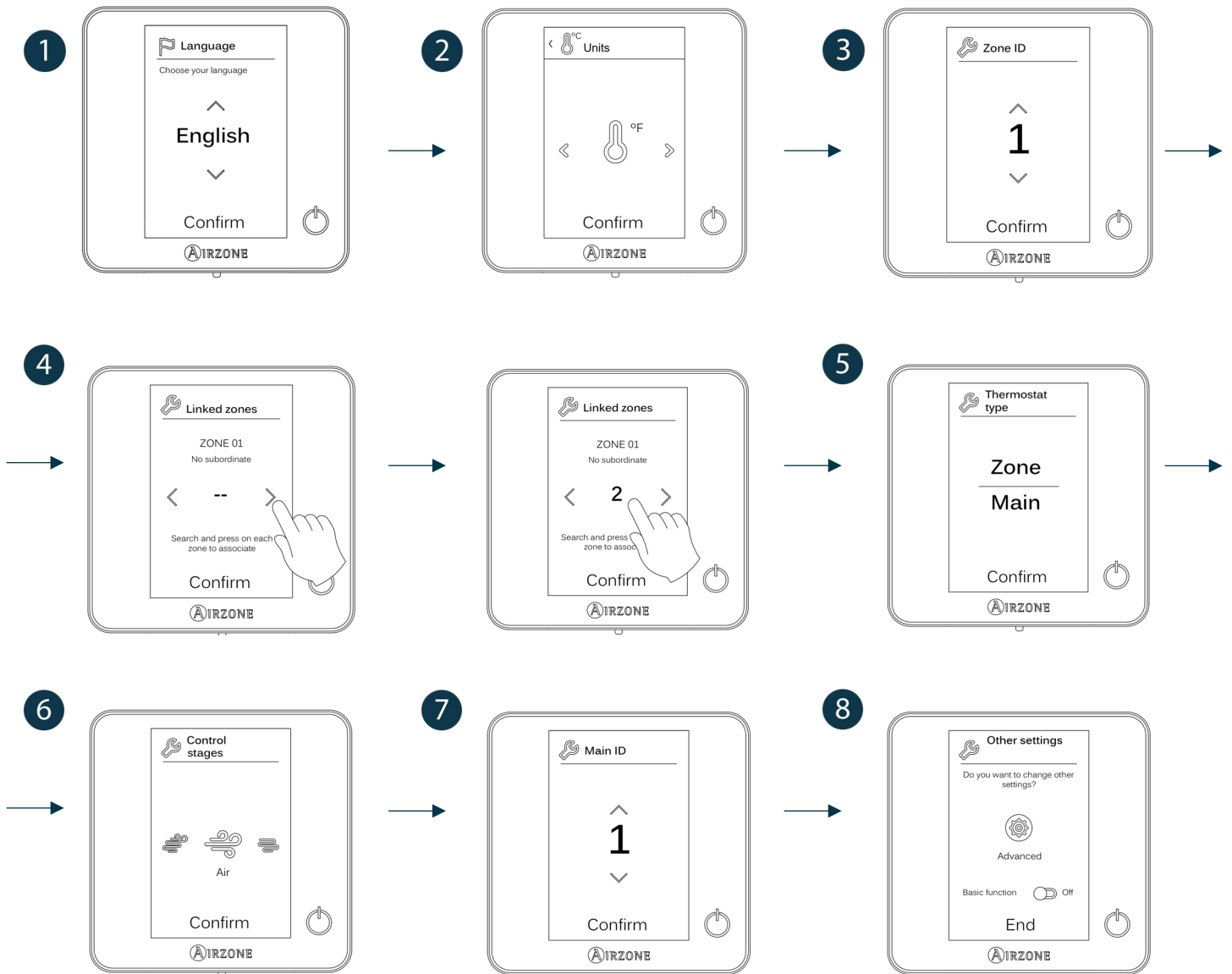

## Think

**Important:** In Think controllers, use **AIRZONE** to confirm and **≡** to return to the previous screen or menu.

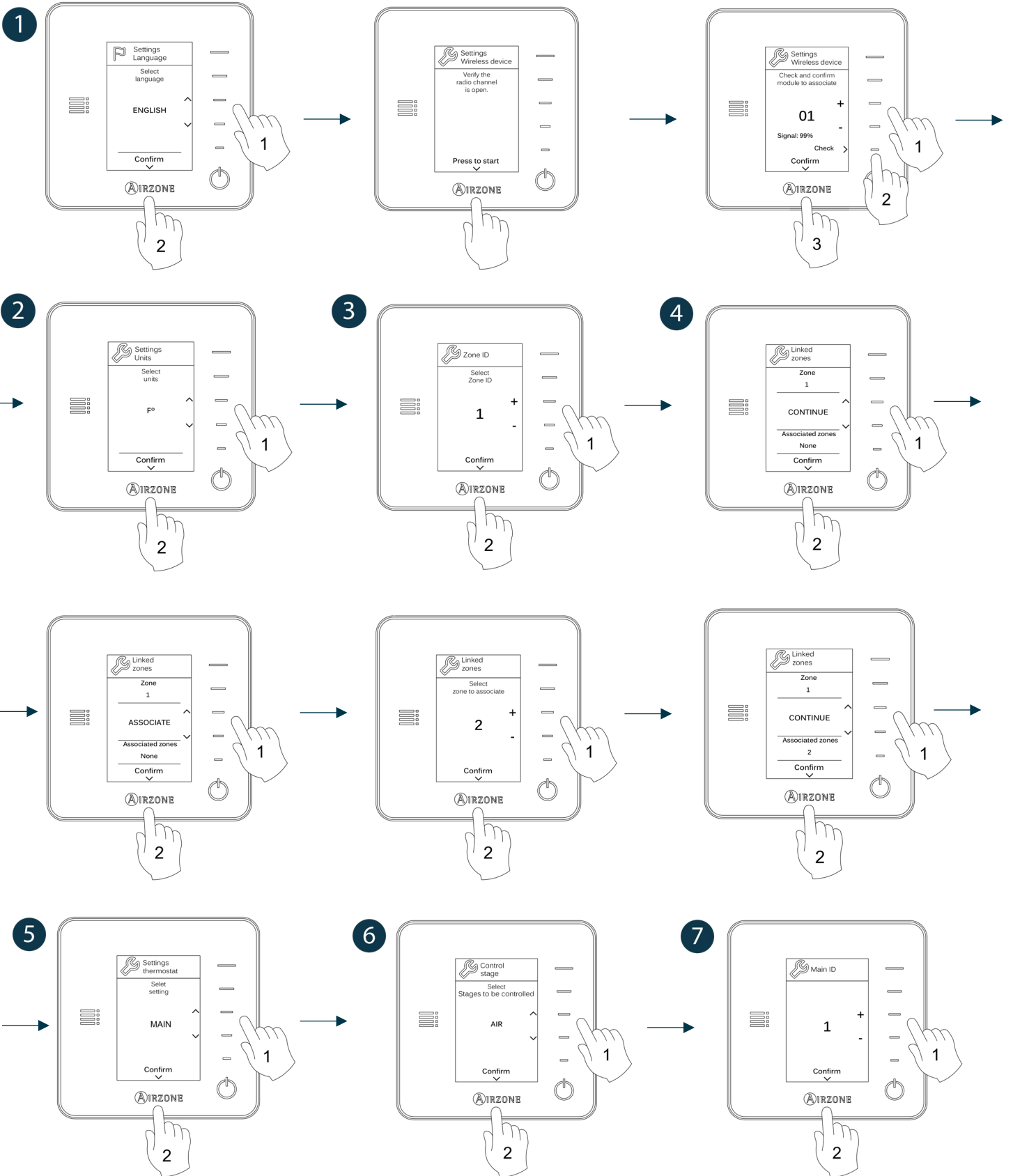



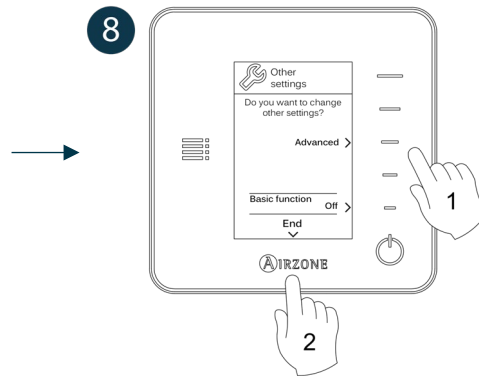





## LITE CONTROLLERS

To configure a Lite controller, follow these steps:









### Wired Lite controller

- Perform all the appropriate connections.
- Connect the controller.
- Press the LED  to confirm the association.
- The number of the zone which associates with the controller is the lowest free available number.
- If the association is correct, the LED  will flash green 5 times.

### Wireless Lite controller

- Open the wireless association channel of the main board, wait a few seconds so the zone module, which will be associated to the controller, opens its wireless association channel (the wireless opening LED must be solid red).
- Insert the battery to supply the controller.
- Press the LED  to begin the wireless search. The LED  will blink in green.

**IMPORTANT:** The controller will display first the wireless zone modules which are closer to it. Remember to configure this controller near the wireless zone module to associate for greater comfort.

- The module which will be associated to the Lite controller will begin to make a “beep” for its identification. The LEDs  will show the signal level of this module:
  -  Low signal range level (It is not recommended to perform the association).
  -  Medium signal range level.
  -  Good signal range level.
  -  Excellent signal range level.
- Press the LED  to confirm the association, otherwise use  to select another module.
- The number of the zone which associates with the controller is the lowest free available number.
- If the association is correct, the LED  will flash green 5 times. If it flashes red twice, it means the controller is out of range.

**REMEMBER:** It is required to set the Main ID parameter of the Lite Controller for its proper functioning (see section *Advanced settings – Blueface controller, Zone settings*).

Configure other functionalities of the LITE controller from the advanced configuration menu of a Blueface controller (see section *Advanced settings, Zone settings*) or Webserver Cloud (See Webserver Cloud installation manual).

**IMPORTANT:** For changing the zone ID, access the parameter Zone ID, inside the advanced settings menu from a Blueface controller (see section *Advanced settings, Zone settings*).

### Lite controller reset

To reset to factory values on any Lite controller, remove the Lite controller from its base, turn up the microswitch 8 and place it again on its base. Press on , the LED will blink green twice when the reset process is completed.

To reassociate it, lower the microswitch 8, place the controller on its base and follow the steps displayed in the *Initial setup section, on Lite Controllers*.

## INITIAL CONFIGURATION EVALUATION

Check the following aspects:

- AC unit-system communication: Choose any mode (except for STOP mode) and switch on the zone to generate demand. Verify that the selected operation mode in the Main controller is shown in the indoor unit controller and the set-point temperature changes.
- Opening-closing of the dampers, ON/OFF of individual AC units and control outputs: Turn on the system and generate demand in all the zones. Then, switch off and on each zone to verify the element to be controlled operates properly.
- Verify that the static pressure of the duct system complies with the air distribution network conditions where is installed (check the Manufacturer's Manual of the equipment if you need to modify this parameter).

**Important:** After the setup or in case of power outage, the system takes a few minutes to measure precisely the temperature and the relative humidity.

## USER AND ZONE SETTINGS

### BLUEFACE CONTROLLER

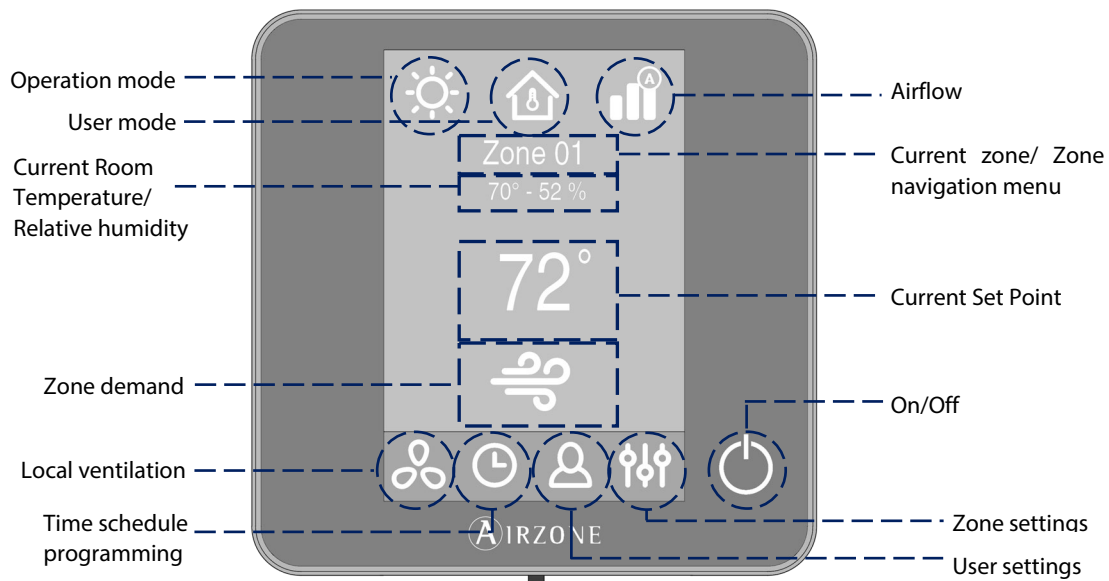

### User Settings

Press to access the menu.

- Language.** Select the language.
- Brightness.** Adjust the brightness and enable or disable the screen brightness when the screen saver is active.
- Date and time.** Press on the clock to set the time and the format type (12 or 24 hours). Press on the calendar to set the date. Installations with webserver enable automatic time change.
- Information.** This parameter provides information on:
  - Zone: firmware, zone, association, actuator or status of the communications.
  - System: firmware, settings and information about the system controllers.
  - Devices: It displays the elements connected to the system.
  - Webserver (Only for system 1 Main controller): firmware, IP address, gateway, MAC and PIN.
  - Warnings and errors on system.
- Clean screen:** Select this option to clean the screen. The touch screen will lock for a few seconds.

### Zone Settings

Press to access the menu.

- Timer.** It is an auto power-off timer of the zone:
  - Off.** Timer is not activated.
  - 30.** It activates the timing and switches off the zone after 30 minutes.
  - 60.** It activates the timing and switches off the zone after 60 minutes.
  - 90.** It activates the timing and switches off the zone after 90 minutes.

**Heating stages** \*. The available parameters are:

**Air**: Only uses air stage.

**Radiant**: Only uses radiant air.

**Air+Radiant**: The system combines both stages to reach comfort quickly and efficiently.

**Note:** For security reasons, the zone will turn off after changing any setting.

\*Available based on the installation and system setting.

**Lite Settings**. To save energy, enables to configure the wired Airzone Lite to switch off after a few second.

**Note:** To access the Lite settings, go to a zone controlled by a Lite controller through the zone navigation menu.

## THINK CONTROLLER

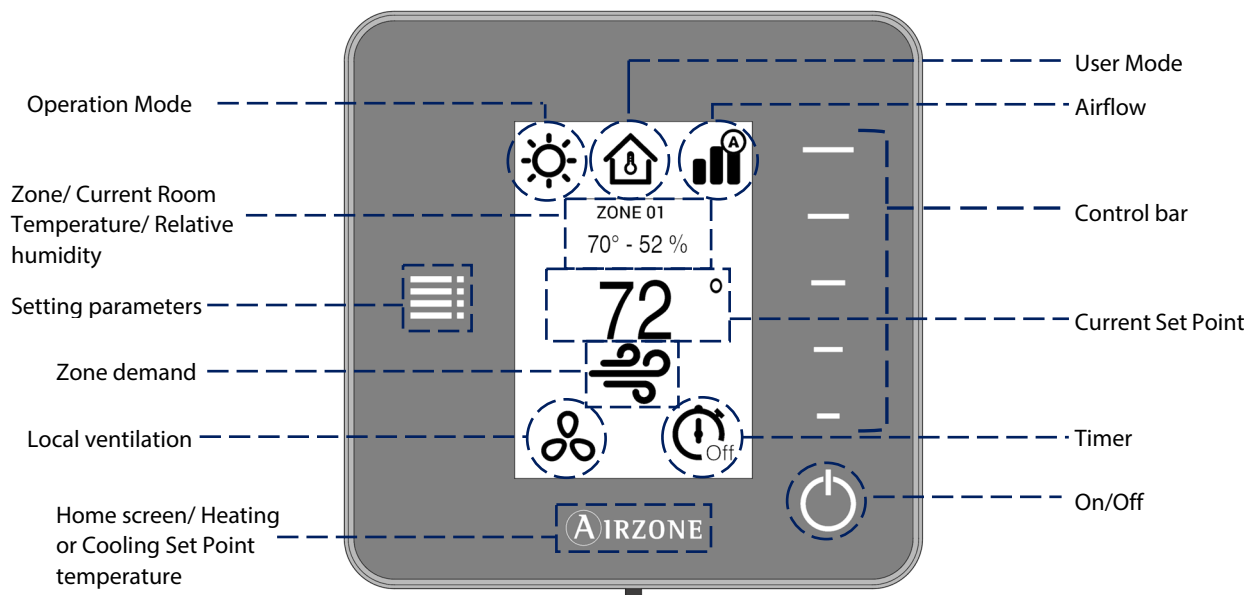

**Remember:** Use to confirm and for going back if browsing submenus.

## Setting Parameters

Press to access the menu:

**Operation Mode.** This parameter is only available when the Think controller is configured as main, the available modes are:

**Cool.** The conditioning unit will start a cooling cycle any time that any zone is in cool demand ( $T_{Set-Point} < T_{room}$ ).

**Heat.** Enables the heating cycle whenever a zone is in heating demand ( $T_{Set-Point} > T_{room}$ ).

**Auto.** The Auto mode allows automatic switching between cool and heat, depending on the global demand.

**Dry.** In this mode, the air-conditioning unit will start a dehumidification cooling cycle any time that any zone is under demand ( $T_{Set-Point} < T_{room}$ ).

**Note:** Dry mode decreases humidity in the room by entering the dehumidification cooling cycle.

**Emergency Heat.** This mode activates the Auxiliary Heat to provide heated air in case of a mechanical failure in the system.

**Note:** This mode is only visible when the installation includes an auxiliary heating device.

**User Mode.** This parameter is only available when the Think controller is configured as main, the available modes are:

**Comfort.** Default and standard user mode. The desired set point temperature can be selected using the predefined temperature ranges.

**Eco.** The range of available set point temperatures change for more efficient operation.

**Night time.** The system automatically changes the set point temperature 0.5° C/1° F every 30 minutes in up to 4 increments of 2° C/4° F in 2 hours. When cooling, the system increases the set point temperature; when heating, the system decreases the set point temperature.

**Unoccupied.** This mode aims to short periods of absence. Avoids the temperature to surpass the established limit temperature for cooling and heating mode, generating demand with a set-point temperature previously established by the installer (27° C / 81° F in cooling mode and 17° C / 63° F in heating mode by default) for returning to the allowed values, as long as the zone is on.

When interacting with the zone while this mode is selected, the controller displays the unoccupied override warning. If the set-point temperature is changed, it is maintained for the pre-established period of time (60 minutes by default) and returns to the set-point temperature of the unoccupied mode.

**Vacation.** This mode aims to long periods of absence. It turns off all the zones to save energy and turns them on avoiding the temperature to surpass the established limit temperature (35° C / 95° F in cooling mode and 10° C / 50° F in heating mode), generating demand with the previous set-point temperature before activating the vacation mode.

When interacting with the zone while this mode is selected, the controller displays the vacation override warning. If the set-point temperature is changed, it is maintained for the pre-established period of time (60 minutes by default) and turns off the zones again.

**Stop.** The air-conditioning system will remain switched off regardless of the demand status of any zone, all the motorized dampers will remain opened.

**Airflow control.** This parameter is only available when the controller is configured as main of a zoned system, selects the control algorithm that best fits the installation. The available options are:

**Silence.** The fan speed is lower than in standard mode to reduce the noise.

**Standard.** Set by default. The system automatically regulates the fan speed based on the number of zones calling for cooling or heating.

**Power.** The fan speed is higher than in standard mode to increase the flow.

**Fan Speed.** This parameter is only available in zones with individual units, it is used to set the airflow control of the AC unit fan. The fan speed is set in automatic speed by default.

**High speed**     
 **Medium speed**     
 **Low speed**     
 **Automatic speed**



**Heating stages.** This option is only available if the zone is configured as air+radiant configuration and enables to choose the stage of the zone. The available parameters are:

**Air.** Only uses air stage.

**Radiant.** Only uses radiant air.

**Air+radiant.** The system combines both stages to reach comfort quickly and efficiently.

**Note:** For security reasons, the zone will turn off after changing any setting.

**Local Ventilation.** This option enables the activation  or deactivation  of the ventilation in the selected zone when the system is not actively cooling or heating any of the zones.

**Timer.** It is an auto power-off timer of the zone.

 **Off.** Timer is not activated.

 **30.** It activates the timing and switches off the zone after 30 minutes.

 **60.** It activates the timing and switches off the zone after 60 minutes.

 **90.** It activates the timing and switches off the zone after 90 minutes.

**Information.** This parameter provides information about:

- Zone: firmware, zone, association, actuator or communication status.
- System: firmware, settings and information about the system controllers.
- Devices: displays the elements connected to the system.
- Webserver (Only for system 1 Main controller): firmware, IP address, gateway, MAC and PIN.

**Main zone.** This parameter is only available when the Main controller of the group is lost. Enables to access and to modify the operation mode of the group.

## ADVANCED SETTINGS

### ADVANCED SETTINGS – BLUEFACE CONTROLLER

To access the advanced configuration menu, follow the next steps:

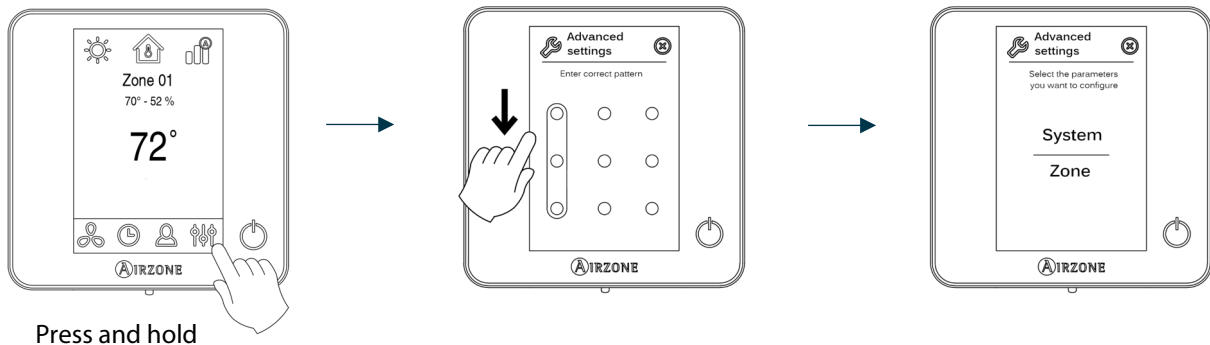

From this menu you can control both the zone parameters and the system parameters.

### System settings

- **System ID** (not available on systems with BACnet gateway). Defines the number of the system within your installation.
- **Temperature range.** Selects the highest temperature in heating mode (18-30°C / 64-86°F, 30°C / 86°F by default) and the lowest temperature in cooling mode (18-26°C / 64-78°F, 18°C / 64°F by default). It is also possible to disable some of the modes.
- **Global Ventilation.** This menu allows you to activate/deactivate the fan mode in all zones when the system is not actively heating or cooling any zones. By default, the global ventilation is deactivated. When activated, the following settings are used to configure Global Ventilation:
  - **Every (min).** Configure the length of the interval (in minutes) between periods of ventilation. Configurable from 5 to 40 minutes, in 5 minutes increments (by default, 15 minutes).
  - **Run For (min).** Configure the time duration that ventilation is activated (in minutes). Configurable from 5 to 20 minutes, in 5 minutes increments (by default, 10 minutes).

**Note:** when global ventilation is activated, a warning message will appear on the screensaver.

- **Anti-freezing.** This feature prevents the room temperature from lowering below 12°C / 53°F, although your zone is off. It is deactivated by default.
- **Type of opening** (only available in installations with intelligent damper). Use this parameter to configure the type of opening of the damper output: All/Nothing or Modulating (by default).
 

**\*Note:** If you change this parameter, all the dampers of the installation will be affected.
- **Minimum air** (only available in installations with intelligent damper and with the parameter Type of opening configured as modulating). Enables/disables the entry of a minimum airflow in zones where the set point temperature has been reached. When the zone is off, the damper shuts completely.
 

**\*Note:** If you change this parameter, all the dampers of the installation will be affected.
- **Auxiliary Heat.** This menu is used to enable/disable the auxiliary heat. By default, the auxiliary heat is disabled. When auxiliary heat is enabled, the following parameters are used to configure the operation of the auxiliary heat:

#### Configuration Menu

- **Available Stages.** Defines how many stages of auxiliary heat a system has.
- **First Supply Heat.** If the setting for Auxiliary heat is 1 or 2, then the first system to supply heat must be defined as either: Heat Pump or Aux. Heat.
- **Fan Configuration.** Select between Electric (Fan on) or Furnace (Fan off) option. If you select Electric option, define:
  - **Fan Delay (s).** Defines the delay time (in seconds) to turn off the fan when there is no demand from the Auxiliary Heater. Possible values are 0, 45, 60 and 120 seconds.

### First Stage Menu

- **First Stage Differential.** Temperature that the system has to surpass to activate the first stage of auxiliary heat. Values: 1 to 5°C / 2 to 10°F in increments of 0.5°C / 1°F. By default, 1°C / 2°F.
- **First Stage Hysteresis.** Defines the hysteresis for the operation of the first stage. Values: 1 to 5°C / 2 to 10°F in increments of 0.5°C / 1°F. By default, 1°C / 2°F.
- **Min. Time Exhausted.** Minimum time that the Heat Pump must be active before the first stage of auxiliary heat can be activated. Possible values are 0, 45, 60 and 120 minutes. By default, 45 minutes.

### Second Stage Menu

- **Second Stage differential.** Temperature that the system has to surpass to activate the second stage of auxiliary heat. Values: 1 to 5°C/2 to 10°F in increments of 0.5°C/1°F. By default, 1°C / 2°F.
- **Second Stage Hysteresis.** Defines the hysteresis for the operation of the second stage. Values: 1 to 5°C / 2 to 10°F in increments of 0.5°C / 1°F. By default, 1°C / 2°F.
- **Min. Time Exhausted.** Minimum time that the first stage must be active before the second stage of auxiliary heat can be activated. Possible values are 0, 45, 60 and 120 minutes. By default, 45 minutes.
- **Autochange.** This option allows the user to configure the three values that define the auto-changeover operation that sets the mode of the indoor unit.
  - **Setpoint Differential.** Defines the minimum differential between heating and cooling set points. Values: 0 to 3.5°C / 0 to 7°F in increments of 0.5°C / 1°F, by default 1°C / 2°F.
  - **Mode Switching Protection (min).** Defines the minimum run time before allowing a mode change. Possible values are 15, 30, 60 and 90 minutes. By default, 30 minutes.
  - **Heat OVR Temp.** If a zone has a higher heating demand than this temperature, the system reverts heating operation even if the cooling global demand exceeds the global heat demand. Possible values are: Off, 1.5 to 4°C / 3 to 8°F in increments of 0.5°C/1°F. Default value: Off.
- **Away mode settings.** This option configures the following parameters of the unoccupied user mode and the vacation user mode:
  - **Hysteresis.** If the set point temperature is surpassed by the differential defined, the zone will cease demand. Range: 1 to 3.5°C / 2 to 7°F in steps of 0.5°C / 1°F. By default, 3°C / 6°F.
  - **Override Time.** Sets time that the zone will resume the selected away mode when the user touches the controller screen during an away period. Values: 10 to 120 minutes in steps of 10 minutes. By default, 60 minutes.
- **Heating stage.** This option configures the following parameters of the Air+Radiant control stage (see parameter *Control stages* for more information):
  - Temperature gap. Defines the temperature gap after which the second stage must be activated.
  - First stage. Defines the first stage to operate: Air or Radiant.
- **BACnet.** This parameter displays the Device ID, the uplink port, the IP address, the subnet mask and the Gateway IP and allows you to modify them. Press on the value you want to change, modify it and then press to confirm. The values by default are:
  - Device ID: 1000
  - Port: 47808
  - IP Address: DHCP
- **Supply temperature** (*only available in installations with Airzone ZBS 10 KOhm NTC thermistor*). This option allows the system demand to be ignored if the supply temperature exceeds a certain limit. The selectable heating cut out temperatures are 38-46-54-62-70°C / 100-114-129-143-158°F. By default, the system will stop heating if the supply temperature reaches 54°C / 129°F.  
**Note:** *The system will not generate heat until past 4 minutes (minimum) from the shut of demand.*
- **Room temperature.** This option allows the room temperature and relative humidity to be shown/hidden. By default, the room temperature is shown.
- **Radio channel.** It activates/deactivates the radio channel of the system.
- **Reset system** (*only available for main controller*). Resets the system and returns to factory settings. To reconfigure the controllers, please check *Initial setup*. Wait 60 seconds until the system restarts before connecting again.



## Zone settings

- **Zone ID** (*only available from remote zones, in zones controlled by Lite controllers*). Shows and allows to modify the zone number assigned among the availables.
 

**Important:** *It is necessary to set the Main ID parameter of the controller for its proper functioning.*
- **Linked zones.** It displays and allows you to select the control outputs associated with the controller.
- **Controller settings.** Use this parameter to define the controller as Main or Zone.
- **Main ID** (*only available if the controller is configured as zone*). Sets the main zone, which imposes its mode to this zone (only set-point temperature and airflow features will be configurable).
- **Use mode.** The controllers can be set in Basic or Advanced mode. They are set in Advanced mode by default. These are the parameters you can control in basic mode: On/off, set-point temperature, airflow and operation mode. If you need to reset the controller to Advanced mode, access the advanced configuration menu and then activate the advanced use mode.
- **Offset.** Correction factor for the room temperature of the zones (range: from -2.5°C to 2.5 °C / -5°F to 5°F in steps of 0.5°C / 1°F). It is in 0°C / 0°F by default.
- **Control stages.** This parameter is used to select cooling/heating stages in the zone. These are the features to be configured:
  - Air: It activates the heating air in the zone.
  - Radiant: It activates radiant heating.
  - Air+Radiant: It activates both air and radiant heating in the zone and also allows the user to select the desired heating stage: Air, Radiant or Air+Radiant.
  - Off: It deactivates the cooling/heating stage in the zone.
- **Occupancy contact.** It determines the state of the module of a zone based on the occupancy. It only has effect on the zone module if it is associated to a controller (it does not operate in secondary zone modules). When this contact is on, if the zone is empty for over 5 minutes, the Timer 90 feature is activated (displaying an Occupancy notification on the controller). It is off by default. In order to activate this feature, configure it as Normally open or Normally closed.
- **Window contact.** This option allows the control the state of a zone module based on the opening of the window. It only has effect on the control element of the zone module. When this contact is on, if it detects any open window, it turns off the zone after 60 seconds (displaying an Open window notification on the controller). It is off by default. In order to activate this feature, configure it as Normally open or Normally closed.
- **User mode setpoint.** This option is used to configure the set point temperature of each user mode for each zone:
  - **Comfort.** Heat: 15 to 30°C / 59 to 86°F by default 20°C / 68°F. Cool: 18 to 30°C / 64 to 86°F, by default 24°C / 75°F.
  - **Eco.** Heat: 15 to 30°C / 59 to 86°, by default 19°C / 66°F. Cool: 18 to 30°C / 64 to 86°F, by default 25°C / 77°F.
  - **Unoccupied.** Heat: 15 to 22°C / 59 to 72°F, by default 17°C / 63°F. Cool: 24 to 30°C / 75 to 86°F, by default 27°C / 81°F.
  - **Vacation.** Heat: 10 to 16°C / 50 to 61°F, by default 10°C / 50°F. Cool: 29 to 35.5°C / 84 to 96°F, by default 35°C / 95°F.
- **Weight.** This option is used to set the weight of each zone for purposes of determining system operation. The weight of the zone will be used for calculating the mode (auto-change over) or for calculating heat demands when using auxiliary heat. It is an indicator of the size / importance of the zone. Possible values range from 1-100. By default, the weighting is set to Auto and each zone's weight is automatically generated based on the number of zones. For example, if there are four zones, each zone's weight is automatically set to 25. If this option is disabled, the weight of the zone can be set manually.
- **Reset controller** (*not available in remote zones*). Allows you to reset the controller and returning it to the default values.

## ADVANCED SETTINGS – THINK CONTROLLER

To access the advanced configuration menu, follow the next steps:

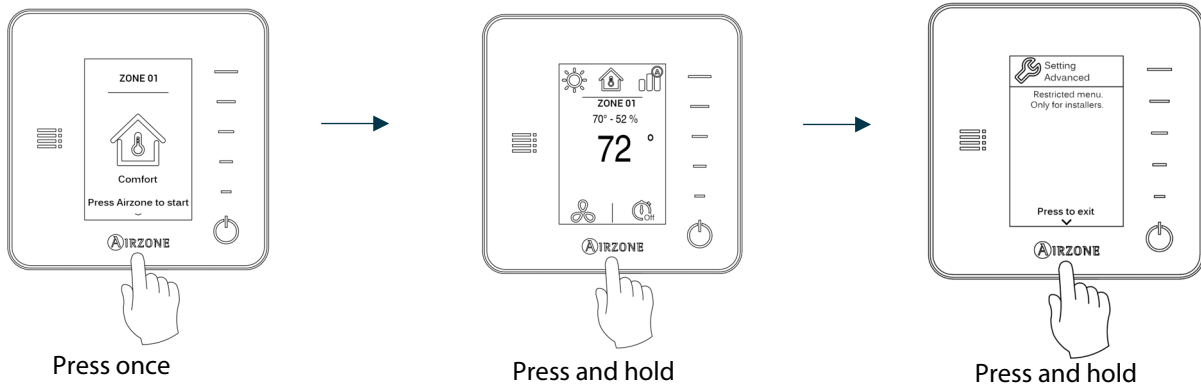

**Important:** In Think controllers, press to confirm and to return to the previous menu/screen.

- **Linked zones.** It displays and allows you to select the control outputs associated with the controller.
  - **Controller settings.** Use this parameter to define the controller as Main or Zone.
  - **Main ID** (*only available if the controller is configured as zone*). Sets the main zone, which imposes its mode to this zone (only set-point temperature and airflow features will be configurable).
  - **Use mode.** The controllers can be set in Basic or Advanced mode. They are set in Advanced mode by default. These are the parameters you can control in basic mode: On/off, set-point temperature, airflow and operation mode.
- If you need to reset the controller to Advanced mode, access the advanced configuration menu and then activate the advanced use mode.
- **Offset.** Correction factor for the room temperature of the zones (range: from -2.5°C to 2.5 °C / -5°F to 5°F in steps of 0.5°C / 1°F). It is in 0°C / 0°F by default.
  - **Control stages.** This parameter is used to select cooling/heating stages in the zone. These are the features to be configured:
    - Air: It activates the heating air in the zone.
    - Radiant: It activates radiant heating.
    - Air+Radiant: It activates both air and radiant heating in the zone and also allows the user to select the desired heating stage: Air, Radiant or Air+Radiant.
    - Off: It deactivates the cooling/heating stage in the zone.
  - **Occupancy contact.** It determines the state of the module of a zone based on the occupancy. It only has effect on the zone module if it is associated to a controller (it does not operate in secondary zone modules). When this contact is on, if the zone is empty for over 5 minutes, the Timer 90 feature is activated (displaying an Occupancy notification on the controller). It is off by default. In order to activate this feature, configure it as Normally open or Normally closed.
  - **Window contact.** This option allows the control the state of a zone module based on the opening of the window. It only has effect on the control element of the zone module. When this contact is on, if it detects any open window, it turns off the zone after 60 seconds (displaying an Open window notification on the controller). It is off by default. In order to activate this feature, configure it as Normally open or Normally closed.
  - **Weight.** This option is used to set the weight of each zone for purposes of determining system operation. The weight of the zone will be used for calculating the mode (auto-change over) or for calculating heat demands when using auxiliary heat. It is an indicator of the size / importance of the zone. Possible values range from 1-100. By default, the weighting is set to Auto and each zone's weight is automatically generated based on the number of zones. For example, if there are four zones, each zone's weight is automatically set to 25. If this option is disabled, the weight of the zone can be set manually.
  - **Reset controller.** Allows you to reset the controller and returning it to the default values.

## SELF-DIAGNOSE

### CONTROL BOARD (AZZBSR2MEL)

Airzone control boards have integrated LEDs that detect unusual operations.

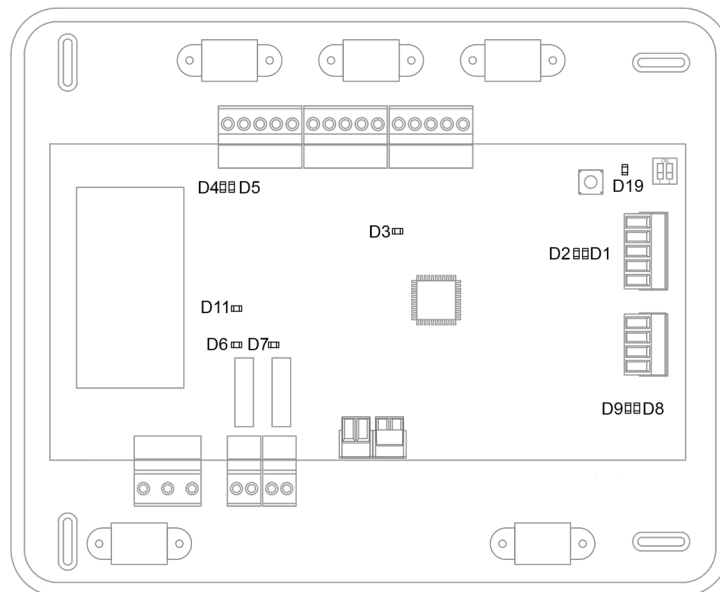
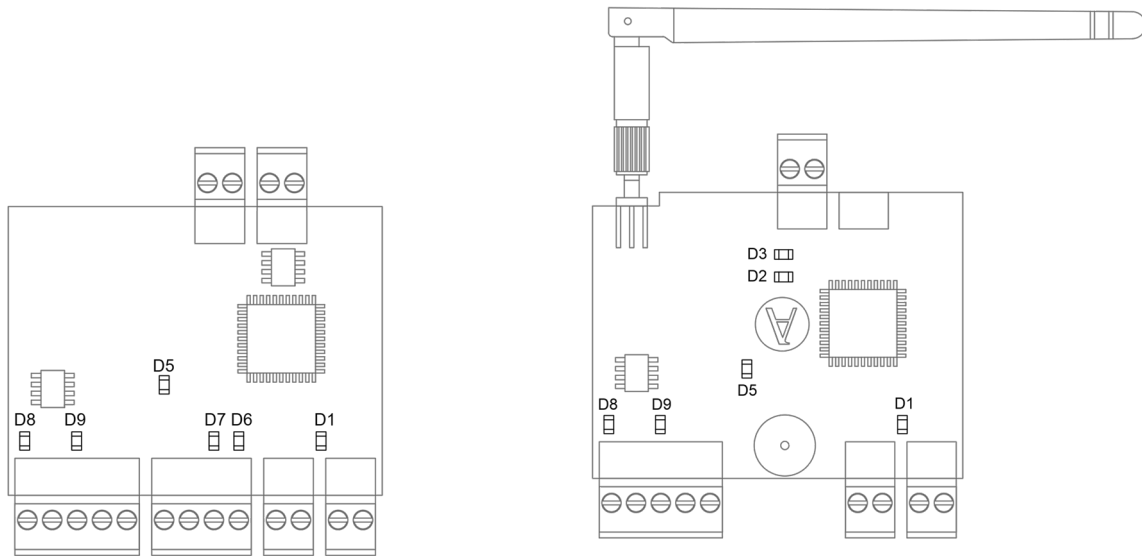

Fig. 47

Meaning			
D1	Data reception from automation bus	Blinking	Green
D2	Data transmission from automation bus	Blinking	Red
D3	Control board activity	Blinking	Green
D4	Data transmission from Airzone Connection Bus	Blinking	Red
D5	Data reception from Airzone Connection Bus	Blinking	Green
D6	1st Stage Auxiliary heat activated	Switches	Green
D7	2nd Stage Auxiliary heat activated	Switches	Green
D8	Data transmission from AC unit bus	Blinking	Red
D9	Data reception from AC unit bus	Blinking	Green
D11	Control board power supply	Steady	Red
D19	Association channel: active	On	Red

## WIRED/WIRELESS INTELLIGENT ROUND DAMPER AND WIRED/WIRELESS ONLY RADIANT ZONE MODULE (AZZBSDAMPERXXX [C/R] AND AZZBSZMRAD [C/R])

The intelligent round damper module and only radiant zone module have integrated LEDs that detect unusual operations.



**AZZBSDAMPERxxxC and AZZBSZMRADC**

**AZZBSDAMPERxxxR and AZZBSZMRADR**

**Fig. 48**

Meaning			
D1	Module operating	Blinking	Green
D2	Wireless data packets reception	Switches	Green
D3	Association channel: active	Steady	Red
D5	Power supply	Steady	Red
D6	Data reception from controller	Blinking	Green
D7	Data transmission from controller	Blinking	Red
D8	Data reception from Airzone connection bus	Blinking	Green
D9	Data transmission from Airzone connection bus	Blinking	Red

## WIRED/WIRELESS ZONE MODULE WITH XXX COMMUNICATION (AZZBSZM XXX [C/R])

The zone modules have integrated LEDs that detect unusual operations.

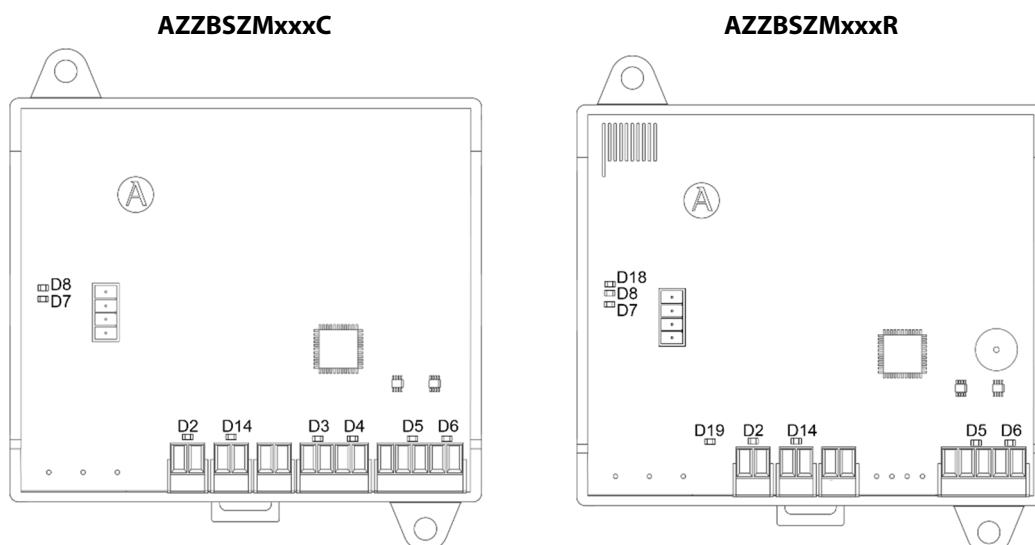

**AZZBSZMxxxC**

**AZZBSZMxxxR**

**Fig. 49**

Meaning			
D2	Power supply	Steady	Red
D3	Data transmission from controller	Blinking	Red
D4	Data reception from controller	Blinking	Green
D5	Data transmission from Airzone connection bus	Blinking	Red
D6	Data reception from Airzone connection bus	Blinking	Green
D7	Data transmission from gateway	Blinking	Red
D8	Data reception from gateway	Blinking	Green
D14	Module operating	Blinking	Green
D18	Wireless data packets reception	Switches	Green
D19	Association channel active	Steady	Red

### RELAY RADIANT HEAT CONTROL MODULE (AZZBS5OUTPUTS)

The relay radiant heat control modules have integrated LEDs that detect unusual operations.

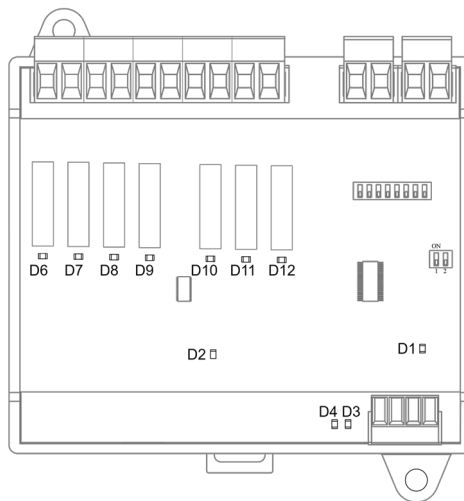



Fig. 50

Meaning			
D1	Power supply	Steady	Red
D2	Module operating	Blinking	Green
D3	Data reception from Airzone connection bus	Blinking	Green
D4	Data transmission from Airzone connection bus	Blinking	Red
D6...D12	Leds of relay state	Blinking	Green

## BLUEFACE AND THINK CONTROLLERS (AZZBSBLUEFACEC / AZZBSTHINK [C/R])

### Blueface and Think Controller Warnings

Controller displays all the system warnings on the screensaver. If there is any error, it will be displayed on the screensaver, on the main screen and on "Information", inside the "User settings" menu.



- **Anti-freezing** (only Blueface). It will be only displayed when it is activated (See *Advanced Configuration – Blueface controller, system parameters*).
- **Unoccupied Override**. A zone has been activated while the user mode is set on Unoccupied. If the set-point temperature is changed, it is maintained for the pre-established period of time (60 minutes by default) and returns to the set-point temperature of the unoccupied mode.
- **Vacation Override**. A zone has been activated while the user mode is set on Vacation. If the set-point temperature is changed, it is maintained for the pre-established period of time (60 minutes by default) and turns off the zones again.
- **Window**. It indicates the air conditioning of the zone has been deactivated due to open window. Only available if the window contact of the system is activated.
- **Global ventilation** (only Blueface). The global ventilation is activated.
- **Occupancy**. It indicates no occupancy has been detected in the zone for the last 5 minutes. Therefore, the Timer function is activated (the zone will switch off after 90 minutes). Only available for systems with occupancy.
- **Low Battery Lite** (only Blueface). Low battery warning. Informs about the involved zone when the icon is pressed.  
*Note: For Lite controllers, the low battery warning will disappear after about 5 minutes from the battery replacement.*
-  **Battery** (only Think wireless). Low battery warning.

### Blueface and Think Controllers errors

If any type of anomaly is detected, the word "Error" is displayed on the screensaver of these devices. You may find the following errors:

#### **Error 1: Communication error between wired controller and zone module (AZZBSDAMPERxxC / AZZBSZMRADC / AZZBSZMxxxC)**

This incident blocks the control of the zone. To solve this incident check:

1. Connection: Check the polarity of the connectors of the module and the controller.
2. Wiring: Check that the voltage between the poles (A /-) and (B/-) is about 0.65 Vdc.
3. Wiring: Verify that the module connection bus-controller is not next to low-voltage wiring.
4. Module: Check the correct operation of the module, for this connect another controller and verify that the error disappears.
5. Restart the zone and re-associate it with the system:
  - Blueface controllers: Press on Reset to restart the device. If the error persists, press and hold on  and reset the controller. Configure the system.
  - Think controllers: To do this, press and hold on  and restart the start-up configuration process.
6. Restart system: If the system is restarted, this error may be displayed in the controllers at the beginning of the process. This message should disappear after around 30 seconds.

**AZZBSDAMPERxxC / AZZBSZMRADC**

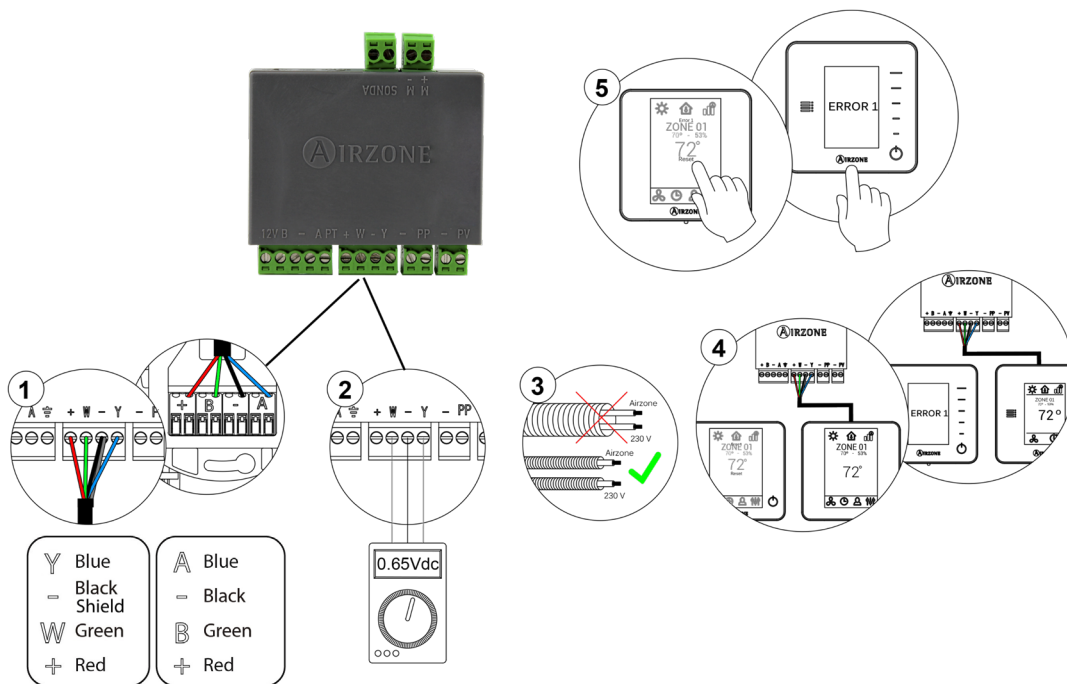

**Fig. 51**

**AZZBSZMxxxC**

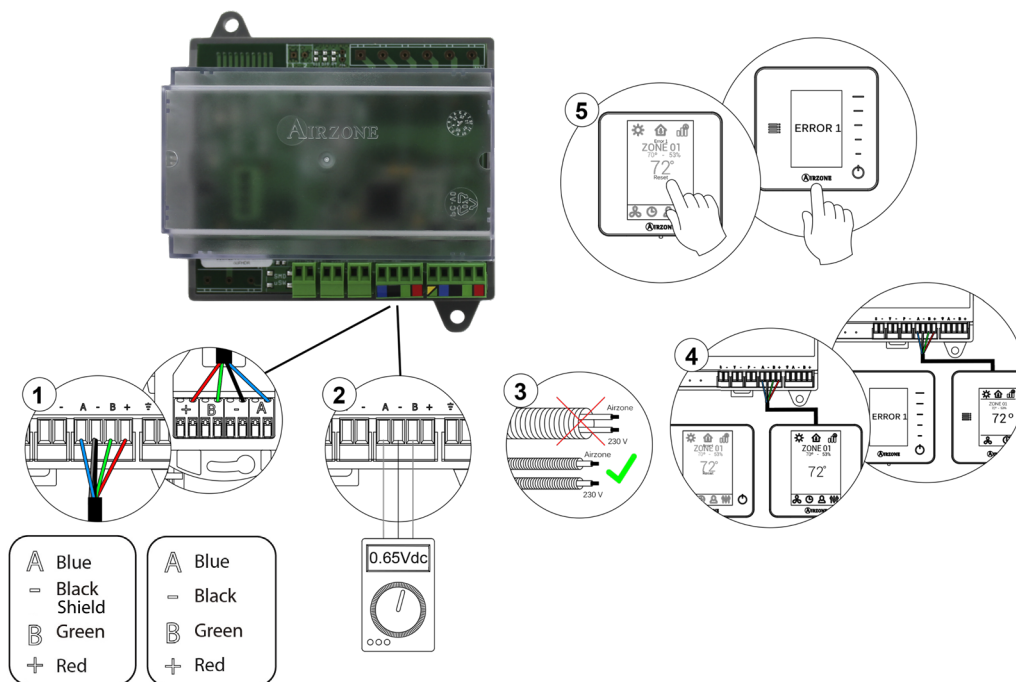

**Fig. 52**

**Error 1: Communication error between wireless controller and zone module (AZZBSDAMPERxxR / AZZBSZMRADR / AZZBSZMxxxR)**

This incident blocks the control of the zone. To solve this incident check:

1. Controller status: Check the signal range of the controller with the module through the Information parameter (see section *Advanced settings, system settings*) or approach the controller to the module if the controller recovers the communication, it is necessary to relocate it as it was out of range.
2. Module status: Correctly powered.

3. Module status: Proper operation of the LED of wireless communication.
4. Restart the zone and re-associate it with the system. To do this, press and hold on **AIRZONE** and restart the start-up configuration process. Note that, if you need to associate wireless devices, the wireless association module must be previously open (from SW1 button or from any controller, pressing *Wireless module* inside *Advanced Settings – Think controllers*).
5. Restart system: If the system is restarted, this error may be displayed in the controllers at the beginning of the process. This message should disappear after around 30 seconds.

### AZZBSDAMPERxxR / AZZBSZMRADR

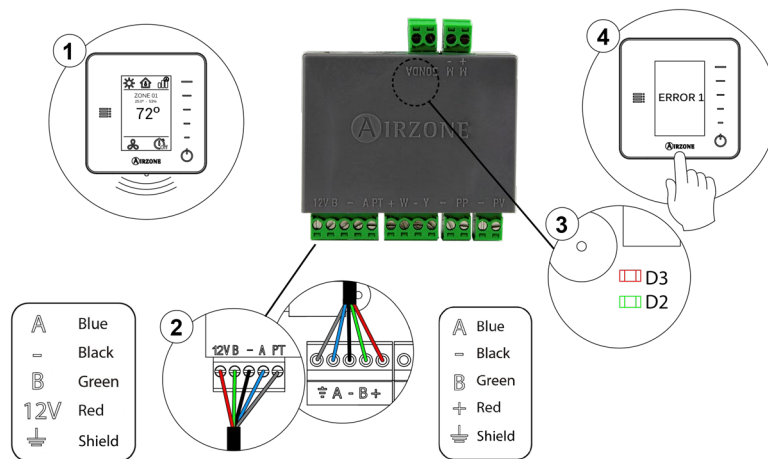

Fig. 53

### AZZBSZMxxxR

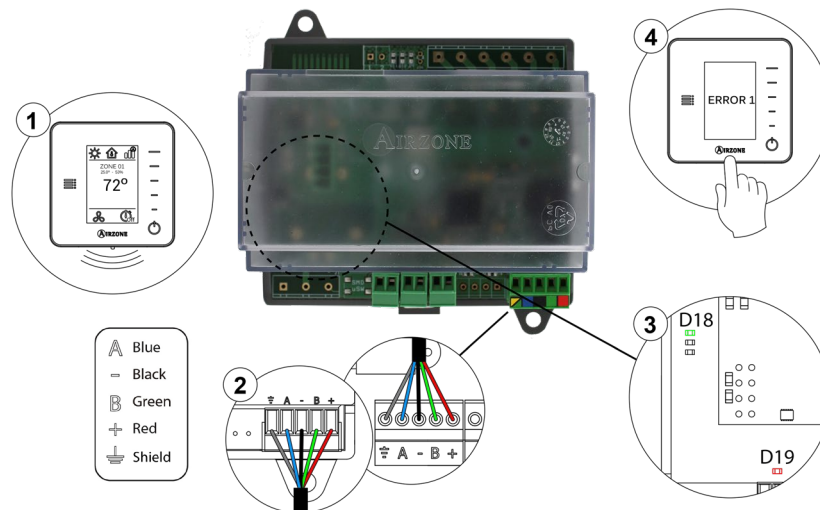

Fig. 54

### Error 2: Communication error between control board and zone module (AZZBSDAMPERxx [C/R] / AZZBSZMRAD [C/R] / AZZBSZMxxx [C/R])

This incident blocks the control of the zone. Check this error is not common to all controllers. If so, verify the proper operation of the main board. To solve this incident check:

1. Control board status: Correctly powered.
2. Control board status: Airzone Connection Bus LEDs are operating properly.
3. Connection: Verify the polarity of the control board and controller connectors.



4. Wiring: Check that the voltage between the poles (A /-) and (B/-) is about 0.65 Vdc.
5. Restart the zone and re-associate it with the system:
  - Blueface controllers: Press on Reset to restart the device. If the error persists, press and hold on and reset the controller. Configure the system.
  - Think controllers: To do this, press and hold on and restart the start-up configuration process.

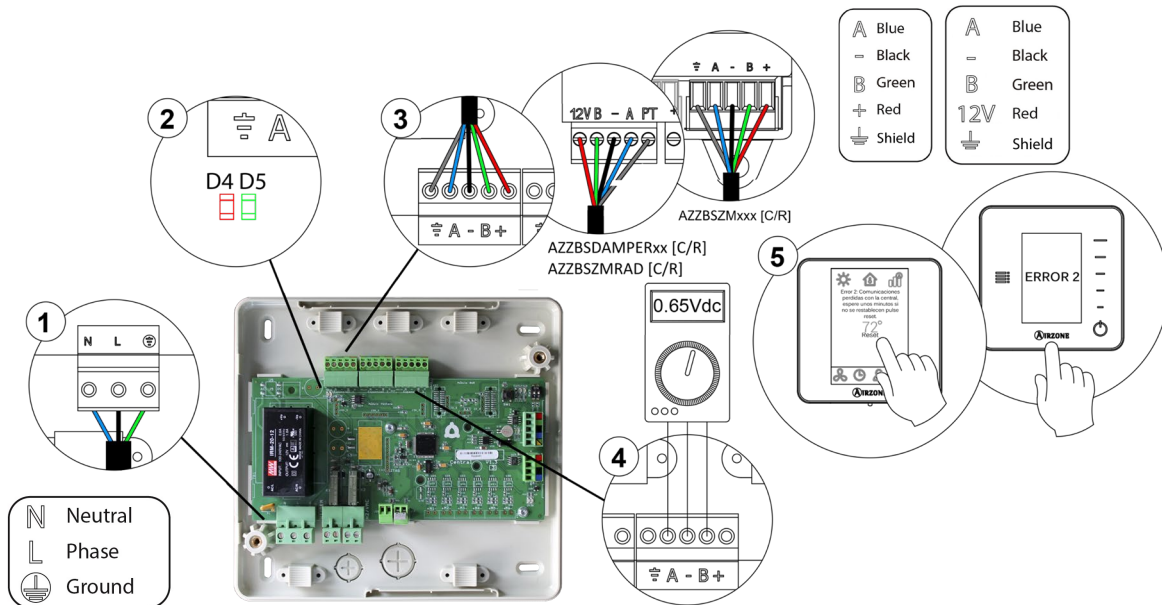

Fig. 55

### Error 3: Motorized element not connected to the actuator output

The system does not detect any motorized element connected to the motor output. Check the state of the connection terminal of the actuator output of the zone module:

1. Status of the connection terminal in the actuator output of the zone module.
2. Disconnect and connect the terminal of the Airzone connection bus.



Fig. 56

**Error 4: Motorized element blocked**

The system detects that the motorized element has an abnormality and blocks the opening-closing movement. Disconnect and connect the Airzone connection bus terminal and check if the error disappears, otherwise, proceed to the replacement of the device or sent it for repair.

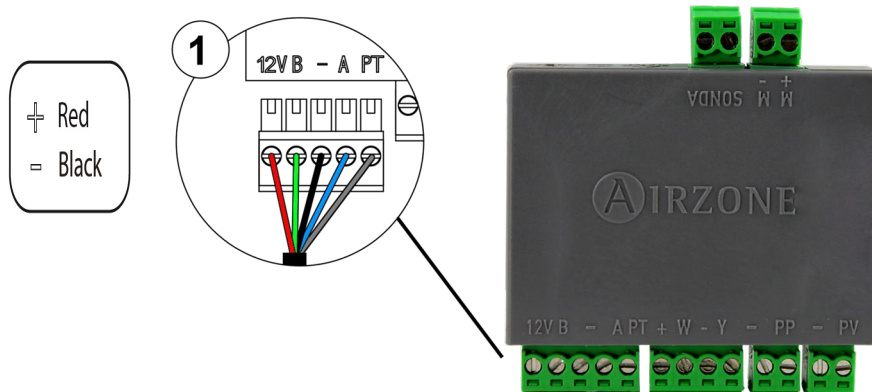

Fig. 57

**Error 5: Temperature probe - Open circuit**

The zone ceases to measure the room temperature; therefore, the zone cannot generate demand. Proceed to replace it of the device or sent it for repair (check if it is produced by the controller's probe or if there is a NTC 10 KOhm Thermistor at the probe output of the zone module).

**Error 6: Temperature probe - Short circuit**

The zone ceases to measure the room temperature; therefore, the zone cannot generate demand. Proceed to replace it of the device or sent it for repair (check if it is produced by the controller's probe or if there is a NTC 10 KOhm Thermistor at the probe output of the zone module).

**Error 9: Gateway-System communication error**

The system loses communication with the AC unit. The system will open all the zones and deactivate the control from the controllers, only allowing the operation of the unit from the controller of its manufacturer. To solve this incident check:

1. Verify the gateway is properly connected to the AC unit port of the control board.
2. Check the status of the LEDs of the gateway. To do this check the self-diagnose section or the technical sheet of the gateway.

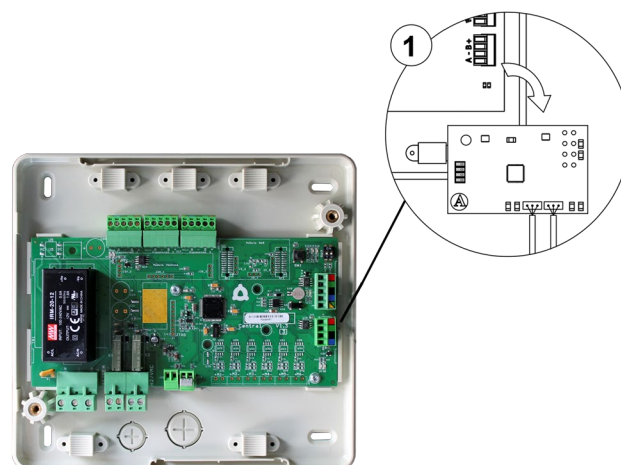

Fig. 58

**Error 10: Communication error between the BACnet Integration Gateway and the system**

The system loses communication with the Airzone BACnet interface. Check that the gateway is properly connected to the automation bus of the Control board.

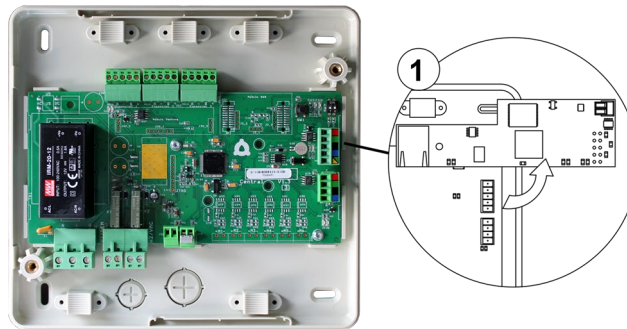

Fig. 59

**Error 11: Communication error between communication gateway and AC Unit**

The system loses communication with the gateway and, therefore, with the AC unit. The system will open all the zones and deactivate the control from the controllers, only allowing the operation of the unit from the controller of its manufacturer. To solve this incident check:

1. Verify if the Air unit is powered. To do this, check the controller of the AC unit is ON.
2. Verify the AC unit operates properly by itself. To do this, disconnect the A/C unit Airzone system and select the unit from the controller from the A/C unit.
3. Connection: Check the polarity and connection of the gateway connectors and the indoor unit. Consult the technical sheet of the gateway in question.
4. Verify the status of the LEDs of the gateway is correct. To do this check the self-diagnose section or the technical sheet of the gateway.

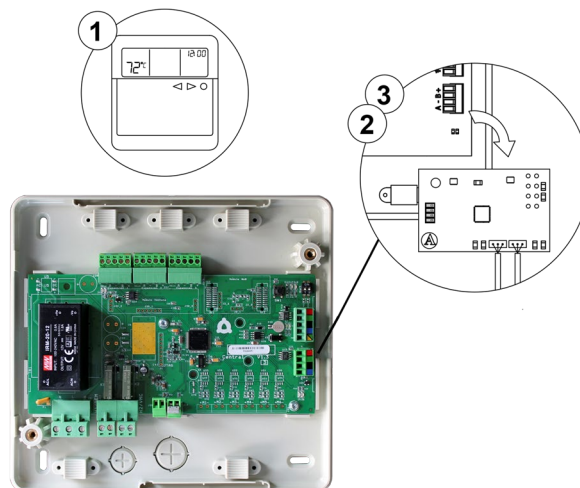

Fig. 60

### Error 12: Communication error between Airzone Cloud Webserver and the system

The system loses communication with the Webserver. Check that the Webserver is correctly connected to the Control board's automation bus.

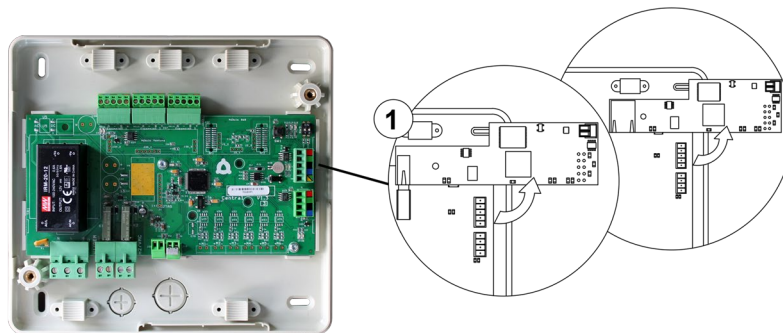

Fig. 61

### Error 13: Communication error between Control board and Relay Radiant Heat Control Module

The device cannot be controlled by the system. To solve this incident check:

1. Status of the module: Correctly powered.
2. Status of the module and the control board: Airzone connection bus LEDs are operating properly.
3. Connection: Check the polarity of the connectors of the control board and the module.
4. Wiring: Check that the voltage between the poles (A /-) and (B/-) is about 0.65 Vdc.

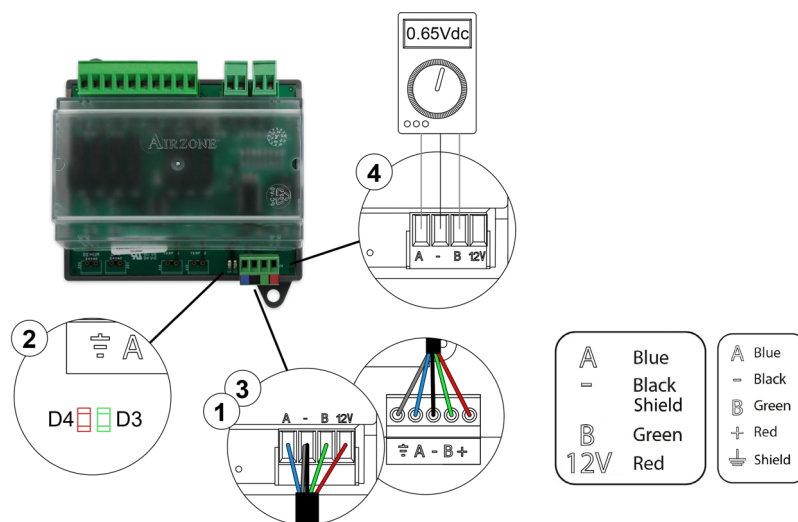

Fig. 62

### AC unit error: Error in the AC unit

Check the type of error in the AC unit controller and follow the instructions provided by the manufacturer.

## LITE CONTROLLERS (AZZBSLITE [C/R])

Lite controllers incorporate LEDs that detect malfunctioning.

**Status LED  blinking purple quickly: Wired Lite Controller- Zone module communication error (AZZBSDAMPERxxC / AZZBSZMRADC / AZZBSZMxxxC)**

This incident blocks the control of the zone. To solve this incident check:

1. Connection: Check the polarity of the connectors of the module and the controller.
2. Wiring: Check that the voltage between the poles (A /-) and (B/-) is about 0.65 Vdc.
3. Wiring: Verify that the module connection bus-controller is not next to low-voltage wiring.
4. Module: Check the correct operation of the module, for this connect another controller and verify that Error 1 does not appear on the screen.
5. Restart the zone and re-associate it with the system.

**Remember:** To reset to factory values of any Lite controller, turn up the microswitch 8 and place the controller on the base again. Press on , the LED will flash green twice when the reset process is completed.

6. Restart system: If the system is restarted, this error may be displayed in the controllers at the beginning of the process. This message should disappear after around 30 seconds.

### AZZBSDAMPERxxC / AZZBSZMRADC

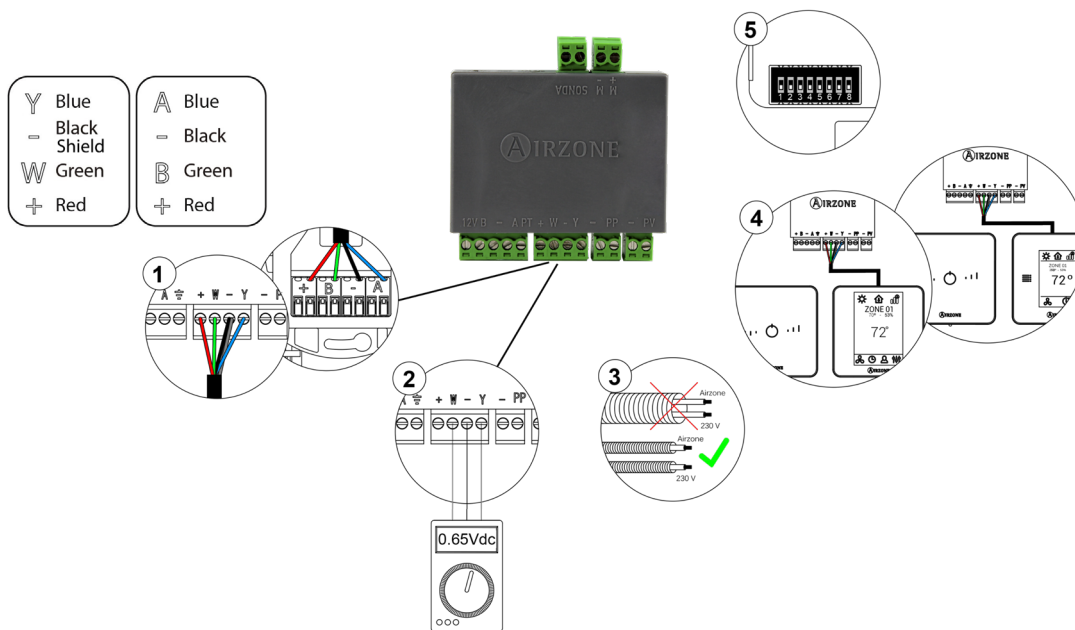
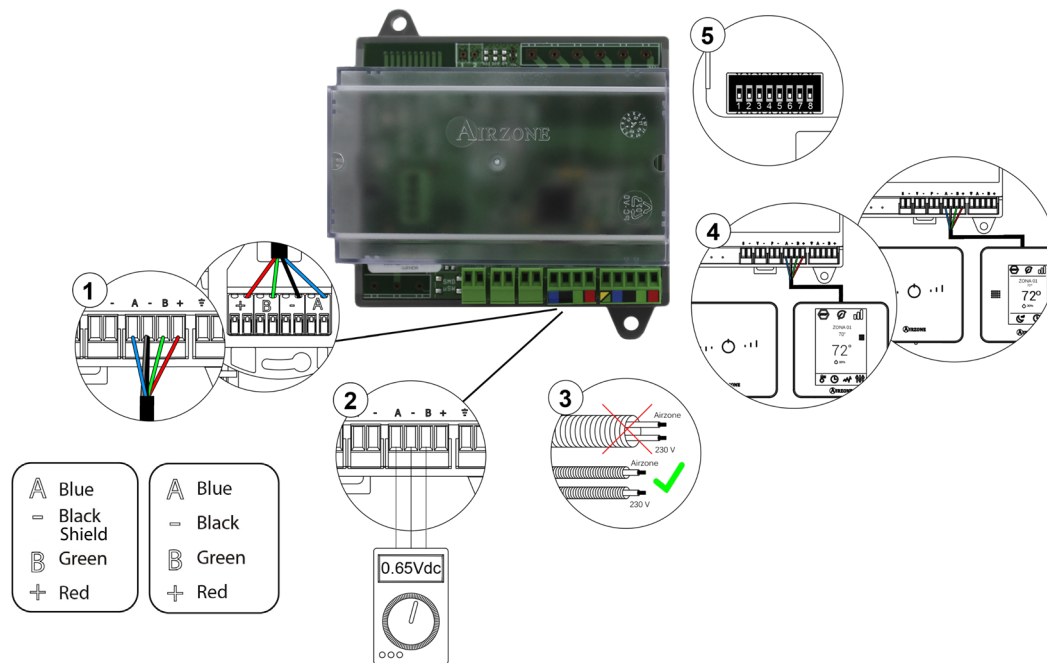

Fig. 63

**AZZBSZMxxxC**



**Fig. 64**

**Status LED blinking purple quickly: Wireless Lite Controller- Zone Module communication error (AZZBSDAMPERxxR / AZZBSZMRADR / AZZBSZMxxxR)**

This incident blocks the control of the zone. To solve this incident check:

1. Controller status: Check the signal range of the controller with the module through the Information parameter from remote zones or approach the controller to the module if the controller recovers the communication, it is necessary to relocate it as it was out of range.
2. Module status: Correctly powered.
3. Module status: Proper operation of the LED of wireless communication.
4. Restart the zone and re-associate it with the system.

**Remember:** To reset to factory values of any Lite controller, turn up the microswitch 8 and place the controller on the base again. Press on , the LED will flash green twice when the reset process is completed.

5. Restart system: If the system is restarted, this error may be displayed in the controllers at the beginning of the process. This message should disappear after around 30 seconds.

**AZZBSDAMPERxxR / AZZBSZMRADR**

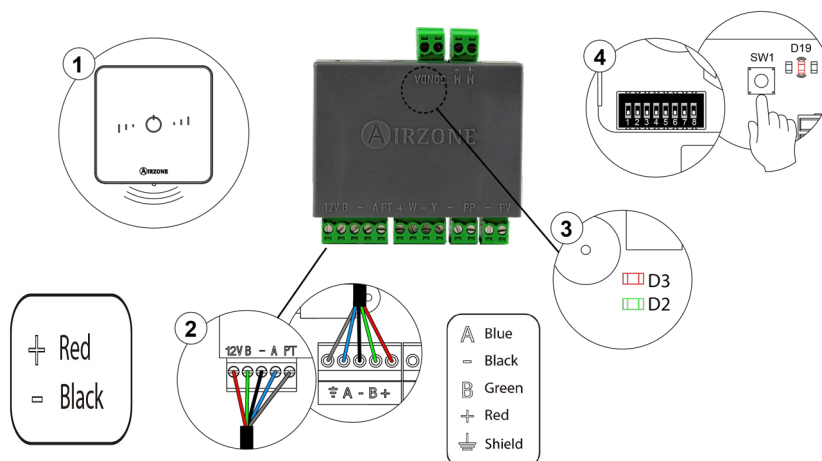

**Fig. 65**

**AZZBSZMxxxR**

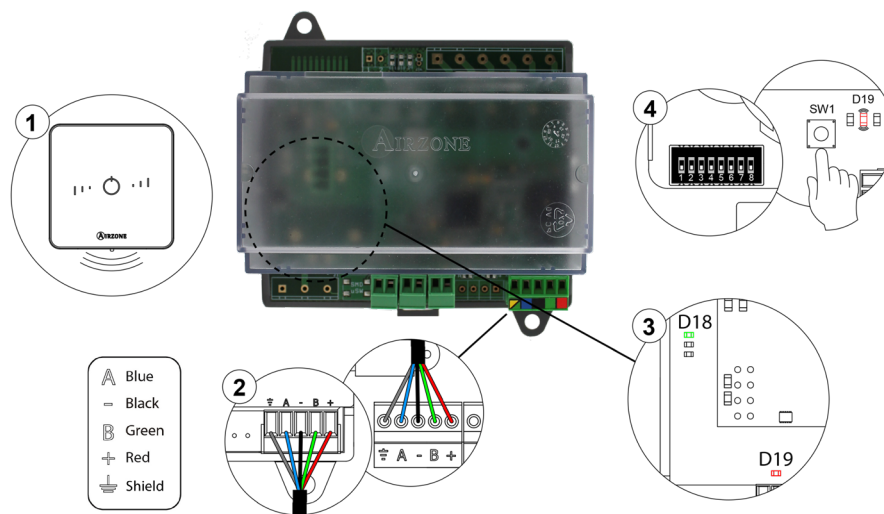

**Fig. 66**

**Status LED blinking red quickly: Zone Module- Control board communication error (AZZBSDAMPERxx [C/R] / AZZBSZMRAD [C/R] / AZZBSZMxxx [C/R])**

This incident blocks the control of the zone. Check that “Error 2” does not appear to all controllers. If so, verify the proper operation of the main board. To solve this incident check:

1. Control board status: Correctly powered.
2. Control board status: Airzone Connection Bus LEDs are operating properly.
3. Connection: Verify the polarity of the control board and controller connectors.
4. Wiring: Check that the voltage between the poles (A /-) and (B/-) is about 0.65 Vdc.
5. Restart the zone and re-associate it with the system.

**Remember:** To reset to factory values of any Lite controller, turn up the microswitch 8 and place the controller on the base again. Press on , the LED will flash green twice when the reset process is completed.

6. Restart system: If the system is restarted, this error may be displayed in the controllers at the beginning of the process. This message should disappear after around 30 seconds.

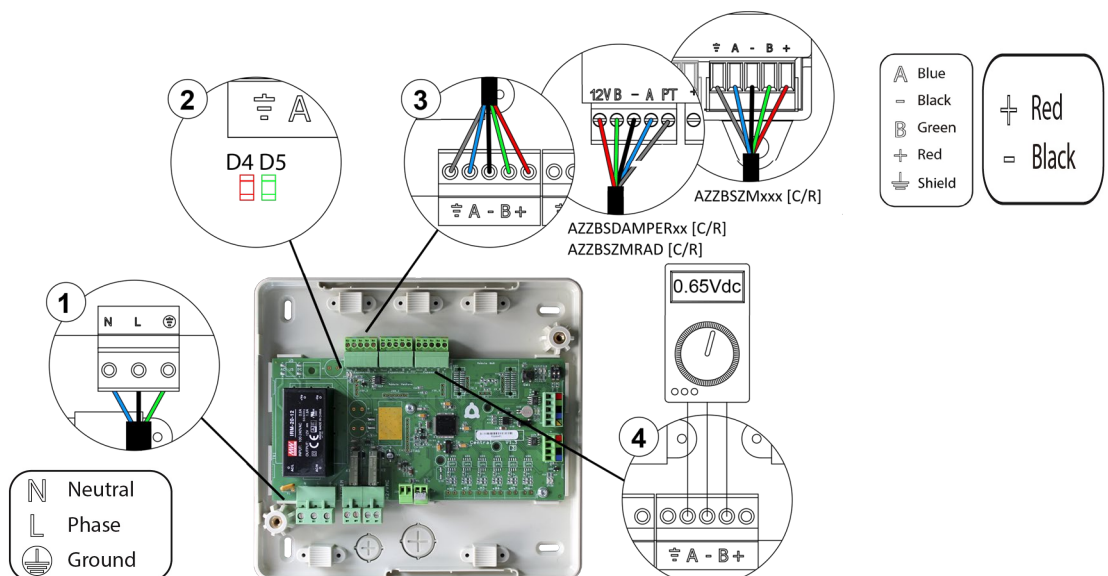

**Fig. 67**

## COMMUNICATION GATEWAYS (AZZBSGTXXX)

The communication gateways incorporate LEDs that detect unusual operations. Check the distribution of the LEDs in the data sheet supplied along with the product.

### 1) Power LED D1: Off

- Check the air conditioning unit is powered.
- Check the connections between the gateway and the AC unit and between the gateway and the controller of the AC unit (if applicable).
- Verify the status of the connectors in the wiring connecting gateway-AC unit and/or gateway-AC controller.
- Verify the gateway is properly connected to the AC unit port of the control board.

### 2) Microprocessor operation LED D2: Not blinking

- Contact the Airzone after-sales department, the microcontroller does not operate properly.

### 3) Communication LEDs D3 and D4: Not blinking

- Verify the gateway is properly connected to the AC unit port of the control board.

### 4) LEDs D5 and D6 of communication with the indoor unit: Not blinking

- Check gateway-AC unit connection.

### 5) LEDs D7 and D8 of communication with the indoor unit: Not blinking

- Check the Gateway-AC unit controller connection.

## ETHERNET/WIFI CLOUD WEBSERVER (AZZBSWSCLOUD [C/R])

Airzone Cloud Webservers incorporate LEDs that detect malfunctioning.

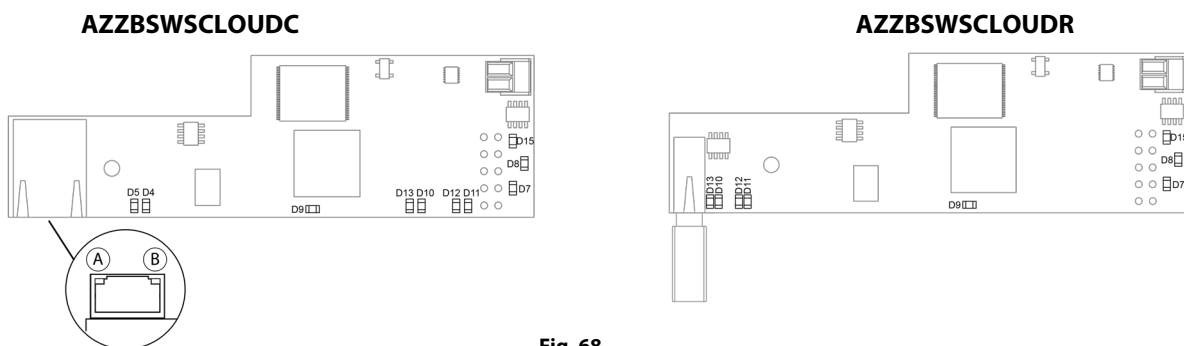

Fig. 68

Meaning				
D5	(A)	Ethernet connected	Blinking	Green
D4	(B)	Ethernet activity	Blinking	Yellow / Red
D7		Data transmission from domotic bus (input and output)	Blinking	Red
D8		Data reception from domotic bus (input and output)	Blinking	Green
D9		Microswitch performance	Blinking	Green
D10		Connected to the Internet	Blinking	Green
D11		Network data transmission	Blinking	Red
D12		Network data reception	Blinking	Green
D13		Configured as IP address through DHCP	On	Red
		Configured as Fixed IP address	Off	
D15		Power supply	Steady	Red



### BACNET INTEGRATION GATEWAY (AZZBSBACNETG)

BACnet integration gateways incorporate LEDs that detect malfunctions.

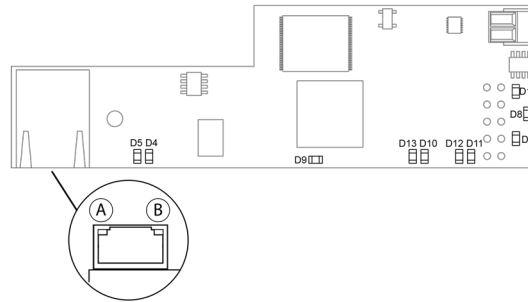

Fig. 69

Meaning			
D5	(A)	Ethernet connected	Blinking Green
D4	(B)	Ethernet activity	Blinking Yellow / Red
D7		Data transmission from automation	Blinking Red
D8		Data reception from automation bus	Blinking Green
D9		Microswitch performance	Blinking Green
D10		Connected to the Internet	Blinking Green
D11		Network data transmission	Blinking Red
D12		Network data reception	Blinking Green
D13		Configured as IP address through DHCP	On Red
		Configured as Fixed IP address	Off Red
D15		Power supply	Steady Red

### LUTRON INTEGRATION GATEWAY (AZZBSLUTRONG)

Lutron integration gateways incorporate LEDs that detect malfunctions.

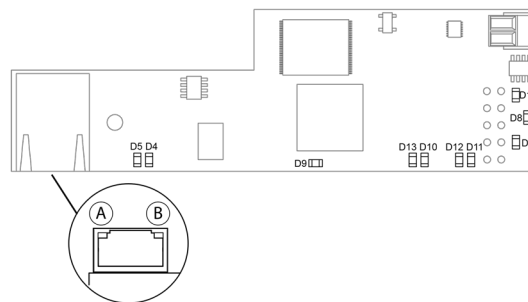
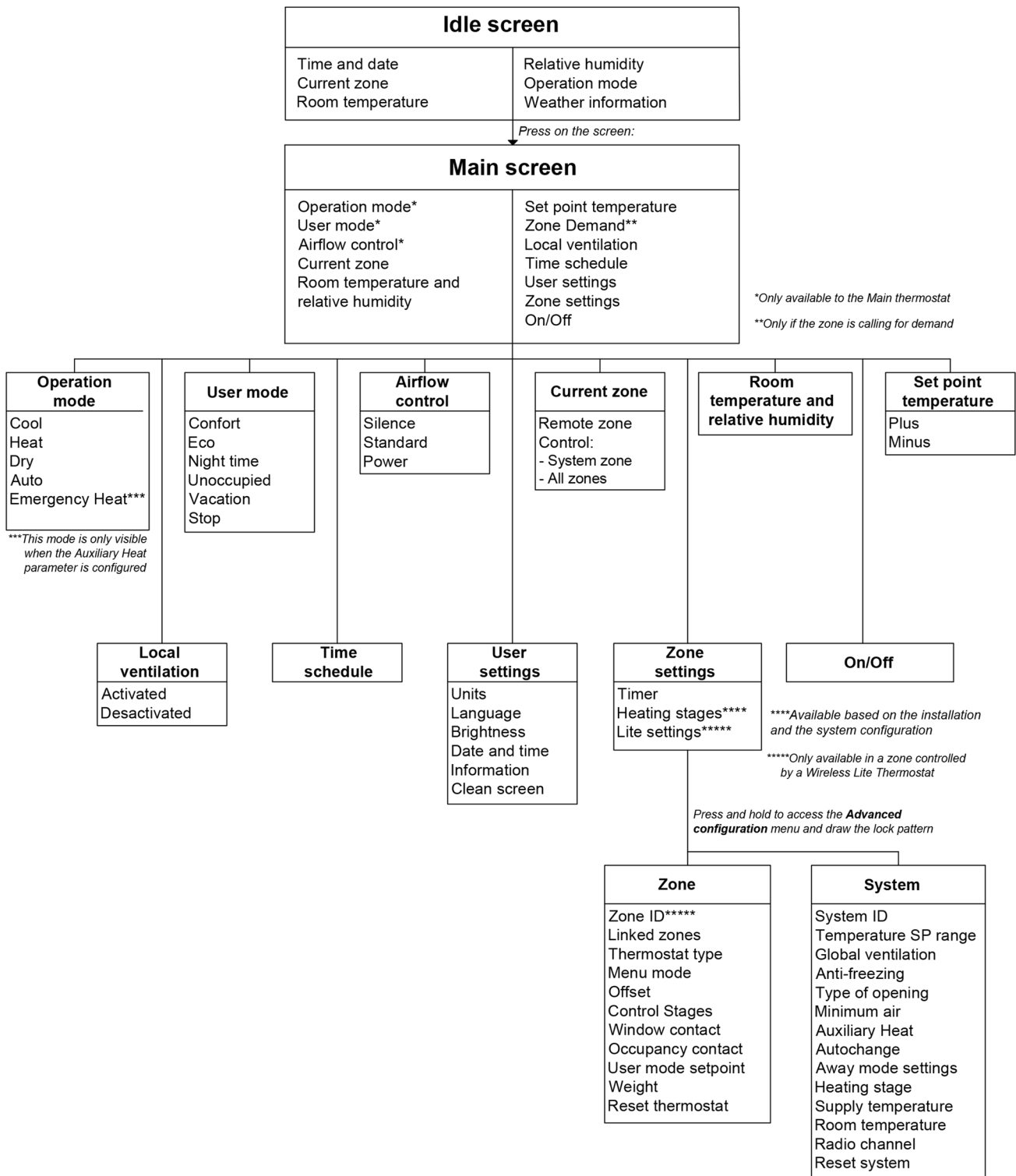

Fig. 70

Meaning			
D5	(A)	Ethernet connected	Blinking Green
D4	(B)	Ethernet activity	Blinking Yellow / Red
D7		Data transmission from automation	Blinking Red
D8		Data reception from automation bus	Blinking Green
D9		Microswitch performance	Blinking Green
D10		Connected to the Internet	Blinking Green
D11		Network data transmission	Blinking Red
D12		Network data reception	Blinking Green
D13		Configured as IP address through DHCP	On Red
		Configured as static IP address	Off Red
D15		Power supply	Steady Red

# NAVIGATION TREES

## BLUEFACE CONTROLLER NAVIGATION TREE



# THINK CONTROLLER NAVIGATION TREE

**Remember:** Use to confirm and for going back if browsing submenus.

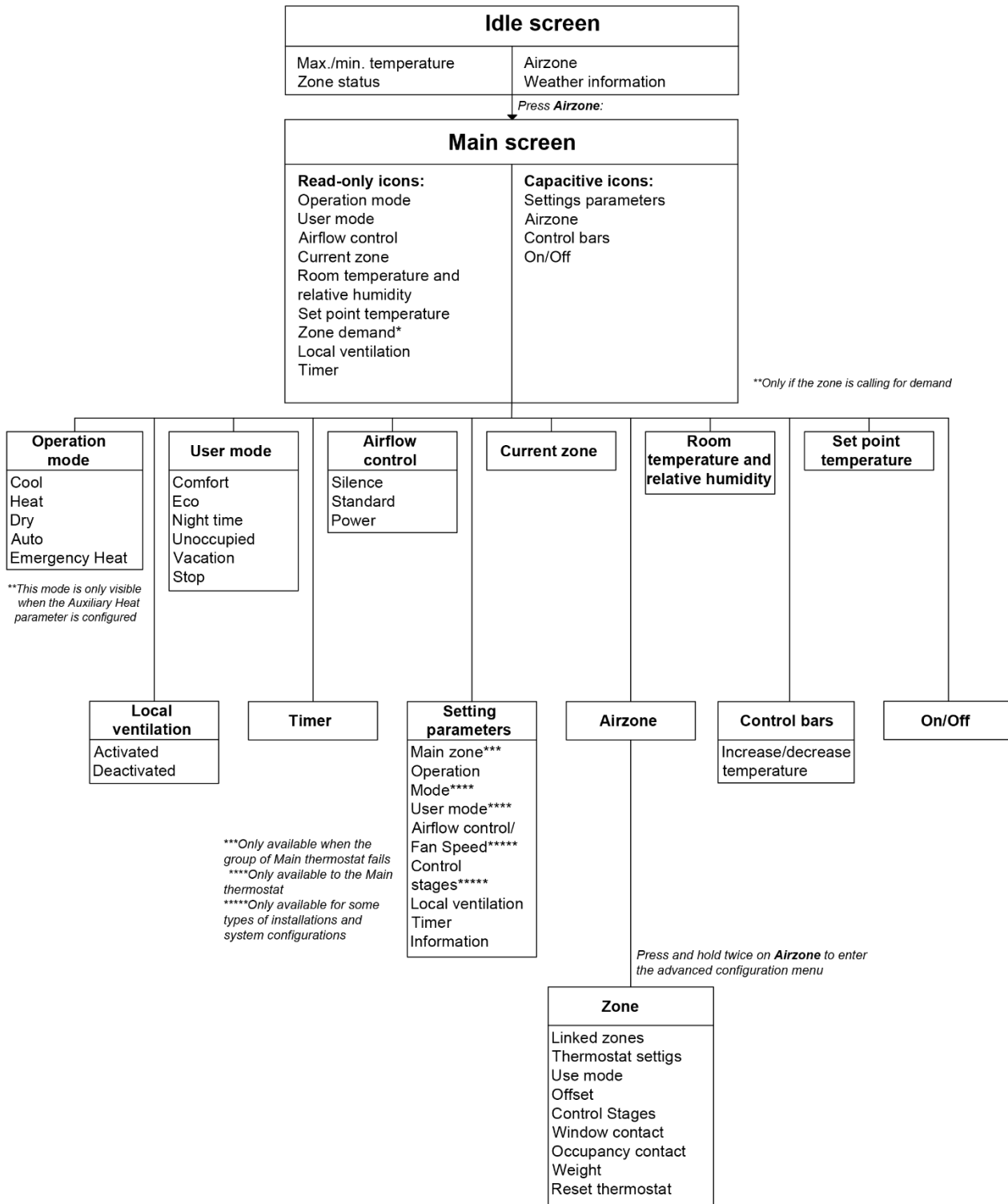



Parque Tecnológico de Andalucía

C/ Marie Curie, 21 – 29590

Campanillas – Málaga - España

Phone: +34 900 400 445

Fax: +34 900 400 446

<http://www.myzone.airzoneusa.com>



MIAZZBSEN104