

REHP Series

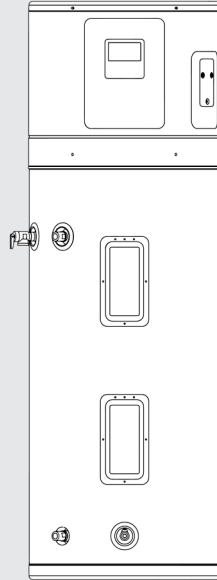

Electric Heat Pump Water Heater

Installation and Operation Manual

Rinnai

 **WARNING**

DO NOT destroy this manual. Please read the manual and labels thoroughly located on the water heater before you install, operate, or service it. Consult your manufacturer or your dealer for details concerning your product. The illustration on the front cover is for reference only.

Contents

1. Welcome	4
1.1 To the Installer and Consumer	4
1.2 For Your Records	4
2. Safety	5
2.1 Read the Safety Information	5
2.2 Safety Precautions	5
2.3 Relief Valve Warnings	7
2.4 Coin Cell battery Warnings	8
2.5 Additional Precautions	9
3. Understanding Heat Pump Water Heater	10
3.1 Operating Principle	10
3.2 System Schematic	10
4. About the Water Heater	11
4.1 Top View	11
4.2 Front View	11
4.3 Components	12
4.4 General Specification	12
4.5 Included Items with Unit	13
4.6 Accessories	13
5. Installation Instructions	14
5.1 Local Installation Regulations	14
5.2 Additional Clearances	14
5.3 Recommended Locations for Maximum Energy Saving (Not Ducted)	15
5.4 Inspect Shipment	16
5.5 Positioning the Heat Pump	16
5.6 Thermal Expansion	17
5.7 Water Supply Connections	17
5.8 Condensate Drain	18
5.9 Typical Installation	19
5.10 Relief Valve	19
5.11 To Fill the Water Heater	20
5.12 Electrical Connection	20
5.13 Insulation Blanket	23
5.14 Hot and Cold Pipe Insulation Installation	24
5.15 Ducting Requirement	24
6. Operating Instruction	25
6.1 Start-Up Information	25
6.2 Operation	26
6.3 Engineering Channel	33

7. Care & Cleaning	35
7.1 Routine Preventive Care	35
7.2 Draining the Water Heater	35
7.3 Element Heater	35
7.4 Air Filter Maintenance	36
7.5 Condensate Drain Maintenance	36
7.6 TCO Switch Check	36
7.7 Vacation and Extended Shut-Down	36
7.8 Anode Rod Maintenance	36
8. Troubleshooting Tips	37
8.1 Before you Call for Service	37
8.2 Troubleshooting	37
8.3 Performance Data	38
8.4 Error Codes	39
9. Customer Service	42
9.1 CTA Module Set-Up	42
9.2 Demand Response (CTA-2045) Installations	43
9.3 Replacement Parts	44
9.4 Thermal Cut-off Reset Instructions	46
9.5 Wiring Diagram	47
9.6 Warranty	48

1. Welcome

Thank you for purchasing a Rinnai Electric Heat Pump Water Heater. Before installing and operating this water heater, please read these instructions completely to familiarize yourself with the water heater's features and functionality.

1.1 To The Installer and Consumer

This manual offers the installer essential recommendations and basic instructions for correctly installing and adjusting the water heater. It provides comprehensive information on the features, operation, safety precautions, maintenance, and troubleshooting procedures for the owner/operator. Additionally, a replacement parts list is included in this manual.

It is imperative for the owner/operator to thoroughly read and comprehend the instructions to ensure proficient adjustment and operation of the water heater. If there is any difficulty in understanding the instructions, it is advised to seek professional assistance.

For any inquiries regarding service, warranty, and maintenance matters not addressed in these instructions, please direct them to the seller from whom you purchased the product.

1.2 For Your Records

Fill out this section for your records.

Date Purchased:

Model number:

Serial number:

Check the rating plate label located on the front of water heater for model number and serial number.

Proof of the original purchase date is needed to obtain service under the warranty.

2. Safety

WARNING

Schedule an appointment with a trained and qualified professional to install your water heater. Incorrect installation, operation, or service can damage the water heater, your house and other property, and present risks including fire, scalding, electric shock, and explosion, causing serious injury or death. Preventative care by owner can maximize the life of the water heater. Please refer to CARE & CLEANING section and TROUBLESHOOTING TIPS section. This may prevent you from making a service call for your appliance.

2.1 Read the Safety Information



Identify the safety alert symbol, recognizing it as a sign of important safety information. This symbol serves to alert you to potential hazards that pose a risk of harm or injury to you and others.

All safety messages will follow the safety alert symbol and either the word “DANGER”, “WARNING”, “CAUTION” or “NOTICE”.

DANGER

Indicates an imminently hazardous situation which, if not avoided, will result in personal injury or death.

WARNING

Indicates an imminently hazardous situation which, if not avoided, will result in personal injury or death.

CAUTION

Indicates a potentially hazardous situation which, if not avoided, could result in minor or moderate injury. It may also be used to alert against unsafe practices.

NOTICE

Attention is called to observe a specified procedure or maintain a specific condition.

2.2 Safety Precautions

Prioritize your safety and that of others. This manual and your water heater contain crucial safety messages. Adhere to all safety instructions.

DANGER SCALDING RISK

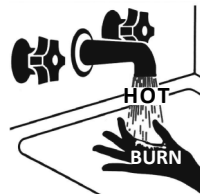

Water temperatures over 125° F (52° C) can cause severe burns or scalding resulting in death.

Table 1
Time/Temperature Relationship in Scalds

Temperature	Time To Cause Serious Burns
120°F (49°C)	More than 5 minutes
125°F (52°C)	1 1/2 to 2 minutes
130°F (54°C)	About 30 seconds
135°F (57°C)	About 10 seconds
140°F (60°C)	Less than 5 seconds
145°F (63°C)	Less than 3 seconds
150°F (65°C)	About 1 1/2 seconds
155°F (68°C)	About 1 second

DANGER ELECTRIC SHOCK



Contact with the electrical parts in the junction box, behind the junction box cover and behind electric heater cover can result in severe injury or death from the electrical shock.

- Disconnect power by opening the circuit breaker or removing the fuses before installing or servicing.
- Use a non-contact circuit tester to confirm that power is off before working on or near any electrical parts.
- Replace the junction box cover and access doors after servicing.

WARNING Lifting Risk



The water heater is heavy. Follow these precautions to reduce the risk of property damage, injuries from lifting or impact injuries from dropping the water heater

- Use at least two people to lift the water heater.
- Be sure you both have a good grip before lifting.
- Unit is top heavy, use an appliance dolly (with strap) to move the water heater.

WARNING Temperature Setting

The water heater interface regulates the temperature of the water. For safety compliance, the temperature of the water heater was factory preset at 120°F (49°C) before it was shipped.

- See the *Figure 1* for the water default temperature setting and refer to section 6.2, page 25 in this manual for details on adjusting it.

Figure 1

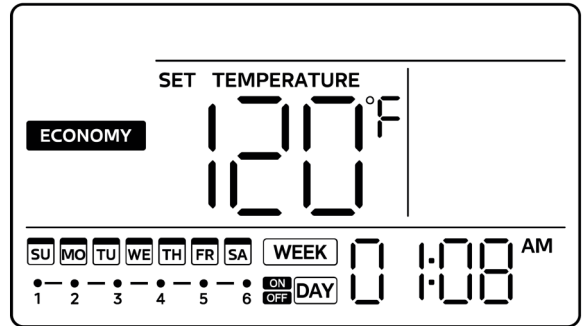

WARNING

As the owner/operator, it is essential to thoroughly read and adhere to the warning instructions provided on the label *Figure 2*, which is also located on the water heater.

Figure 2



Scalding Label

Warning Label

NOTICE

Mixing valves are recommended to lower water temperature at specific points of use by blending hot and cold water within branch water lines.

- It is recommended to install a mixing valve that meets the requirement in ASSE 1017, the Standard for Temperature Actuated Mixing Valves for Hot Water Distribution Systems.

- For more detailed information, please refer to Section 9.2, page 42 for further assistance, reach out to a licensed plumber or your local plumbing authority.
- In demand response applications, a thermostatic mixing valve in compliance with ASSE 1017 must be placed on the hot water supply line, following all installation instructions provided by the manufacturer.

2.3 Relief Valve Warnings

Safety Devices

The water heating system is equipped with temperature sensors, overheat sensors, switches, Drain valve, and a Temperature & Pressure Relief (T&P) valve. It is essential that these components are not tampered with or removed. The operation of the water heating system should only occur when each of these devices is correctly installed and functioning.

Temperature & Pressure Relief (T&P) Valve

Please note that this valve is located near the top of the water heater close to hot water outlet and is essential for safe operation. A nationally recognized testing laboratory maintains periodic inspection of the valve production process and certifies that it meets the requirements for Relief Valves for Hot Water Supply Systems, ANSI Z21.22.

WARNING

- DO NOT tamper with or remove safety devices.
- DO NOT operate the water heater unless all safety devices are fitted and in working order.
- DO NOT block or seal the T&P Valve and drainpipe.
- DO NOT connect other plumbing to the T&P plumbing; it must go directly to a suitable open drain.

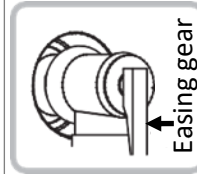

To operate T&P valve, lift easing gear until water flows from drain line. (Lower gear gently!)

WARNING

- NEVER block the outlet of the T&P valve or its drain line for any reason. The T&P valve MUST be operated at least every 6 months to remove lime deposits and verify that it is not blocked. Failure to do this may result in the water heater failing.
- If the valve does not discharge water when the easing gear is opened or does not seal again when the easing gear is closed, contact qualified and trained professional to replace the valve. The T&P valve is not serviceable, it MUST be replaced.

WARNING

- NEVER replace the T&P valve with one which has a higher-pressure rating than is specified for your water heater.
- The pressure rating of the relief valve used must not exceed 150 PSI, the maximum working pressure of the water heater as marked on the rating plate.

WARNING

Prior to installing or operating the water heater, thoroughly read and comprehend the entire Manual. Taking the time to do so can potentially save you both time and expenses. Pay special attention to the Safety Instructions outlined in the manual, as neglecting these precautions could lead to severe bodily harm or fatal consequences. If you encounter difficulties understanding the instructions or have any questions, cease the installation or operation, and seek assistance from a qualified service technician or your local electric utility.

2.4 Coin Cell Battery Warnings

⚠ WARNING

- **INGESTION HAZARD:** This product contains a button cell or coin battery.
- **DEATH** or serious injury can occur if ingested.
- A swallowed button cell or coin battery can cause **Internal Chemical Burns** in as little as **2 hours**.
- **KEEP** new and used batteries **OUT OF REACH** of **CHILDREN**
- **Seek immediate medical attention** if a battery is suspected to be swallowed or inserted inside any part of the body.



⚠ WARNING

- Remove and immediately recycle or dispose of used batteries according to local regulations and keep away from children. Do NOT dispose of batteries in household trash or incinerate.
- Even used batteries may cause severe injury or death.
- Call a local poison control center for treatment information.
- Battery type: CR2032
- Battery nominal voltage: 3.0V
- Non-rechargeable batteries are not to be recharged.
- Do not force discharge, recharge, disassemble, heat about 140°F (60°C) or incinerate. Doing so may result in injury due to venting, leakage or explosion resulting in chemical burns.
- Ensure the batteries are installed correctly according to polarity (+ and -).
- Do not mix old and new batteries, different brands of batteries, such as alkaline, carbon-zinc, or rechargeable batteries.
- Remove and immediately recycle or dispose of batteries from equipment not used for an extended period of time according to local regulations.
- Always completely secure the battery compartment. If the battery compartment does not close securely, stop using product, remove the batteries, and keep them away from children.

2.5 Additional Precautions

1. Request the installer to demonstrate the circuit breaker's location and how to switch off the power if necessary. Switch off the circuit breaker under circumstances such as overheating, fire, flooding, physical damage, or if the TCO (thermal cut-off) fails to deactivate.
2. Prior to installing or operating the water heater, thoroughly review this manual.
3. Utilize this appliance solely for its intended purpose as outlined in the Manual.
4. Ensure that your appliance is correctly installed in compliance with local codes and the accompanying installation instructions.
5. DO NOT attempt to repair or replace any component of the water heater unless explicitly recommended in this manual; seek the assistance of a qualified technician for all other servicing.
6. DO NOT attempt to repair or replace the compressor, refrigerant, or any component associated with the sealed refrigerant system.
7. DO NOT activate the electrical supply or operate the water heater unless it is entirely filled with water.

WARNING

Before commencing maintenance, ensure that all power to the unit is disconnected. Neglecting to do so may lead to electrical shock, causing significant personal injury or even death.

WARNING

FLAMMABLE CONTENTS UNDER PRESSURE.

The compressor is a non-serviceable component. Arcing of the compressor wiring terminals could lead to the release of pressurized refrigerant and oil, potentially causing ignition and resulting in severe bodily injury, severe burns, or even death.

Refrigerant

The Water Heater comes pre-charged with an environmentally friendly refrigerant, R134A, which is free from chlorine. This refrigerant has a zero-ozone depletion potential.

3. Understanding Heat Pump Water Heater

3.1 Operating Principle

The electric heat pump operates in a manner opposite to that of a refrigerator. It extracts heat from the surrounding outside air and transfers it into the water, using electricity solely for system operation. This results in significantly reduced energy consumption compared to using an electric element hot water system alone. The efficiency of the heat pump system is enhanced in warmer climates.

The heat pump unit features a highly efficient micro-channel heat exchanger wrapped around the inner cylinder to optimize thermal conductivity. A temperature sensor in the tank regulates the heat pump's operation to achieve the desired water temperature.

During periods when ambient weather conditions are unfavorable for the heat pump operation or during peak water demand, the electric element heater takes over to ensure a continuous supply of hot water.

3.2 System Schematic

Illustrated in *Figure 3*, the sealed system within the apparatus is charged with refrigerant. This refrigerant undergoes evaporation at low temperatures, extracting heat from the surrounding air. Within the evaporator, the refrigerant transitions from a liquid to a gaseous state. Subsequently, a compressor elevates the pressure and temperature of the gaseous refrigerant. The energy for compression, sourced from electricity, is indirectly converted into heat and discharged to the downstream microchannel (condenser). At this stage, the refrigerant indirectly imparts latent heat to the water within the Domestic Hot Water (DHW) tank, experiencing a phase change back to a liquid state. The liquid refrigerant is then directed to a filter drier, followed by an expansion valve that diminishes the prevailing pressure. The refrigerant is subsequently guided back to the evaporator, initiating the cycle again.

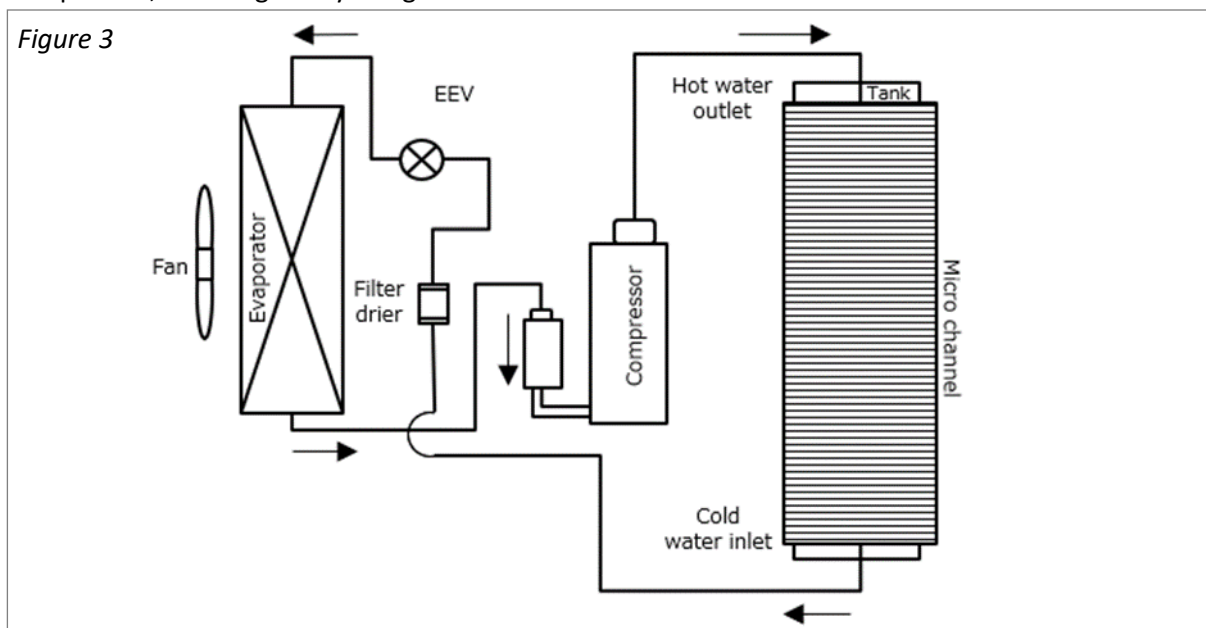

4. About the Water Heater

Topics in this section

- Top View
- Front View
- Components
- General Specifications
- Included Items with Unit
- Accessories

The Rinnai Electric Heat Pump Water Heater is designed for indoor installation only. The appliance extracts heat from the ambient air and provides it to the water in the DHW tank with added electric power. The amount of electric energy and time required to heat-up the DHW depends on the temperature and humidity of the ambient air.

4.1 Top View

Figure 4

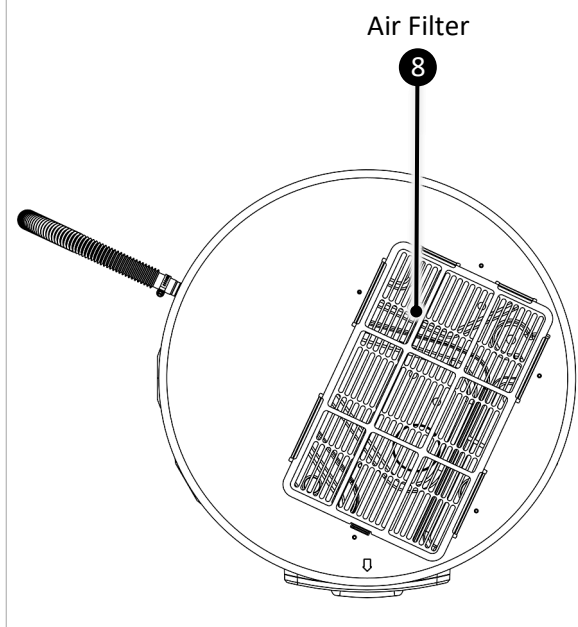

4.2 Front View

Figure 5

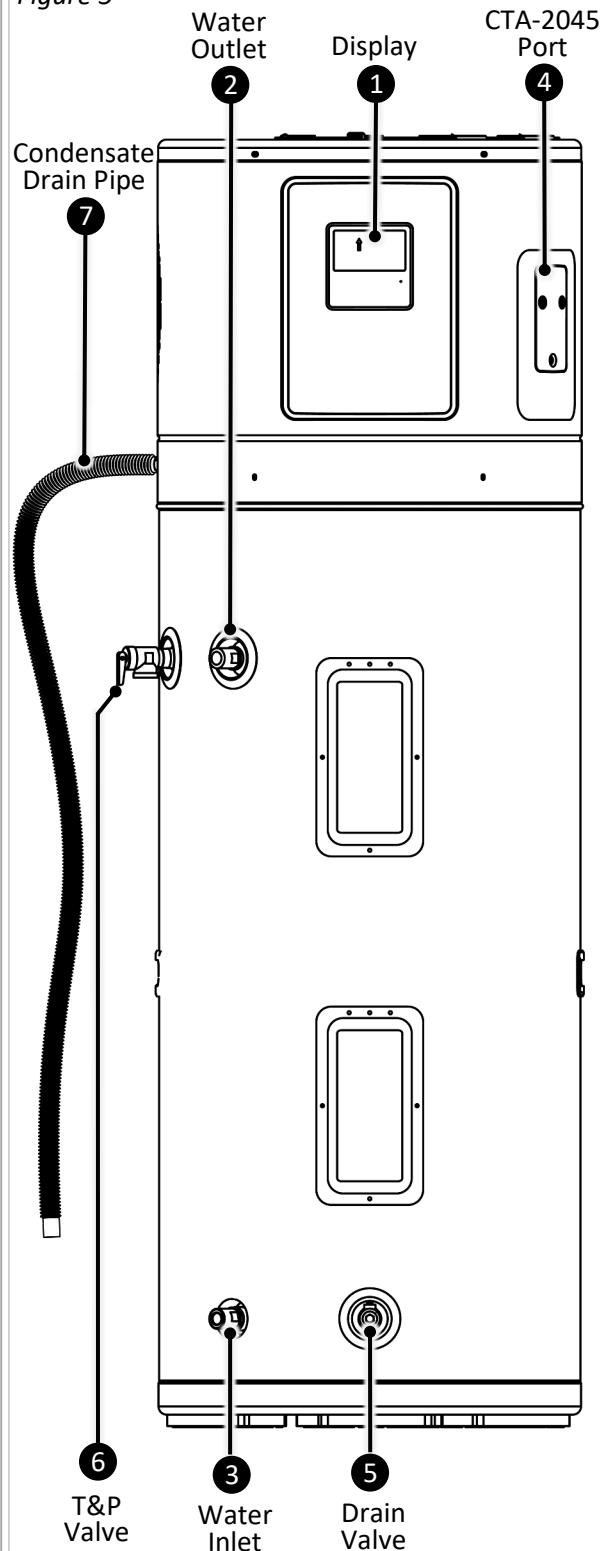

4.3 Components

Listed below are descriptions of heat pump components. Refer to the previous page for component illustration.

Table 2

Item	Name	Description
①	Display	The appliance is equipped with 4.1" screen with user friendly interface and touch panel controller to perform operations.
②	Water Outlet	Hot water outlet with 3/4" MNPT fitting.
③	Water Inlet	Cold water in with 3/4" MNPT fitting.
④	CTA2045 Port	CTA2045 compliant module can be connected to the water heater through this port.
⑤	Drain Valve	Provides easy access to drain the tank during maintenance.
⑥	T&P Valve	Automatically releases water when the pressure or temperature in the tank exceeds safety levels.
⑦	Condensate Drain Pipe	A flexible 5.2 ft long pipe provided with unit to drain condensate.
⑧	Air Filter	Washable air filter filters and eliminates debris from entering.

4.4 General Specifications

Table 3

	Model	REHP Series (for all models)
	Total Unit Wattage (Input)	5000 W
	Installation Type	Indoor
	Power Supply	208 - 240 V
	Electric Breaker Size	30 Amps
	Maximum Current	21.5 Amps
	Refrigerant Type	R134a
	Refrigerant Circuit Max Pressure	150 PSI (1034 KPa)
	Operating Ambient Temp. for Heat Pump	37~108°F (3~42°C)
	Operating Ambient Temp. for Heating Element	5~115°F (-15~46°C)
	Ingress Protection	IP21
	Hot Outlet and Cold Inlet Water Connections	3/4" MNPT
	Condensate Drain Connection	3/4" Male Barb Fitting
	Temp & Pressure Valve Pressure Rating	150 PSI (1034 KPa)
	Temp & Pressure Valve Temperature Rating	210°F (99°C)
	Certifications	NEEA, AHRI, ANSI, and UL
	Energy Star Certified	Yes
	Warranty	Tank & All Other Parts & Components: 10 Years. Reasonable Labor: 1 Year. See Section 9.6, page 48 for Complete Details

***Refer to 80000224 (Electric Heater Pump Water Heater Specification Sheet) for detailed specifications and unit dimensions.**

4.5 Included Items with Unit

Carefully unpack your water heater and verify the following items are included/preinstalled. If any items are damaged or missing, contact your local dealer/distributor. Do not attempt to use any item that appears damaged.

Figure 6

T&P VALVE



PART #: 107000677

DRAIN VALVE



PART #: 107000678

DRAINAGE PIPE

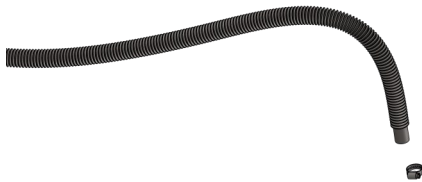

PART #: 107000674

DOCUMENTATION

- Installation and Operation Manual (this manual)

4.6 Accessories

The following optional accessories are available for the Rinnai Electric Heat Pump Water Heater.

Figure 7

EHPWH DUCTING KIT



PART #: 103000120

EHPWH LEAK KIT



PART #: 103000119

5. Installation Instructions

5.1 Local Installation Regulations

Installation of this water heater must adhere to these instructions, local codes, utility codes, and utility company requirements. In the absence of local codes, compliance with the latest edition of the National Electrical Code is mandatory. This code can be obtained from various local libraries or purchased from the National Fire Protection Association at Battery March Park, Quincy, MA 02269, in the form of the ANSI/NFPA 70 booklet.

For Canadian installations, reference to CSA22.1. A copy can be acquired from the Canadian Standards Association at 5050 Spectrum Way, Mississauga, ONT L4W 5N6.

Location

Identify a clean, dry location for your water heater and position it as close as possible to the area with the highest demand for heated water. It's important to note that extended, uninsulated hot water lines can result in energy and water wastage. Ensure that the water heater is situated in a way that allows easy removal of the heating element cover for inspection and servicing, such as element removal or control checks. Protect the water heater and water lines from freezing temperatures; avoid installing the water heater in outdoor, unprotected areas. Verify that the floor beneath the water heater is robust enough to support the weight of the filled water heater.

CAUTION

The water heater should not be located in an area where leakage of the tank or connections will result in damage to the area adjacent to it or to lower floors of the structure. Where such areas cannot be avoided, it is recommended that a suitable drain pan, adequately drained, be installed under the water heater.

NOTICE

Insufficient ventilation in confined spaces during installation may result in higher power consumption for the unit. It is advisable to install the water heater in locations where ambient temperature is more than 37.4°F (3°C) and less than 107.6°F (42°C).

5.2 Additional Clearance

CAUTION

If additional clearances are not met, damage to the property and water heater may occur.

Table 4

Location	Additional Clearance
Top	0 in. <i>Recommended clearance for optimal efficiency & servicing is 20 in. (508mm) on the top</i>
Back	0 in.
Left Side	6 in. (152 mm) <i>Recommended clearance for servicing is 12 in. (305 mm) on the sides</i>
Right Side	2 in. (51 mm) <i>Recommended clearance for servicing is 12 in. (305 mm) on the sides</i>

Figure 8

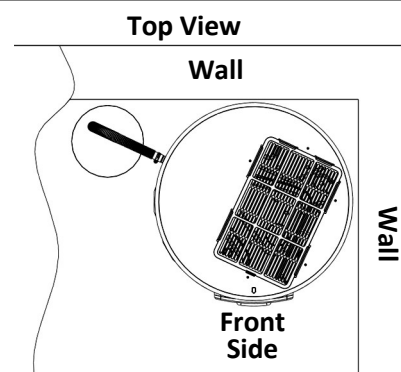

5.3 Recommended Locations for Maximum Energy Saving (Not Ducted)

NOTICE

If air temperature in installed location drops more than 15°F (8°C) during heating, air circulation is insufficient for efficient operation.

NOTICE

For installation in a room smaller than 700 ft³, fully louvered door or ducting should be installed for efficient operation.

Additional Ventilation Needed:

For room size: Smaller than 700 ft³ (i.e. 7' X 10' X 10'). Full louvered door required as shown in Figure 9.

Figure 9

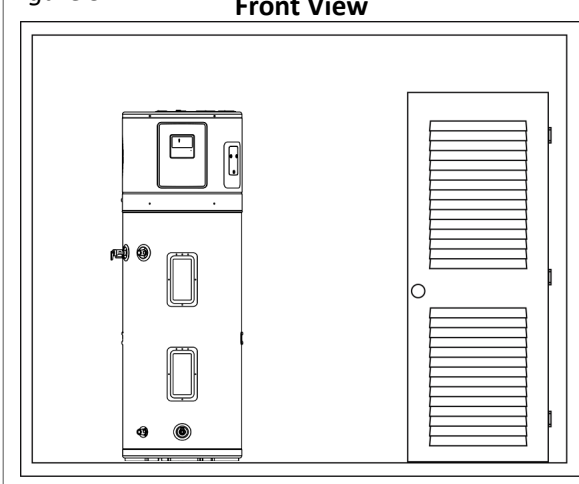

No Additional Ventilation Needed:

For room size: Larger than 700 ft³ (i.e. 7' X 10' X 10'). Illustrated in Figure 10.

Figure 10

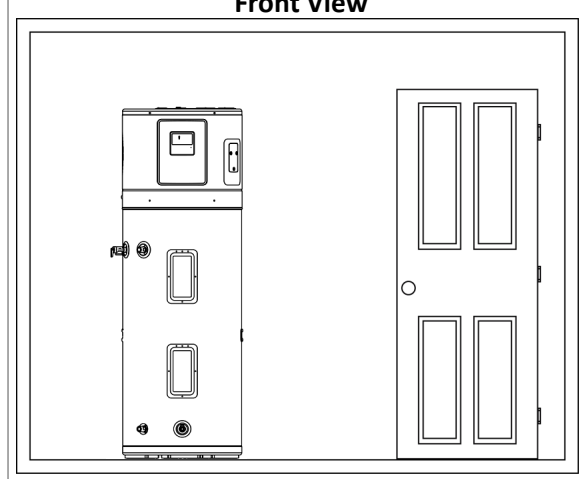

Laundry room or similar:

- 24 in² of air gap should be provided under the door for inlet air.
- Louver on the door must be located as the same height of air exhaust on the water heater.
- Water heater air exhaust must be positioned towards louver side within 12 inch from the door as shown in Figure 11.

Figure 11

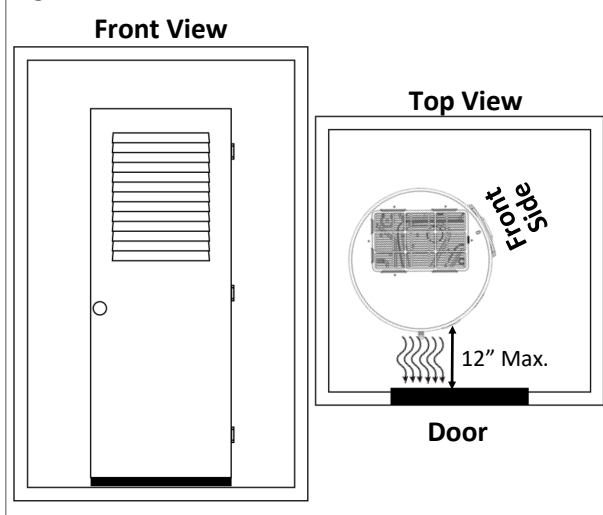

5.4 Inspect Shipment

Examine the water heater for damage and verify that the power supply matches the unit's requirements, as indicated on the rating plate (*Figure 12*) located on the front of the water heater.

Figure 12

MODEL NO. / N° DE MODÈLE	REHPS0
SERIAL NO. / N° DE SÉRIE	SA.YF-000001
IMFD./FAB	02Jan2024
VOLTAGE	208/240V- 60Hz, 1Ph
REFRIGERANT / RÉFRIGÉRANT	R134a / 18.3oz (0.52kg)
FAN MOTOR, RLA / MOTEUR DE VENTILATEUR, RLA	0.16 A / $\frac{1}{13}$ Hp
COMPRESSOR, RLA/LRA / COMPRESSEUR, RLA/LRA	1.92A/12.0A
DESIGN PRESSURE HIGH / PRESSION NOMINALE HAUTE	334 psig / 2300 kPa
DESIGN PRESSURE LOW / PRESSION NOMINALE BASSE	87 psig / 600 kPa
MAXIMUM FUSE OR HACR TYPE CIRCUIT BREAKER SIZE (MOP) / TYPE DE FUSIBLE MAXIMUM OU HACR TAILLE DU DISJONCTEUR (MOP)	25A(208V) / 30A(240V)
TANK VOLUME / VOLUME DU RÉSERVOIR	50 Gal / 189 Liters
LOWER/UPPER HEATING ELEMENT / ÉLÉMENT CHAUFFANT INFÉRIEUR/ SUPÉRIEUR	3380W(208V) / 4500W(240V)
TANK MAX.WORKING PRESSURE / RÉSERVOIR MAX. PRESSION DE SERVICE	150 PSI / 1034kPa
TOTAL CURRENT / COURANT TOTAL	21.5A
MOISTURE RESISTANCE, IP CODE / RÉSISTANCE À L'HUMIDITÉ, CODE IP	IP21



Hybrid Water Heater
Chauffe-Eau Hybride





Made in China
Fabriqué en Chine

Midea Part Number

5.5 Positioning the Heat Pump

- Arrive at site and conduct a safety audit. Safety audits can also be known as Work Method Statements (WMS) or Job Site Analysis (JSA).
- Park your vehicle as close as allowable to your installation. Unload all materials in a safe manner.
- Position all materials in a convenient position near the work area.
- This heat pump water heater **MUST** be installed indoors.
- Adequate access **MUST** be available to the T&P valve and an anode rod.
- Safely position the new unit on a level surface in accordance with all plumbing and building regulations.
- A suitable drain pan (*Figure 13*) **MUST** be used with EHPWH leak kit (sold separately) where property damage could occur from water spillage.

NOTICE

The auxiliary drain pan installation **MUST** conform to local codes. Drain Pan Kits are available from the store where the water heater was purchased, or any water heater distribution. The Drain Pan should not block the cold inlet or the drain valve. Ensure the floor beneath the water heater can support its filled weight adequately.

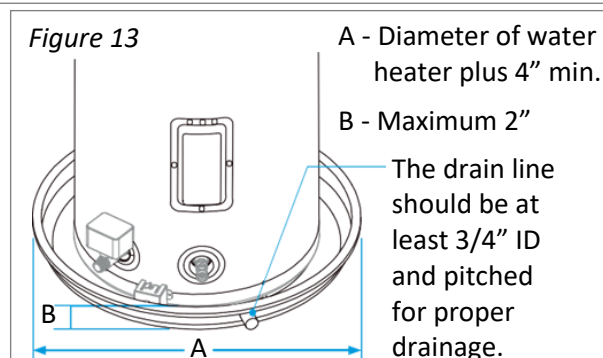

5.6 Thermal Expansion

Verify the presence of a check valve in the incoming water line by consulting your local water utility. It might be installed independently as a backflow preventer in the cold-water line or integrated into a pressure reducing valve, water meter, or water softener. A check valve in the cold-water inlet line can establish a "closed water system," while the absence of such a valve or backflow prevention device characterizes an "open" water system.

When water is heated, it undergoes thermal expansion, increasing pressure in the water system. In an "open" water system, excess expanded water returns to the city main, where pressure is easily dissipated. Conversely, a "closed water system" inhibits expanded water from flowing back into the main supply line, leading to a swift and hazardous pressure rise in the water heater and system piping. This rapid pressure increase may trigger the T&P valve at each heating cycle.

The continuous expansion and contraction due to thermal expansion can prematurely damage the T&P valve and potentially the heater itself. Simply replacing the T&P valve will not resolve the issue. To control thermal expansion, it is recommended to install a correctly sized expansion tank in the cold-water line between the water heater and the check valve. The expansion tank has an integrated air cushion that compresses with rising system pressure, alleviating overpressure conditions and preventing repeated relief valve activation. Alternative methods for managing thermal expansion exist; consult your installation contractor, water supplier, or plumbing inspector for more information on this matter.

5.7 Water Supply Connections

Please consult the illustration on *Figure 12* for a recommended standard installation. It is advisable to use flexible connectors for the hot and cold-water connections. These connectors offer vibration isolation and facilitate easy service of the water heater, if required.

The HOT and COLD water connections are distinctly labeled and measure 3/4" MNPT on all models. It is recommended to install a shut-off valve in the cold-water line near the water heater. Refer to Section 5.11, page 20 for instructions on how to fill the water heater.

CAUTION

This appliance must be permanently connected to the water mains. Hose-sets must not be used as water supply connections.

NOTICE

DO NOT apply heat to the HOT or COLD water connections. If sweat connections are employed, sweat the tubing to the adapter before fitting the adapter to the water connections on the heater. Any heat applied to the water supply fittings will result in permanent damage to the dip tube and/or heat traps.

NOTICE

- Operating temperature range of cold (inlet) water is 48°F (9°C) to 110°F (43°C).
- Operating pressure range is 43.5 psi (300 kPa) to 150 psi (1034 kPa).
- Water flow rate should be from 0.88 gpm (0.2 m³/h) to 3.08 gpm (0.7 m³/h).

5.8 Condensate Drain

Please check local codes or ordinances for precise specifications.

IMPORTANT: When making drain fitting connections to the drain tubing, use a clamp to secure.

IMPORTANT: Avoid overtightening when making drain fitting connections to the drain tubing, as it may lead to product damage and leaks.

- **Flexible drainage pipe with a clamp is provided with the unit.**
- **Drainage connection is built-in with the unit.**
- DO NOT reduce drain line size less than connection size provided on condensate drain.
- All drain lines must be pitched downward away from the unit a minimum of 1/8" per foot of line to ensure proper drainage.
- Drain lines must include a P-trap if connected to a sewer pipe.
- If no drain is available, then a common condensate pump with a capacity of no less than 2 gallon per day must be installed.
- DO NOT allow condensate to drain into the water heater drain pan.
- The drain line should be insulated where necessary to prevent sweating and damage due to condensate forming on the outside surface of the line.

NOTICE

The condensate produced by this unit is non-acidic and does not require a condensate neutralizer.

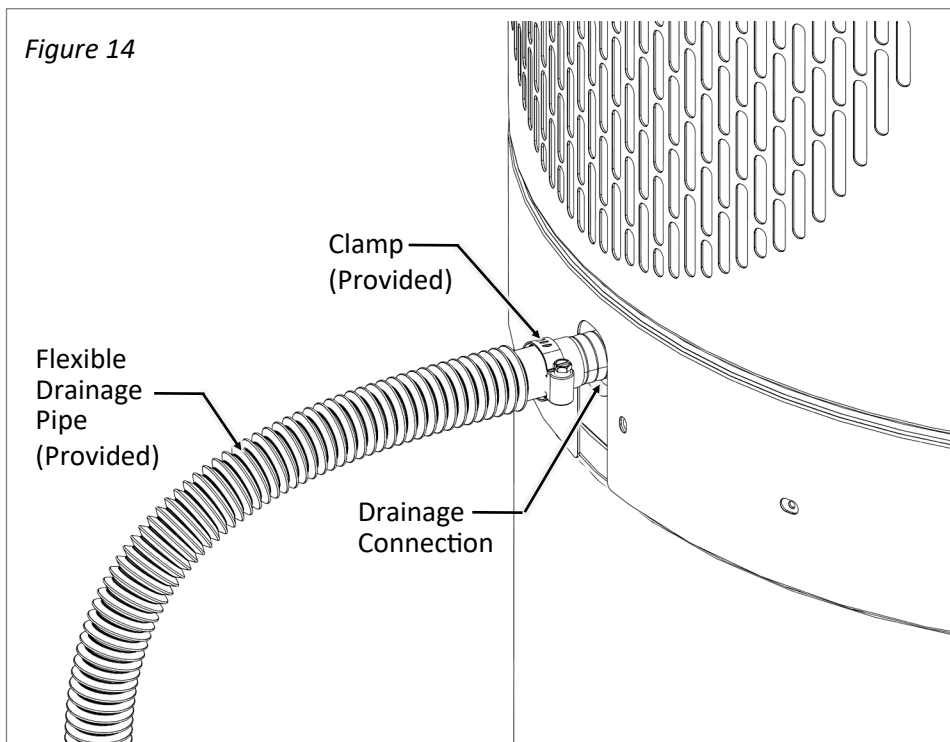

5.9 Typical Installation

Figure 15 illustrates the recommended typical installation of water heater.

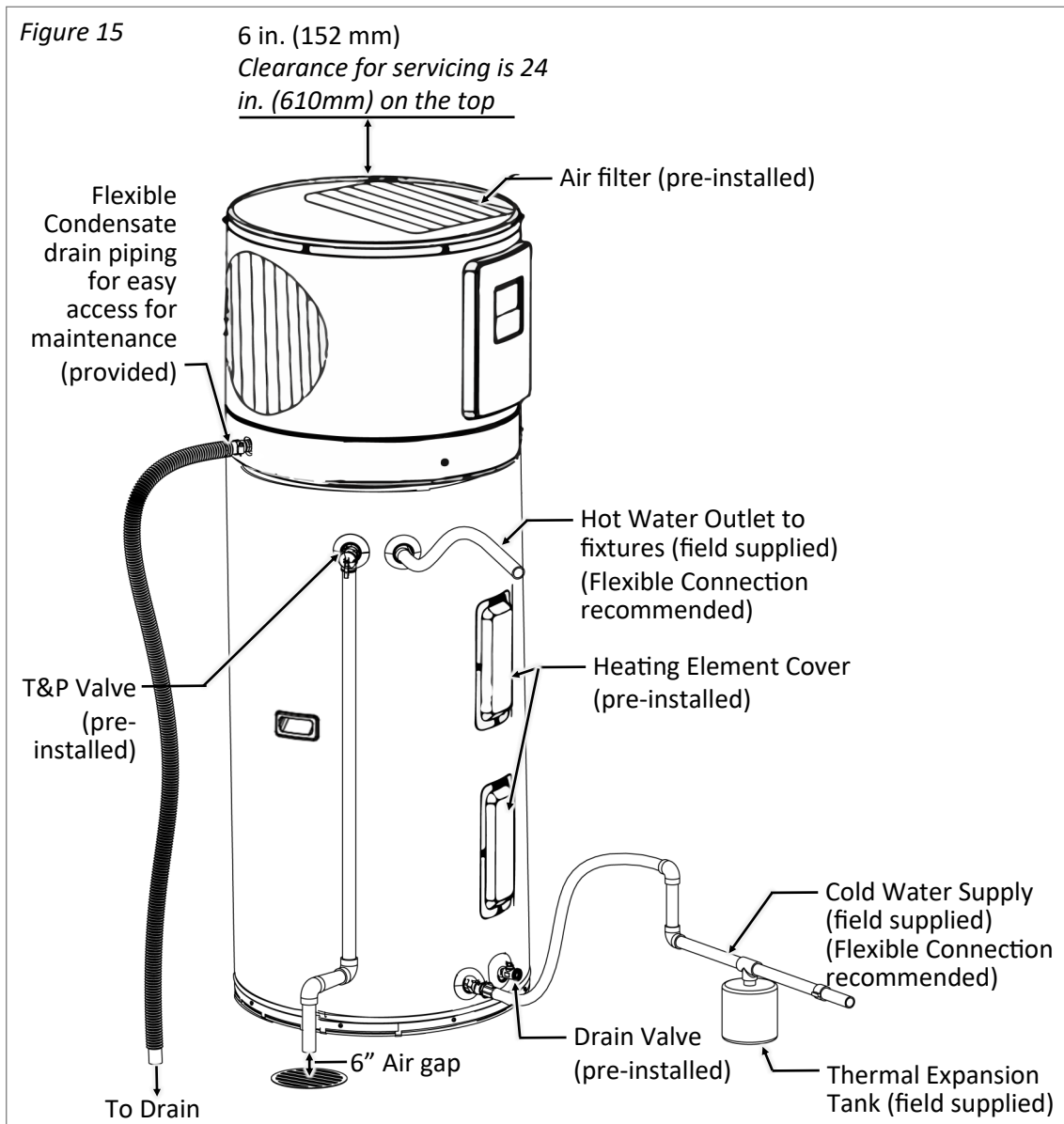

5.10 Relief Valve

- A newly installed temperature and pressure relief (T&P) valve, meeting the standards outlined in ANSI Z21.22/CSA 4.4 for Relief Valves in Hot Water Supply Systems, is factory-installed. It must remain in the designated opening, clearly marked for this purpose, on the water heater. No valves of any kind should be placed between the relief valve and the tank.
- The T&P discharge piping must be of a type approved for hot water distribution. The discharge pipe must be no smaller than the outlet of the T&P valve and must pitch downward from the valve to allow complete drainage (by gravity) of the relief valve and discharge pipe. The end of the discharge pipe should not be threaded or concealed and should be protected from freezing. No valve of any type, restriction or reducer coupling should be installed in the discharge piping.

 **WARNING**

The pressure rating of the relief valve must not exceed 150 PSI, the maximum working pressure of the water heater as marked on the rating place.

 **WARNING**

DO NOT link any other plumbing to the T&P plumbing; it must be directly connected to a suitable open drain. DO NOT join the T&P plumbing with the condensate plumbing.

5.11 To Fill the Water Heater

Ensure the drain valve on the water heater is fully closed. Proceed to open the shut-off valve in the cold-water supply line.

Gradually open each hot water faucet to enable the release of air from the water heater and piping.

If there is a continuous and steady flow of water from the hot water faucet(s), it indicates that the water heater is entirely filled.

 **WARNING**

Failure to adhere to the instructions outlined in this manual may result in permanent damage to the unit and could void the manufacturer's warranty.

 **WARNING**

DO NOT activate the electrical supply or operate this water heater unless it is entirely filled with water. The water heater must be filled with water before being turned on. Please note that the water heater warranty does not cover damage or failure resulting from operation with an empty or partially empty tank.

5.12 Electrical Connection

 **WARNING**

Prior to making any electrical connections, be sure to turn off the electric power at the fuse box or service panel. Additionally, ensure that the ground connection is established before proceeding with line voltage connections. Neglecting to follow these steps can lead to electrical shock, resulting in severe personal injury or death.

Before commencing maintenance, it is crucial to disconnect all power to the unit. Failure to do so can result in electrical shock, leading to severe personal injury or death. Additionally, ensure that the unit is grounded, as failure to do so can also cause electrical shock, resulting in severe personal injury or death.

DO NOT operate the water heater again if it has been exposed to fire, flood, or physical damage, until it has been inspected by a qualified service technician.

NOTICE

DO NOT use this appliance if any part has been submerged in water. Contact a qualified installer or service agency promptly to replace the water heater that has been exposed to flooding. DO NOT attempt to repair the unit! It must be replaced.

A qualified electrician must establish a separate branch circuit equipped with copper conductors, an overcurrent protective device, and appropriate disconnecting means. All wiring must adhere to local codes or the latest edition of the National Electrical Code ANSI/NFPA 70.

The water heater is fully connected to the junction box located inside the jacket at the top front of the unit. A knockout is provided on junction box cover for electrical fitting is available for field wiring connections. The voltage requirements and wattage load for the water heater are detailed on the rating plate situated on the front of the unit.

Grounding instruction:

1. Utilize metallic conduit or metallic sheathed cable approved for use as a grounding conductor, installed with fittings approved for this purpose.
2. If non-metallic sheathed cable, metallic conduit, or metallic sheathed cable not approved for use as a ground conductor is employed, it must incorporate a separate conductor for grounding. This grounding conductor should be connected to the ground terminals of both the water heater and the electrical distribution box.
3. The unit must be installed with a circuit breaker (including GFCI type) near the power supply and must be effectively earthed.
4. For wiring diagram, refer to Section 9.5, page 47.

Step to make Electrical Connection:

1. Locate the terminal block on top right side on water heater behind the junction box cover.
2. If CTA-2045 module is installed, remove the module to gain access of junction box cover.
3. Remove 3 screws to disassemble the junction box cover as shown in *Figure 16*.
4. Junction box comes with a 7/16" knockout to pass conduit cable through it.
5. As shown in *Figure 17*, connect Line 1 (L1), Line 2 (L2) and ground wire on the terminal block.
6. Mount back the junction box cover.

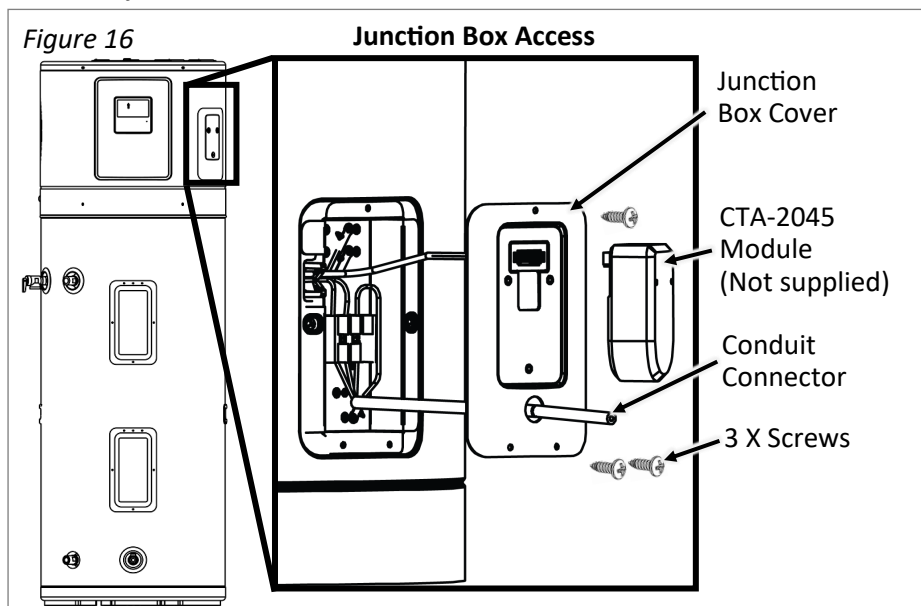
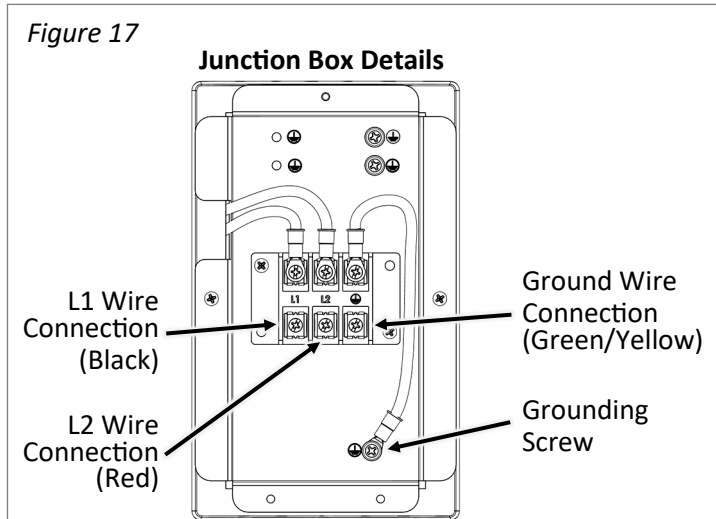

Figure 17



⚠ WARNING

DO NOT turn on the electrical supply or operate this water heater unless it is completely full of water.

⚠ CAUTION

The water heater and water pipes are not enough for effective grounding. Components like non-metallic piping, dielectric unions, and flexible connectors may electrically isolate the water heater.

⚠ NOTICE

This guide suggests the minimum branch circuit sizing and wire size in accordance with the National Electric Code. Please consult the wiring diagrams provided in this manual for details on field wiring connections.

Branch Circuit Sizing and Wire Size Guide - Single Phase Wiring

Table 5

Total Water Heater Wattage	Recommended Over Current Protection (Fuse or Circuit Breaker Amperage Rating)	Copper Wire Size AWG Based on NE.C Table 310-16 (75°C)
	240V	240V
2250	15	14
2750	15	14
3000	20	12
4000	25	10
5000	30	10
5500	30	10

NOTE: When sizing the breaker and wire for over current protection, include an additional 500W to the upper element wattage rating. This will account for the maximum amperage draw of the compressor and fan motor.

5.13 Insulation Blanket

⚠ WARNING

If local codes require external application of insulation blanket kits the, manufacturer's instructions included with the kit must be carefully followed.

Insulation blankets designed for external use on electric water heaters, which are readily available to the general public, are not deemed necessary. The primary function of an insulation blanket is to minimize standby heat loss commonly associated with storage tank heaters. In the case of this water heater, it either meets or exceeds the insulation and standby loss requirements outlined by the National Appliance Energy Conservation Act standards, rendering the use of an insulation blanket unnecessary.

It is important to note that the manufacturer's warranty does not cover any damage or defects resulting from the installation, attachment, or use of any energy-saving or other unapproved devices - excluding those explicitly authorized by the manufacturer - incorporated into, onto, or in conjunction with the water heater. The utilization of unauthorized energy-saving devices may compromise the lifespan of the water heater and pose risks to life and property. The manufacturer explicitly disclaims any responsibility for losses or injuries resulting from the use of such unauthorized devices.

If local codes mandate the use of an external insulation blanket for this water heater, it is essential to meticulously observe the following guidelines to avoid impeding the proper function and operation of the water heater.

⚠ CAUTION

- DO NOT obstruct or cover the operating or warning labels affixed to the water heater.
- DO NOT attempt to reposition any labels on the exterior of the insulation blanket.
- DO NOT block the air openings on top and left side of the water heater.
- DO NOT conceal the Controller Assembly, T&P valve, or drain valve.
- Frequently inspect the insulation blanket.

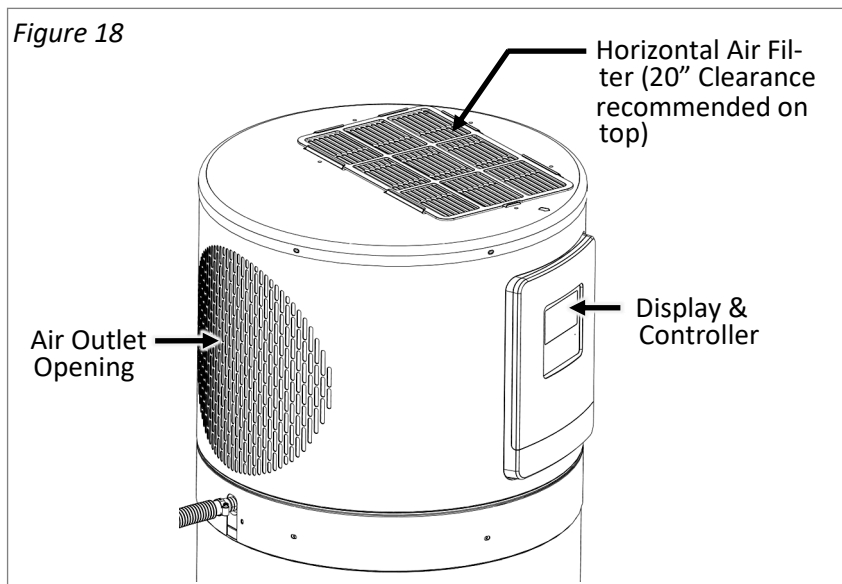

5.14 Hot and Cold Pipe Insulation Installation

Install pipe insulation on the cold water supply inlet and the hot water outlet as shown in *Figure 19*.

Figure 19

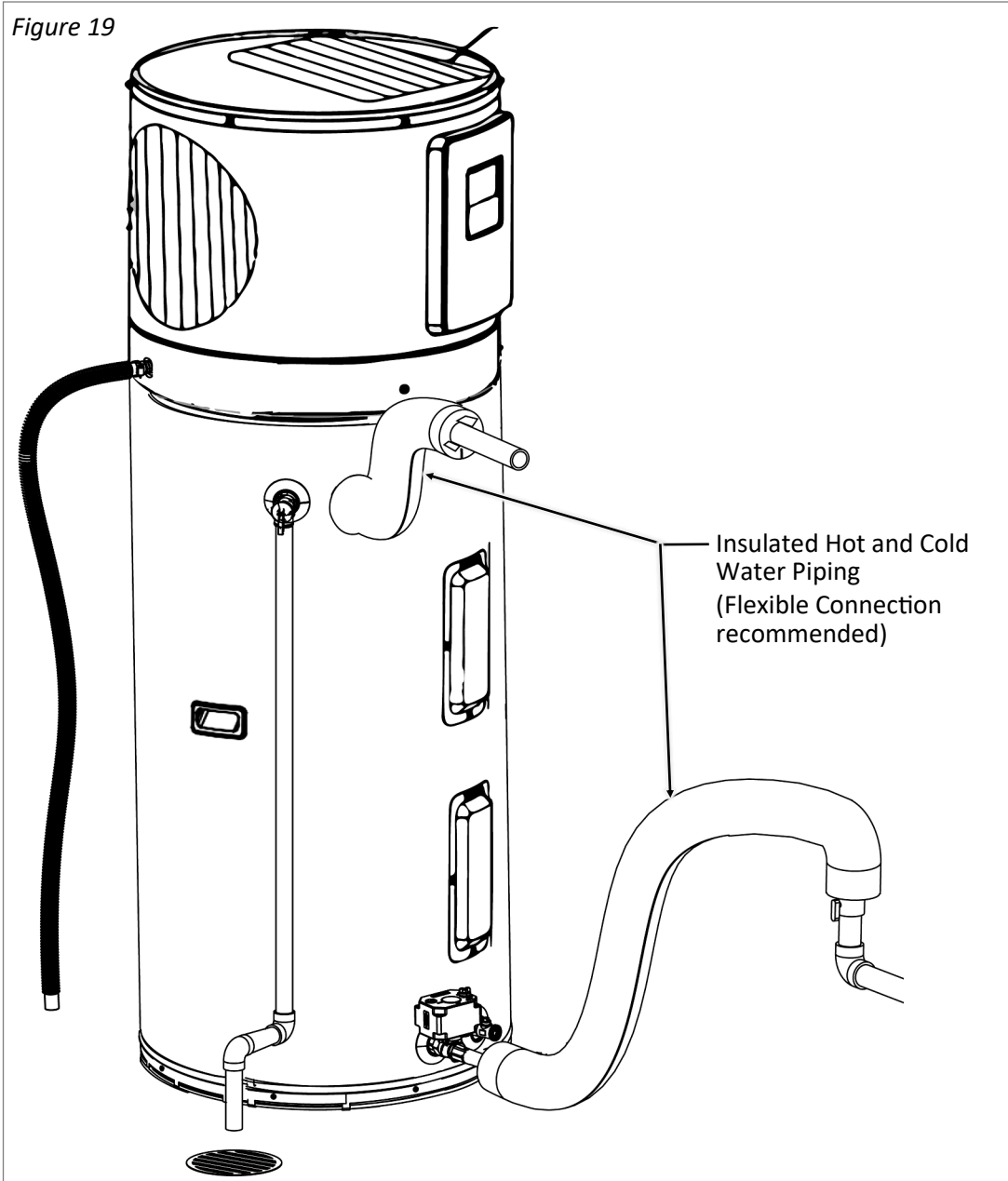

5.15 Ducting Requirement

Please refer a separate instructions provided with EHPWH Ducting Kit - 103000120 (Accessory) for all ducting requirements.

NOTICE

DO NOT skip the ducting requirement document if any kind of ducting is installed. Ducting installation must follow all ducting requirements as mentioned in the separate instructions.

6. Operating Instruction

6.1 Start-Up Information

CAUTION

Hydrogen gas has the potential to accumulate in a hot water system when the water heater has remained unused for an extended period, typically two weeks or more. It's crucial to be aware that HYDROGEN GAS IS EXTREMELY FLAMMABLE!

To mitigate the risk of injury and disperse any accumulated gas, it is strongly recommended to open the hot water faucet at the kitchen sink for several minutes before using any electrical appliances connected to the hot water system. If hydrogen is present, you may hear an unusual sound resembling air escaping through the pipes as the water begins to flow. It is imperative that during this process, NO smoking or open flames are allowed near the open faucet. Exercise caution and prioritize safety.

Safety Precautions

- If the water heater has been exposed to overheating, fire, flood, or physical damage, ensure all power is disconnected.
- DO NOT attempt to turn on the water heater unless it is properly filled with water.
- DO NOT activate the water heater if the shut-off valve for the cold water supply is closed.
- In case of challenges comprehending or adhering to the Operating Instructions or the Care and Cleaning section, it is advisable to seek the assistance of a qualified individual or service technician.

WARNING

If the water heater has been subjected to fire, flood or physical damage, disconnect all power to water heater, and DO NOT operate the water heater again until it has been checked by a qualified service technician.

NOTICE

DO NOT use this appliance if any part has been submerged in water. Contact a qualified installer or service agency promptly to replace the water heater that has been exposed to flooding. DO NOT attempt to repair the unit! It must be replaced.

Safety Controls

The water heater features a thermal cut-off (TCO) positioned near the upper heating element, making contact with the tank surface. If the water temperature becomes too high, the TCO interrupts the power supply to the heating element. After activation, it requires manual resetting. Refer Section 9.4, page 46 for resetting instructions.

CAUTION

A qualified service technician must investigate the cause of high-temperature and take corrective actions before putting the water heater back into operation.

DANGER

Setting the thermostat too high can create a scalding risk. Homes with young children, the elderly, or individuals with disabilities may need to set the thermostat to 120°F (49°C) or lower to avoid exposure to hot water.

Water Temperature Setting

Regulate your water heater's temperature through the control display, keeping safety and energy savings in mind. Lower settings reduce energy costs. For safety, the factory default is 120°F (49°C), which is the recommended starting point. Temperatures above 125°F (52°C) can cause severe burns. Always follow the manual and label warnings on the front of the heater.

Consider installing mixing valves to blend hot and cold water for safer point-of-use temperatures, following ASSE 1017 standards. For demand response, use ASSE 1017-compliant thermostatic mixing valves on the hot water supply line, per manufacturer instructions. Refer *Table 1*, page 5 to determine the right water temperature for your home.

6.2 Operation

6.2.1 Overview

NOTICE

The heat pump's fan will not turn on if the incoming water temperature is less than 39°F (4°C) and/or the ambient air temperature is above 107.6°F (42°C), or below 37.4°F (3°C). The internal diagnostics detects that the heat pump is out of operational range.

- The primary function of the control panel is to allow user to set temperature. Additionally, it provides access to extra features like setting up schedule, check performance data, show error codes, update engineering channels etc.
- The water heater has three means of heating the water: the elements, the heat pump, and a combination of the elements and heat pump.
- The control logic of the Control Assembly is designed so that the heat pump always has priority over the elements. The temperature regulation will not be performed until after Dry-Fire detection testing indicates that there is sufficient water in the tank.
- Refer *table 6 and 7* to understand display icons and available operations on this appliance.

6.2.2 Control Panel Location

As shown in *Figure 20*, control panel is located on top side on water heater.

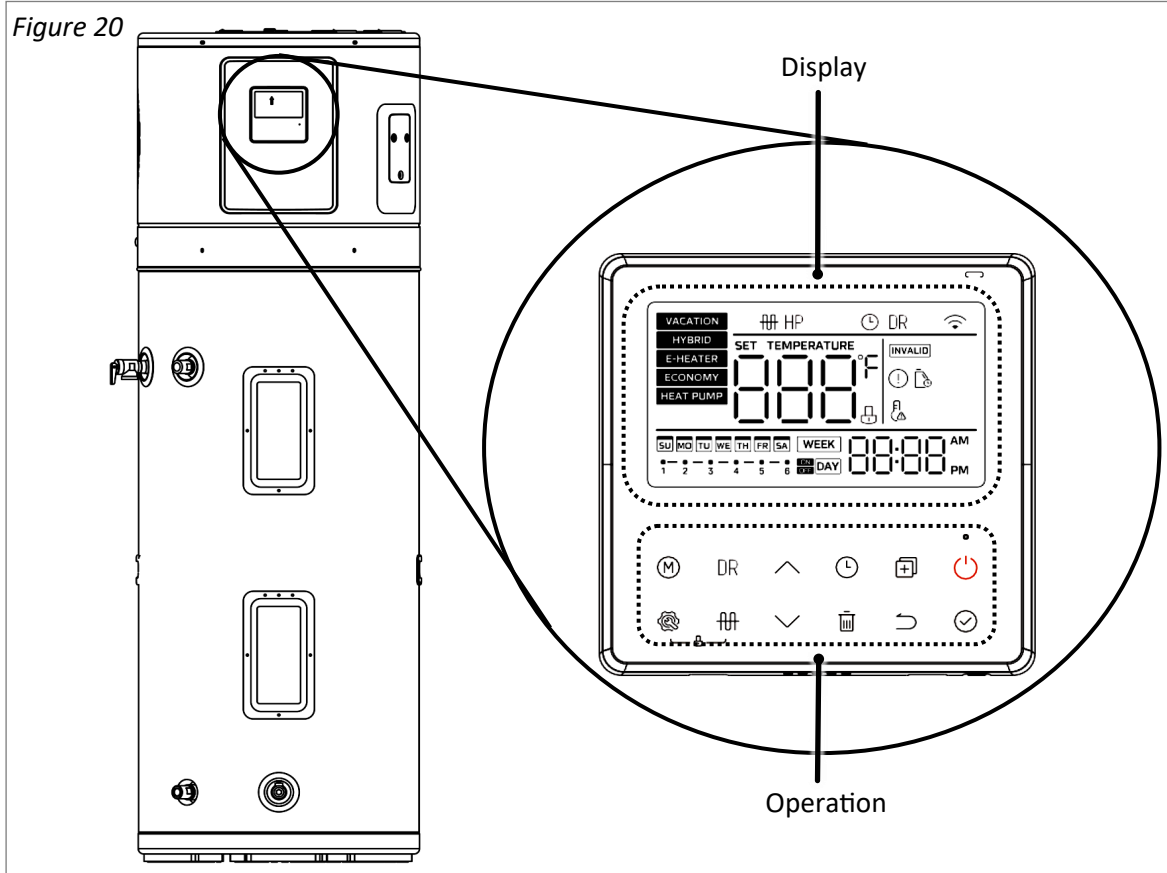

6.2.3 Display Icon Explanation

Figure 21 shows all the available icons on the display. Refer *Table 6* for detailed explanation of each icon.

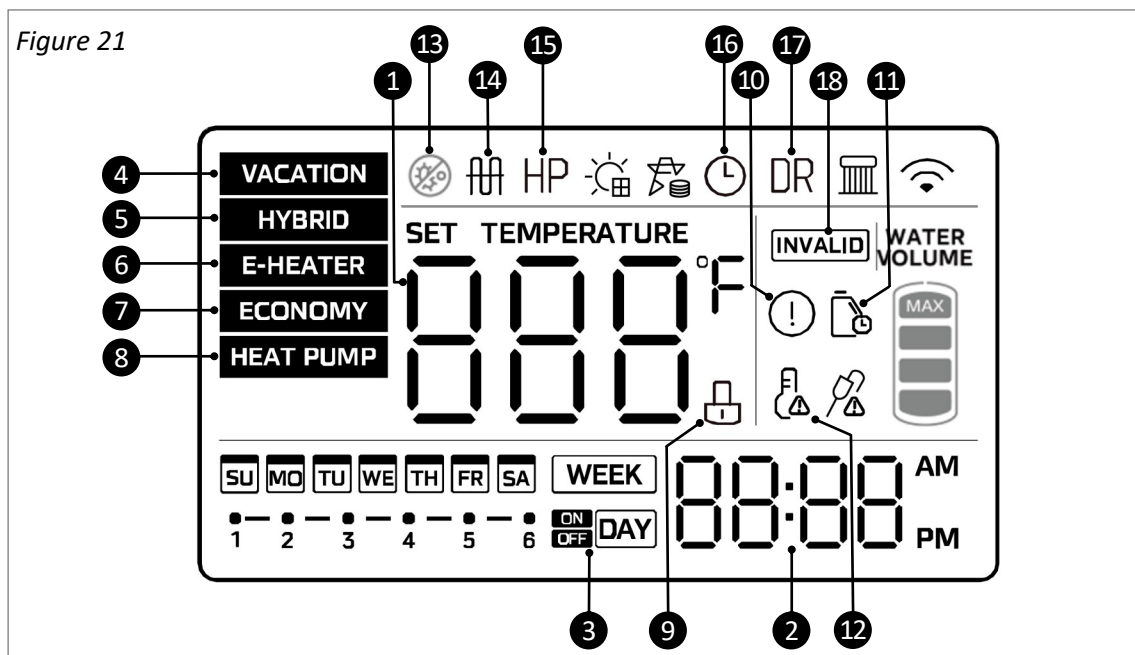

Table 6

No	Icon	Description
1		<ul style="list-style-type: none"> Normally, it shows tank water temperature. When “^” or “v” arrows pressed, it shows set temperature . (“ SET TEMPERATURE ” on top side lights up) On VACATION mode, it shows remaining days of vacation modes. It shows setting temperature on setting. It shows unit setting/running parameters or error/protection code on performance data.
2		<p>Time and clock setting</p> <ul style="list-style-type: none"> 10:30^{AM} shows the clock. Whenever there is any setting for clock, SET TIME will be lightened.
3		<ul style="list-style-type: none"> There are daily or weekly TIMER icon. If anyone of them has been set, either “ WEEK ” or “ DAY ” shows up. It remains empty if none of the timer is set. While setting up a timer, the corresponding icon flashes every 2 seconds to indicate it has been selected.
4		<p>VACATION MODE: When set to VACATION mode, the water tank is set at 59°F (15°C), maintains low tank water temperature, preheats hot water and anti-freeze lines, while reducing on/off operation of the tank.</p>
5		<p>HYBRID MODE: Operating in HYBRID mode, the electric heater and heat pump run together to fulfill hot water demand.</p>
6		<p>E-HEATER MODE: When set to E-HEATER mode, only electric heater runs and provides hot water.</p>
7		<p>ECONOMY MODE: (Default) When set to ECONOMY mode, the heat pump and electric heater run together with higher priority to heat pump to fulfill hot water demand. Electric heater turns on only when the hot water demand gets extremely high. It is recommended to use this mode to maximize electricity cost savings.</p>
8		<p>HEAT PUMP MODE: When set to HEAT PUMP mode, only heat pump will run to provide hot water.</p>
9		Indicates when child lock function is enable. Locks all operational buttons.
10		<p>Protection/Error: It lights up when the appliance is under protection/error.</p>
11		<p>Maintenance Reminder: It flashes to remind the user to maintain the water tank.</p>
12		<p>High temp. Alert: If water temp is higher than 122°F (50°C), it lights up.</p>
13		<p>Self Cleaning Alert: It lights up when the tank is self-cleaning.</p>

14		Electric Heater Icon: It lights up when element heater is running. NOTE: When the operating conditions are not met to turn on this function, the corresponding icon on the wire controller lights up briefly and then goes out.
15	HP	Heat Pump Icon: When the heat pump is operating and producing hot water, the icon lights up.
16		Clock Icon: The icon lights up when the clock is being set.
17	DR	DR Icon: <ul style="list-style-type: none"> When the DR function is enabled, the icon remains on. After the DR function is enabled, if a general power limit request, basic load request, advanced load request, or emergency power limit request is received, the icon DR will flash slowly; When receiving an emergency power outage request, the icon flashes quickly.
18	INVALID	It flashes 3 times when any input is invalid.

6.2.4 Operation Explanation



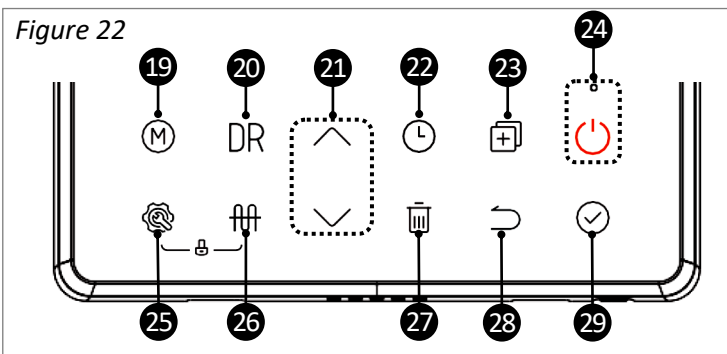

















Figure 22 shows all the available buttons on the controller. Refer Table 7 for detailed explanation of each button. All buttons are touch sensitive. It is recommended not to hard press buttons to maintain the long lifespan of controller.











Any pressing of button is effective only under button and display in unlocked state. (refer child lock function to unlock button/display as shown in Table 8)

Table 7



No	Icon	Description
19		<p>Change Mode of Operation</p> <ul style="list-style-type: none"> Default ECONOMY mode Switch to HEAT PUMP mode Switch to VACATION mode Adjust vacation days (1-360 days) Switch to HYBRID mode Switch to E-HEATER mode Switch to ECONOMY mode <p>*If the mode is changed to E-heater, within 72 hours, it will automatically change back to ECONOMY mode (when 72 hours is the power on time)</p>

20	DR	<p>Demand Response</p>  <p>When the DR icon goes out, the DR function is not turned on. Click this button to turn on the DR function.</p> <p>After the DR function is enabled, if a general power limit request, basic load request, advanced load request, or emergency power limit request is received, the icon will flash slowly, when receiving an emergency power outage request, the icon flashes quickly.</p> <p>If you need to turn off the DR function, you need to click the DR button again while the DR is on and the device is on, and the DR icon will turn off.</p>
21	 	<p>INCREASE AND DECREASE (UP/DOWN)</p> <p>If screen is unlocked, corresponding value increases by pressing the button.</p> <ul style="list-style-type: none"> • When adjusting set temperature, press more than 1s, temperature value increases continuously. • When setting clock/timer, press more than 1s, clock/timer value increases continuously. • When setting vacation days, press more than 1s, day value increases continuously.
22		<p>DAILY SCHEDULE</p> <ol style="list-style-type: none"> 1) Press the TIMER button  until the day timer icon  turns on, press the confirmation button  to enter the day timer setting, the day timer has a total of 6 time periods, each time period can be set to timer on, timer off, mode, set the temperature of the water; to the first timer period, set the temperature of the water, press the confirmation button  to enter the next time period of the set; when set the sixth time period set the temperature of the water, press the confirmation button  to return to the main interface; during this period, you can press the return button  Return to the previous setting 2) When setting the on time and off time, press the delete button , the time can be restored to the default value, and displaying (-.-). 3) If there is a conflict between the set time periods, the previous time period stays valid, and the entered time period becomes invalid time period; the invalid time period restores the default setting. <p>WEEKLY SCHEDULE</p> <ol style="list-style-type: none"> 1) Press the TIMER button  until the weekly timer icon  turns on, press the confirmation button  to enter the weekly timer setting interface, weekly timer is a total of 7 days, there are 6 time slots can be set each day, each time slot can be set to timer on, timer off, the mode, set the water temperature; when the first time slot set the water temperature, press the confirmation button  to enter the next time slot settings; when the sixth time slot set the temperature, press the confirmation button  to return to weekly. After setting the water temperature for the 6th period, press the confirmation key  to return to the selection of week; during this period, you can press the return key  to return to the previous level of setting or the main interface; 2) When setting the on time and off time, press the delete button  to restore the time, mode and set water temperature to default value, and displaying (-.-). 3) If you adjust the timing after the setting is completed, then all the settings after the adjustment time period gets canceled. For example, if you adjust the timer on for time period 2, the timer off for time period 2, and the settings for time periods 3, 4, 5, and 6 get canceled to (---) after adjustment. Mode and setting water temperature become default values (ECONOMY, 120°F (49°C)) 4) In the weekly timer setting, use the copy button , you can locate the setting of a certain day to the base day, select other days, press the copy button, the fast flashing indicates “selected” and the slow indicates “not selected”, after pressing on the confirmation button , you can copy the setting of the base day to the selected day; <p>*You can enter the timer setting in both power-on and power-off state.</p>

23		<p>COPY</p> <p>It is used to copy selection and paste in combination with other buttons to complete the function.</p>		
24	<p>•</p> 	<p>Power on/off button</p> <p>Press the button to turn the device on or off. Small red led indicated if the device is on/off.</p>		
25		<p>Performance Data</p> <ol style="list-style-type: none"> 1) In the main interface, press “26		<p>E-Heater</p> <p>Press the button to turn the e-heater on instantaneously.</p>
27		<p>Delete</p> <p>It is used to restore timer to default values and can be used to delete other selected data.</p>		
28		<p>Return</p> <p>It is used to return to previous setting/screen.</p>		
29		<p>CONFIRM/UNLOCK</p> <p>If screen and buttons are unlocked, press it to upload setting parameters after adjusting any parameter.</p>		

6.2.5 Combination Button

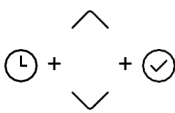
Table 8

No	Icon	Description
Setting the Date and Clock		<ol style="list-style-type: none"> 1) In the main interface, press and hold the timer button for 3 seconds to enter the date setting, press the up/down button to select the date, press the confirmation button to enter the clock setting, press the up/down button to modify the time, and press and hold to accelerate the increase/decrease of the time. After setting the clock, press the confirm button to return to the main interface to complete the setting of date and time. 2) After 30 seconds from the last operation of the up/down button or pressing the return button or the power on/off button, you can directly exit the date and time setting; 3) Setting can be done in both power-on and power-off state. <p>NOTE: Ensure to set date and clock before setting up schedule to prevent inaccurate scheduling.</p>
Child lock function		<ol style="list-style-type: none"> 1) In the main interface, long press the key combination for 2 seconds to enter the child lock state; 2) In the state of child lock, long press the key combination again for 2 seconds to release the child lock state; 3) In the locked state, there will be an icon  next to the water temperature display.

6.2.6 Change Mode of Operation

Press the “(M)” button to change operating mode on the unit (refer *Figure 22*).

Operation Modes:

- ECONOMY (Default)
- HEAT-PUMP
- VACATION
- HYBRID
- E-HEATER

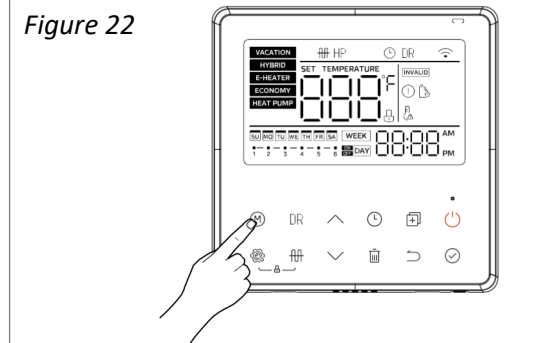



Table 9

Mode	Efficiency	Recovery
Vacation	N/A	N/A
Hybrid	Low	High
E-Heater	Very Low	Very High
Economy (Default)	High	Low
Heat-Pump	Very High	Very Low

6.3 Engineering Channel

To enter the engineering channel mode:

Press and hold the “” button for 3 seconds on the main interface.



Select engineering channel, press the “” button to enter, and switch between valid values using the “” and “” buttons (Refer *Figure 23*).

Figure 23

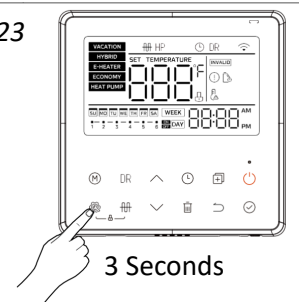



Table 10

Engineering Channel 1	Unit Temperature	0: °F (Default) 1: °C
Engineering Channel 2	Maintenance Reminder	0: off 1: on (Default)
Engineering Channel 3	Maintenance Time Setting	Default value: 365 days (It can be set between 30 ~365 days)
Engineering Channel 4	Maintenance Time Reset	0: Do not clear (Default) 1: Clean up (Resets the maintenance time to preset days) (clears the  icon from display)
Engineering Channel 5	Clear Error Code	0: Default 1: Clear Error Code (Mainly used to clear error code PHDH) NOTE: DO NOT clear error without taking preventive actions first.
Engineering Channel 6	Electric Heater Switch	0: Off (Permanently turns off electric heater) 1: On (Default)
Engineering Channel 7	Automatic Self Cleaning Switch	0: Off (Default) (Permanently turns off automatic self cleaning function) 1: On
Engineering Channel 9	Set Self Cleaning Hours	Default value: 10 hours (It can be set between 0~23 hours)
Engineering Channel 11	Set Vacation Temperature	Default value: 15°C (It can be set between 15~20° C)
Engineering Channel 14	N/A	Default value:  NOTICE: DO NOT change the default setting.
Engineering Channel 15	Dry Fire Protection Switch	0: Invalid (Permanently turns off dry fire protection function) 1: Valid (default) NOTICE: DO NOT change the default setting unless used for troubleshooting.
Engineering Channel 16	Current Detection Switch	0: Invalid (Permanently turns off current detection function) 1: Valid (default) NOTICE: DO NOT change the default setting unless used for troubleshooting.

Engineering Channel 17	Set Self Cleaning Temperature	Default value: 65°C (It can be set between 65 ~ 70°C)
Engineering Channel 18	Higher Set Temperature	Default value: 65°C (It can be set between 65 ~ 70°C)
Engineering Channel 21	Set 485 Communication Address	Default value: 1 (It can be set between 1 ~ 20)
Engineering Channel 23	Reset All Channels	0 : off (Default) 1 : on (Valid only once) (resets all engineering channels to default)
Engineering Channel 26	Set Self Cleaning Minutes	Default value: 0 minutes (It can be set between 0~59 minutes)
Engineering Channel 27	N/A	Default value: 1 NOTICE: DO NOT change the default setting.
Engineering Channel 30	Backlight	0 : off (Backlight stays always on) 1 : on (Backlight turn on only when button pressed) (Default)
Engineering Channel 34	Alarm Sound Disable	0 : off (Default) (beeps when audible error code occurs) 1 : on (turns off audible sound of error code) NOTICE: ALWAYS set channel back to default after taking corrective actions.
Engineering Channel 35	Automatic Child Lock	0 : off (Default) 1 : on (Locks button after 1 minute of no use)
Engineering Channel 38	Shut-Off Valve Setting	0 : off (Default) 1 : on NOTICE: Must set to "ON" when leak kit (103000119) is installed.
Engineering Channel 39	Self Cleaning	0 : off (Default) 1 : on (Valid only once) (heats up tank water to 150°F (65°C))
Engineering Channel 40	Duct Setting	0 : off (No Duct installed) (default) 1 : on (Duct installed) NOTICE: Must set to "ON" when duct kit (103000120) is installed.

7. Care & Cleaning

7.1 Routine Preventive Care

DANGER

To avoid scalding risks, ensure that no one is exposed to hot water when manually operating the relief valve. Release the water into an appropriate drain to avoid injuries or property damage.

NOTICE

Thermal expansion in a closed loop water system can cause the temperature and pressure relief valve on the water heater to discharge periodically.

Consult your water heater supplier or a qualified plumber to correct it. DO NOT block the relief valve outlet.

Regular maintenance ensures your water heater's long, trouble-free operation. This appliance has a maintenance reminder. Default is 365 days. When the maintenance time is due, display shows  icon. Establish and follow a maintenance routine. Refer *table 10* to reset maintenance timer once completing all check-ups/clean ups.

Note that most electrical appliances, including new ones, produce some operational noise. If you notice an excessive increase in noise levels, contact a qualified installer or plumbing contractor for inspection.

When water-using appliances with solenoid valves close rapidly, it may cause a hammering effect / noise in the water pipes. To minimize this issue, you can use strategically placed risers in the water pipe system or employ water hammer arresting devices.

IMPORTANT: Lift and release the lever handle on the T&P valve, located on the side of the water heater, at least once a year to confirm its

7.2 Draining the Water Heater

Figure 24

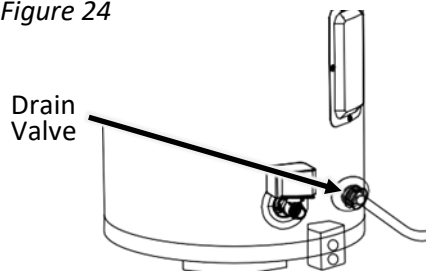

CAUTION

Turn off the water heater's power before beginning to drain water.

DANGER

Ensure safety by confirming that nobody is in the vicinity of the hot water discharge when using the drain valve. The water from the tank could cause scalding, so direct it to a proper drain to prevent harm or damage.

Sediments suspended in water can accumulate at the bottom of a water heater's tank, often due to hard water. To prevent this buildup, it's recommended to drain a few quarts of water from the tank every month.

To drain the water heater, first shut-off the cold-water supply. Then, either open a hot water faucet or lift the relief valve easing gear to let air into the tank. You must first attach the garden hose. Then close cold supply, and open hot faucet/T&P valve, then open drain valve.

7.3 Element Heater

Check if the resistance across element heater is $15 \text{ Ohms} \pm 10 \text{ Ohms}$. If resistance is out of range, replace the element heater. Refer *table 14* to order element heater replacement part.

7.4 Air Filter Maintenance

It's recommended to clean the air filter located on the top of the water heater every 3 months. Clean it with mild detergent and water, then dry and install it back. To remove the filter, lift and slide it to the front of the unit, and to replace it, lower it into the filter slot on top

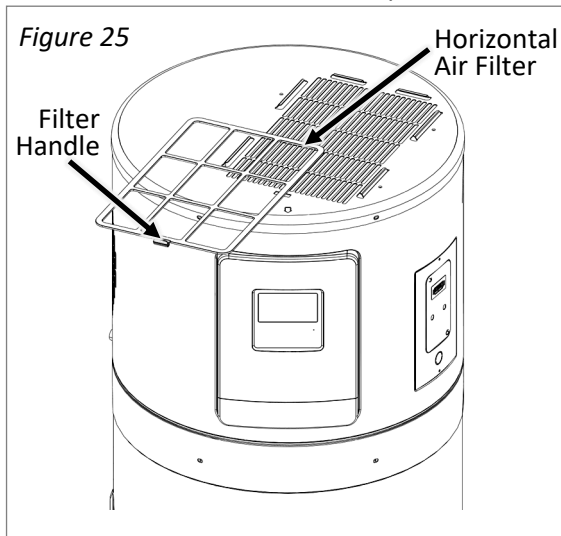

7.5 Condensate Drain Maintenance

Ensure unobstructed condensate flow, clear blockages if necessary. Pour a cup of bleach into the condensate drain access opening at least once a year to eliminate any algae, mold, or mildew that may have developed in the pipe.

7.6 TCO Switch Check

Perform a continuity test between all 4 mounting screws around TCO switch to ensure TCO switch works fine. If it fails continuity test, replace the TCO switch. Refer *table 14* to order TCO replacement part.

7.7 Vacation and Extended Shut-Down

⚠ NOTICE

Refer to the Hydrogen Gas Caution in the Operating Instructions.

Change the mode of operation to “VACATION” if water heater not in use for a long time, to save energy and avoid hydrogen gas build-up.

In case of unit shut down, drain the water heater and pipes to prevent damage from freezing. Have a professional inspect the heater after a long shutdown and ensure its fully refilled before use.

7.8 Anode Rod Maintenance

⚠ NOTICE

Avoid removing the anode rod from the water heater as it shortens the tank's lifespan and voids the warranty. The anode rod is designed to reduce corrosion in the glass-lined tank and is slowly consumed. High sulfate/mineral content in water can cause a rotten egg smell and chlorination of the water supply can reduce this.

This water heater is equipped with an anode rod engineered to extend the longevity of the glass-lined tank. The anode rod undergoes gradual consumption, effectively preventing or reducing corrosion of the glass-lined tank.

It is recommended to replace anode rod every 5 years (IMPORTANT: life of the anode rod depends on the water usage and quality. It may need to be replaced earlier than recommended time).

8. Troubleshooting Tips

8.1 Before you Call for Service



Save time and money! Review the chart on this page first and you may not need to call for service.

8.2 Troubleshooting

8.2.1 Non-Error Tips

Q: Why can't compressor start immediately after setting?

A: The unit will wait for 3 min to balance the pressure of system before starting the compressor again, it's a self-protection logic of unit.

Q: Why does the temperature shown on the display panel decreased while unit is running?

A: When the upper tank temperature is much higher than the lower tank temperature, the upper hot water will be mixed by the lower cold water which continually flows from inlet. This will decrease the upper temperature.

Q: Why does the element heater never turns on even if tank temperature is significantly lower than set temperature?

A: Scenario 1: The unit is able to fulfill hot water demand without utilizing the backup element heater.

Scenario 2: If unit is turned on for the first time, it goes through initial set up and runs the dry-fire protection logic to ensure that the tank is filled with water.

Scenario 3: Check if electric heating switch parameter is set correctly. Engineering channel 6 should be set to "1".

Q: Why does the temperature display show low temperature when hot water is still available?

A: the upper temperature sensor is located 1/4 from the top of the tank. It is possible for the top 1/4 to still be hot.

Q: Why are the buttons unavailable sometimes?

A. The unit features child lock function to avoid any accidental touch. It is indicated by "🔒" icon on the display. To unlock, press "🌀" and "🔑" simultaneously for 2 seconds.

8.2.2 When Error happened

1. If an error occurs and unit starts again after self diagnostics/restart, please contact qualified and trained professional for maintenance.
2. If an error occurs and unit does not start, please cut off the power supply and contact qualified and trained professional for service. DO NOT attempt to resolve the error in the absence of qualified professional.
3. If a fault occurs, the "ⓘ" icon will light up, the buzzer will beep at intervals, and the main interface will display a fault code.
4. Refer Section 8.4 (Table 13) for more details.

8.3 Performance Data



Press the “” button (for <3 sec) to see the performance data. Use “” or “” buttons to scroll through each performance data. Refer Table 12 for data description and unit.

Figure 26

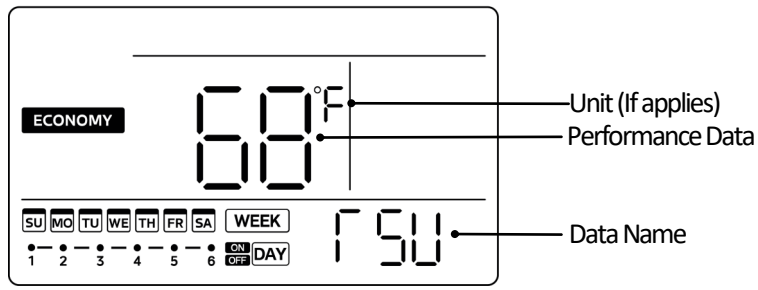
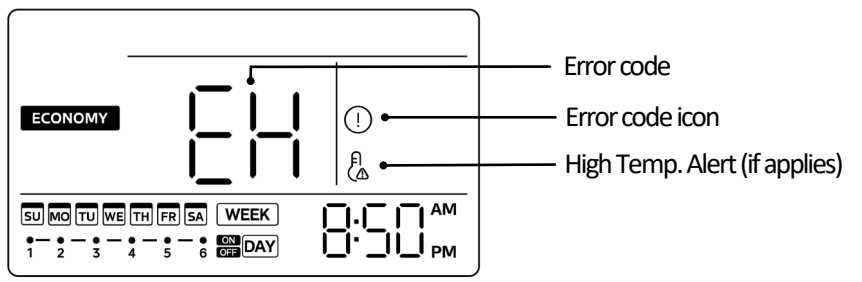

Table 12

Data Name	Performance Data Description	Unit
T5U	Upper water temperature sensor (T5U)	°F/°C
T5L	Lower water temperature sensor (T5L)	°F/°C
T5I	N/A (Default: ---)	-
T5	Heat pump operating temperature max.	°F/°C
T3	Evaporator temperature sensor (T3)	°F/°C
T4	Ambient temperature sensor (T4)	°F/°C
TP	Compressor discharge temperature sensor (TP)	°F/°C
TH	Compressor suction temperature sensor (TH)	°F/°C
On	N/A (Default: ---)	-
FFr	N/A (Default: ---)	-
FF	Set temperature for self cleaning	°F/°C
Co	Compressor and electric heating current	Amps
F0	DC fan Speed	(rpm/10)
Eo	Machine Parameters (0~255)	-
EEr	Electronic expansion valve opening	Angle (Degree)
EEC	Compression mechanism hot water demand	-
PUP	N/A (Default: ---)	-
PS	N/A (Default: ---)	-
FF	Fan Type (0: AC fan or 1: DC fan)	-
HF	Electric heater controller type	-
HP	Compressor controller type	-
F5I	N/A (Default: ---)	-
S1o	Tank capacity	Liters
P4P	N/A (Default: ---)	-
UU	N/A (Default: 0)	-
U1	Main PCB software version	-
U2	Display controller software version	-
U3	N/A (Default: 000)	-
U4	No of Electric heaters (0: one e-heater or 1: two e-heaters)	-
U7	N/A (Default: 2)	-
1Er	Last error code	Error Code
2Er	2 nd last error code	Error Code
3Er	3 rd last error code	Error Code
HHH	Maintenance time	days
TLF	Set (target) Temperature	°F/°C
End	End of the performance list	-

8.4 Error Codes

Figure 27



- Refer the following table to understand the occurring error code and take corrective actions accordingly. If there is any active error code, error code icon lights up and unit beeps until the error code is resolved or turned off manually.
- All alarms are audible (makes beeping noise) and they can be turned off by changing the engineering channel 34 to “1”.

NOTICE: ALWAYS set engineering channel 34 back to “0” once the error code is resolved.

Table 13

Display	Unit Status	Malfunction Description	Corrective action
EH0B	Unit Lockout	Controller to PCB communication error (controller stops working/malfunction)	<ol style="list-style-type: none"> 1. Power cycle the unit. 2. Turn off electrical power at breaker. 3. Disconnect and reconnect controller cable to controller. 4. Disconnect and reconnect CN53 connector on the main PCB. 5. If the error persists, contact a qualified person to replace controller.
EH00	Unit Lockout	Machine working parameters are abnormal.	<ol style="list-style-type: none"> 1. Power cycle the unit. 2. If the error persists, contact a qualified person to replace main PCB.
EH03	Unit Lockout	Fan motor fault	<ol style="list-style-type: none"> 1. Turn off electrical power at breaker. 2. Disconnect and reconnect CN51 connector on the main PCB. 3. Inspect fan motor wire for damage. 4. If the error persists, contact a qualified person to replace fan motor.
PH15	Unit Lockout	Electric current leakage (If PCB current difference between L,N >14mA)	<ol style="list-style-type: none"> 1. Power cycle the unit. 2. Turn off electrical power at breaker. 3. Check all connections on the main PCB. 4. If the error persists, contact a qualified person to replace main PCB.
EC54	Unit Lockout	Compressor discharge temperature sensor (TP) failure.	<ol style="list-style-type: none"> 1. Turn off electrical power at breaker. 2. Disconnect and reconnect CN28 connector on the main PCB. 3. Inspect wire for damage. 4. If the error persists, contact a qualified person to replace temperature sensor.
EH5H	If both T3 and TH fail, ONLY heat pump stops	Compressor suction temperature sensor (TH) failure.	<ol style="list-style-type: none"> 1. Turn off electrical power at breaker. 2. Disconnect and reconnect CN29 connector on the main PCB. 3. Inspect wire for damage. 4. If the error persists, contact a qualified person to replace temperature sensor.

ECS3	If both T4 and T3 fail, ONLY heat pump stops	Ambient temperature sensor (T4) failure.	<ol style="list-style-type: none"> 1. Turn off electrical power at breaker. 2. Disconnect and reconnect CN28 connector on the main PCB. 3. Inspect wire for damage. 4. If the error persists, contact a qualified person to replace HP temperature sensor
ECS2	If both T4 and T3 fail, ONLY heat pump stops	Evaporator temperature sensor (T3) failure.	<ol style="list-style-type: none"> 1. Turn off electrical power at breaker. 2. Disconnect and reconnect CN28 connector on the main PCB. 3. Inspect wire for damage. 4. If the error persists, contact a qualified person to replace HP temperature sensor
EHSL	If both T4 and T3 fail, Unit lockout	Lower tank water temperature sensor (T5L) failure.	<ol style="list-style-type: none"> 1. Turn off electrical power at breaker. 2. Disconnect and reconnect CN24 connector on the main PCB. 3. Inspect wire for damage. 4. If the error persists, contact a qualified person to replace water temperature sensor
EHSU	If both T4 and T3 fail, Unit lockout	Upper tank water temperature sensor (T5U) failure.	<ol style="list-style-type: none"> 1. Turn off electrical power at breaker. 2. Disconnect and reconnect CN24 connector on the main PCB. 3. Inspect wire for damage. 4. If the error persists, contact a qualified person to replace water temperature sensor
EHSD	ONLY E-Heater Stops	Electric heater open-circuit error	<ol style="list-style-type: none"> 1. Turn off electrical power at the breaker. 2. Check if TCO switch is triggered. If triggered, follow section 9.4 to reset it. 3. Check wires at elements, thermostat and control assembly board for damage. 4. If the error persists, contact a qualified person.
EHP	ONLY Heat Pump Stops	Heat pump system fault. (When PH20, PH21, PC30, PC06 any protection appears 3 times or the protection lasts more than 1 hour)	Call our Technical Support Team on a toll free number which is listed in section 9.6, "How to Obtain Service".
PHDH	Unit Lockout	Dry Fire protection.	<ol style="list-style-type: none"> 1. Turn off electrical power at breaker. 2. Check if tank is fully filled with water. If not, add water by opening a hot water faucet to bleed all air until water flows without air bursts. 3. Turn on electrical power at breaker.
PH20	ONLY Heat Pump Stops	Compressor discharge temperature protection (too low)	Call our Technical Support Team on a toll free number which is listed in section 9.6, "How to Obtain Service".
PH21	ONLY Heat Pump Stops	Compressor working current protection (too high)	<ol style="list-style-type: none"> 1. Power cycle the unit to see if code clears. 2. Turn off electrical power at breaker. 3. Inspect wire for damage. 4. If the error persists, contact a qualified person to replace temperature sensor.

PH24	Shut-off valve closes	Freeze protection (When T5L < 39°F (4°C) and T4 < 45°F (7°C))	<ol style="list-style-type: none"> 1. Power cycle the unit to see if code clears. 2. If error persists, call our Technical Assistance Hotline which is listed on the water heater's warranty sheet for further assistance.
PC30	ONLY Heat Pump Stops	System high pressure protection (protection active when $\geq 3.0\text{MPa}$ active and inactive when $\leq 2.4\text{Mpa}$)	<ol style="list-style-type: none"> 1. Check if the air filter or air outlet is blocked. If blocked, clean and see if the error code clears. 2. Check if evaporator is covered with too much dust. 3. If the error persists, contact a qualified person to service the unit.
PC06	ONLY Heat Pump Stops	High TP protection. (protection active when TP > 221°F (105°C) and inactive when TP < 194°F (90°C)).	<ol style="list-style-type: none"> 1. Turn off electrical power at breaker. 2. Disconnect and reconnect CN28 connector on the main PCB. 3. Inspect wire for damage. 4. If the error persists, contact a qualified person to service the unit.
PH9B	Unit Lockout	Overtemperature protection. (When the water temperature exceeds the set temperature by more than 9°F (5°C)).	<ol style="list-style-type: none"> 1. Turn off electrical power at breaker. 2. Disconnect and reconnect CN24 connector on the main PCB. 3. Inspect wire for damage. 4. If the error persists, contact a qualified person to service the unit.
PH9I	ONLY Heat Pump Stops	Low T3 protection.	<ol style="list-style-type: none"> 1. Turn off electrical power at breaker. 2. Disconnect and reconnect CN28 connector on the main PCB. 3. Inspect wire for damage. 4. If the error persists, contact a qualified person to service the unit.
PH22	Shut-off valve closes	Tank leakage protection	<ol style="list-style-type: none"> 1. Turn off electrical power at the breaker, check all electrical connections, and wiring for damage. 2. Check for plumbing leaks and correct accordingly. 3. If tank is leaking, call our Technical Support Team on toll free number which is listed on the water heater's warranty sheet for further assistance.
PHLI	ONLY Heat Pump Stops	Condensate drain leakage protection	<ol style="list-style-type: none"> 1. Check if the condensate line is clogged. If clogged, follow instructions of section 7.5 to clean it. 2. Check if the water level switch located near compressor works. 3. Disconnect and reconnect CN10 connector on the main PCB. 4. If error persists, contact a qualified person service the unit.
FC06	Shut-off Valve closes	Shut-off valve malfunction	<ol style="list-style-type: none"> 1. Check if the shut-off valve connector is connected. 2. Ensure that the shut-off valve motor assembly is properly secured to valve. 3. If it does not work properly, contact a qualified person.

9. Customer Service

9.1 CTA Module Set-Up

As shown in *Figure 28*, CTA module connection port is located on top right side of water heater. To gain access of the port, remove 3 screws holding junction box cover and connect the module to the port.

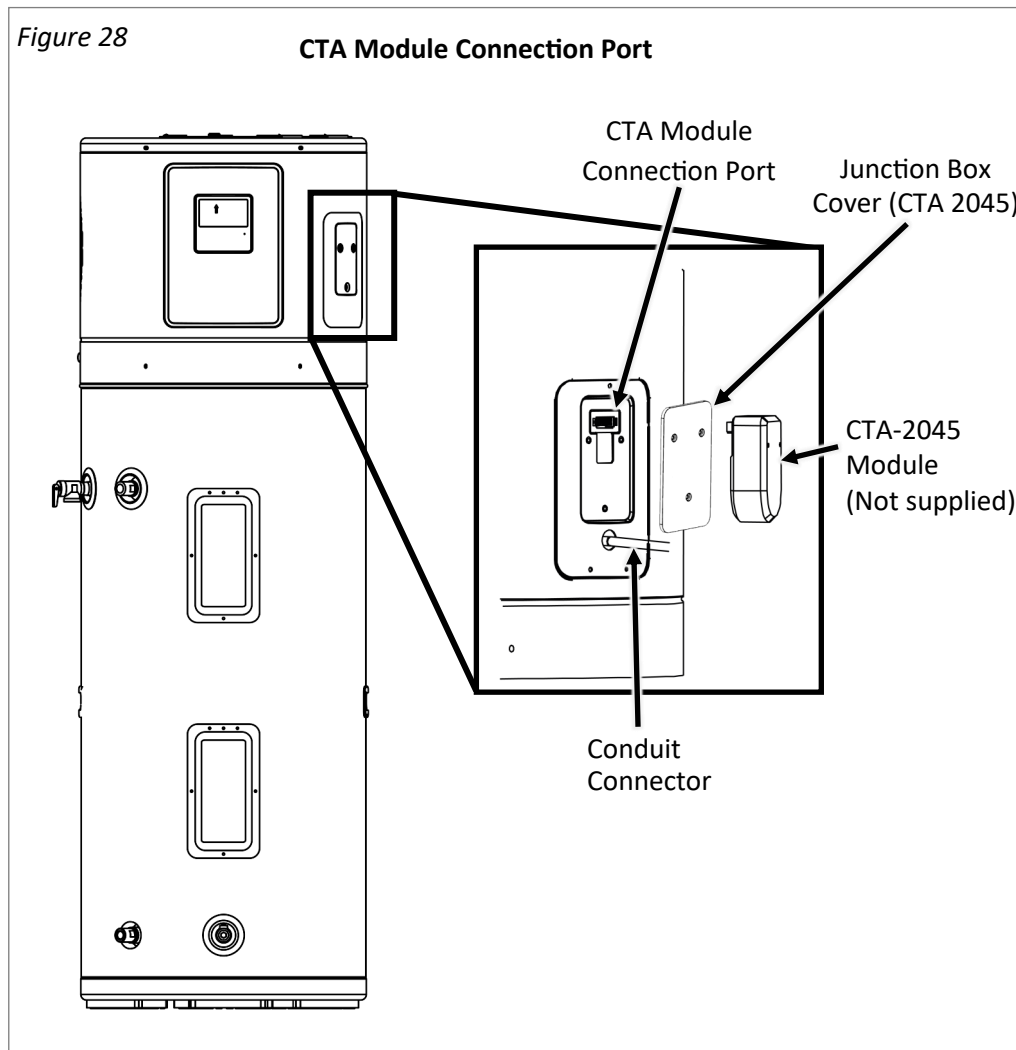

NOTICE

A CTA2045 compliant Module can be connected to the water heater's connection port. Follow the instructions from the CTA2045 Module supplier for initial startup.

9.2 Demand Response (CTA-2045) Installations

NOTICE

In demand response applications, a thermostatic mixing valve in compliance with ASSE 1017 must be placed on the hot water supply line, following all installation instructions provided by the manufacturer.

Figure 28

Nominal 3/4" size mixing or tempering valve (refer to warning above). Follow mixing or tempering valve manufacturer's instructions for installation of the valve

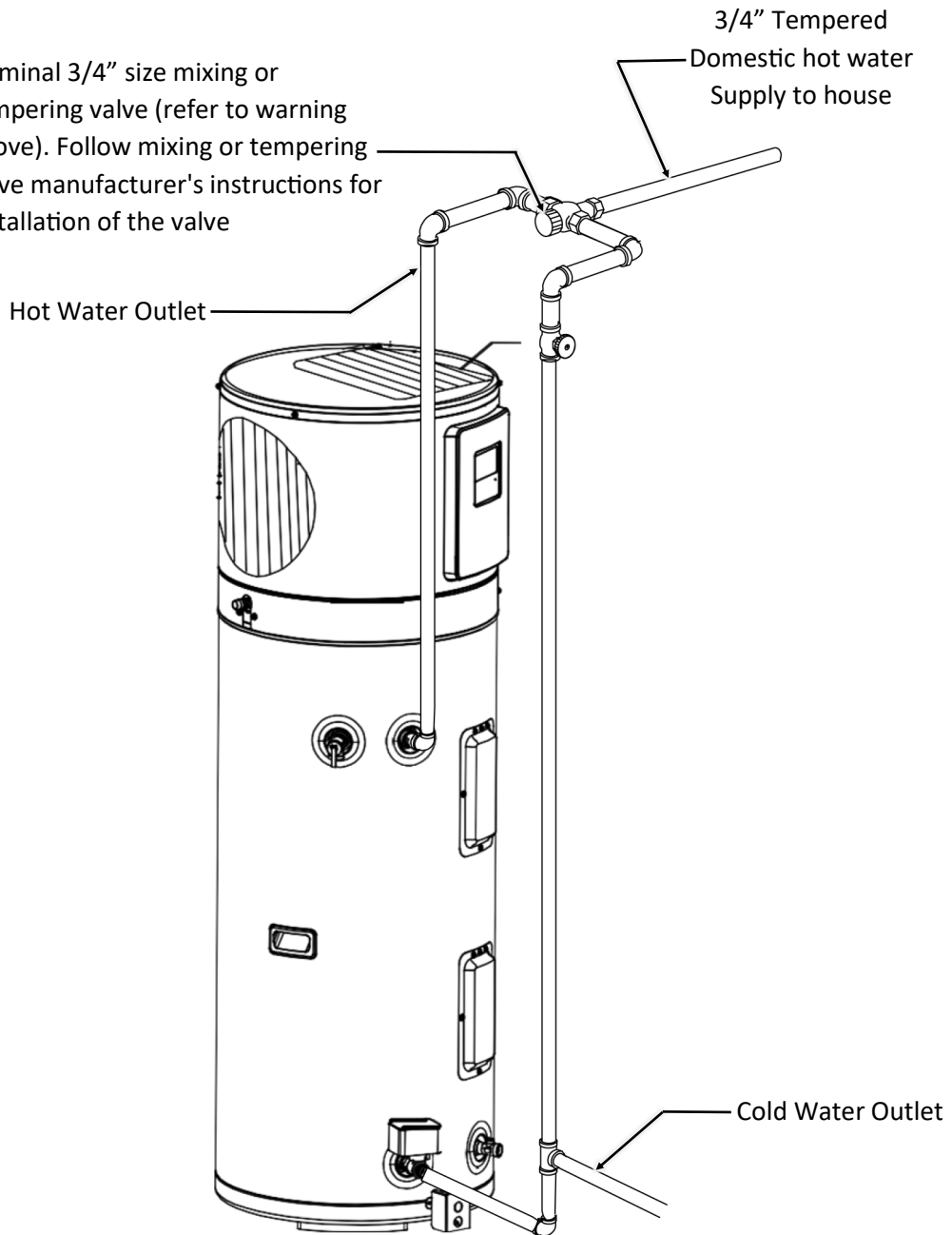

9.3 Replacement Parts

9.3.1 Instruction For Placing a Parts Order

Address parts orders to the distributor or store where the heater was purchased. All parts orders should include:

- 1) The model and serial number of the water heater from the rating plate located on the tank jacket.
- 2) Specify voltage and wattage as marked on the rating plate.
- 3) Part description (as noted below) and number of parts desired.

NOTICE

Check the water heater's rating label on the front of the unit for the acceptable element wattage.

CAUTION

For your safety DO NOT attempt repair of electrical wiring, heating elements, heat pump or electronic controls. Refer repairs to qualified service personnel

WARNING

FLAMMABLE CONTENTS UNDER PRESSURE. The compressor is not a serviceable part. The compressor wiring terminals may be allowing pressurized refrigerant and oil to escape, ignite and cause serious bodily injury, severe burns or death.

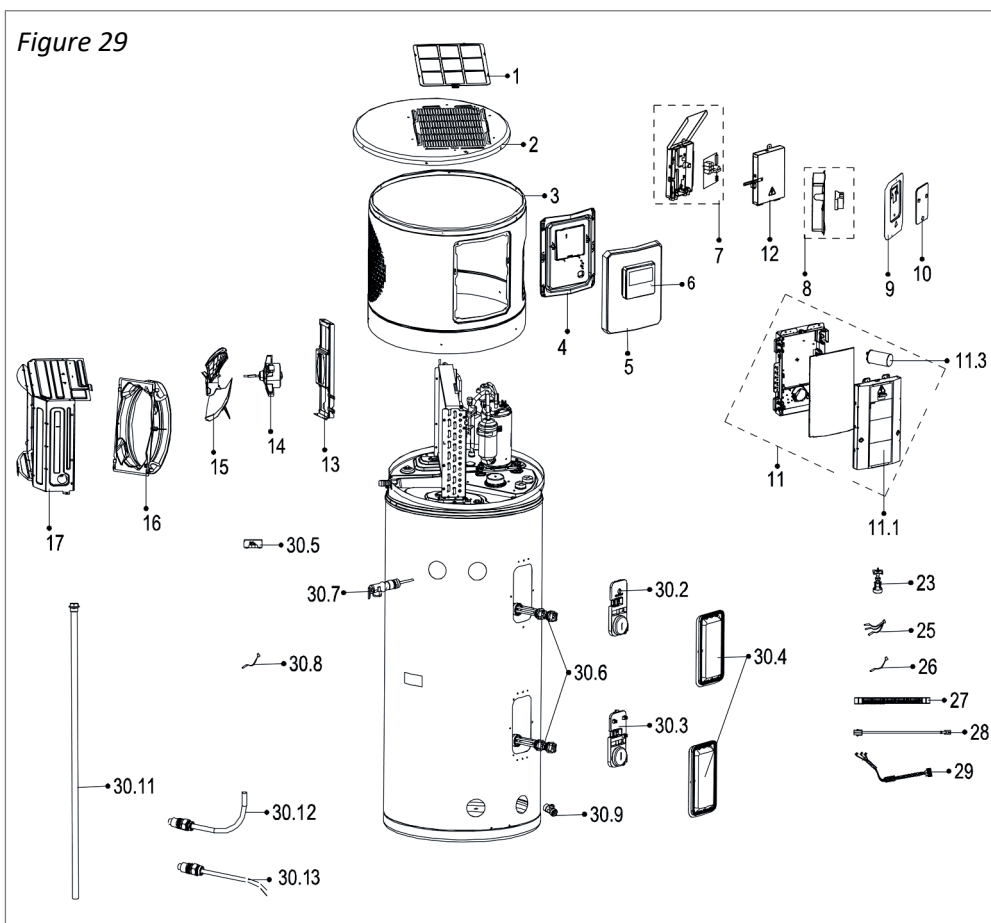

Table 14

Item	Description	Part Number		Qty
		50 Gallon	80 Gallon	
1	Air Filter	108000136		1
2	Top Cover	109001486	109001489	1
3	Front Cover	109001485	109001488	1
4	Display Box Rear Cover	109001483		1
5	Display Box Front Cover	109001478		1
6	Display Box Assembly	105002062		1
7	Relay Board E-Box Assembly	105002060		1
8	Junction Box Subassembly	105002061		1
9	Junction Box Cover	109001477		1
10	Junction Box Cover (CTA-2045)	109001479		1
11	Main Control E-Box Assembly	105002065	105002068	1
11.1	Main Control E-Box Lid Assembly	109001480		1
11.3	Compressor Capacitor	105002063		1
12	Cover of Relay Board E-Box	109001482		1
13	Motor Holder Assembly	109001481		1
14	Fan Motor	108000140		1
15	Axial Flow Fan	108000137		1
16	Ventilation Ring	108000141		1
17	Fan Box Assembly	108000138	108000139	1
23	Water Level Switch	105002058		1
25	HP Temperature Sensors (T3, T4, TP)	105002066	105002067	1
26	Suction Line Temperature Sensor (TH)	105002059		1
27	Drainage Pipe	107000674		1
28	Ground Wire	105002055		1
29	Compressor Harness	105002056		1
30.2	Insulating Cover (Upper)	109001492		1
30.3	Insulation Cover (lower)	109001493		1
30.4	Cover (TCO)/Cover (Electric Heater)	109001491		2
30.5	Thermal Cut-off (TCO)	105002070		1
30.6	Element Heater	105002064		1
30.7	T&P Valve	107000677		1
30.8	Water Temperature Sensor	105002069		2
30.9	Drain Valve	107000678		1
30.11	Anode Rod	107000679	107000680	1
30.12	Water Outlet J-Tube	107000675		1
30.13	Water Inlet Pipe Assembly	107000676		1

9.4 Thermal Cut-off Reset Instructions

CAUTION

The following instructions are intended for qualified service personnel ONLY and should only be done when necessary.

Figure 30

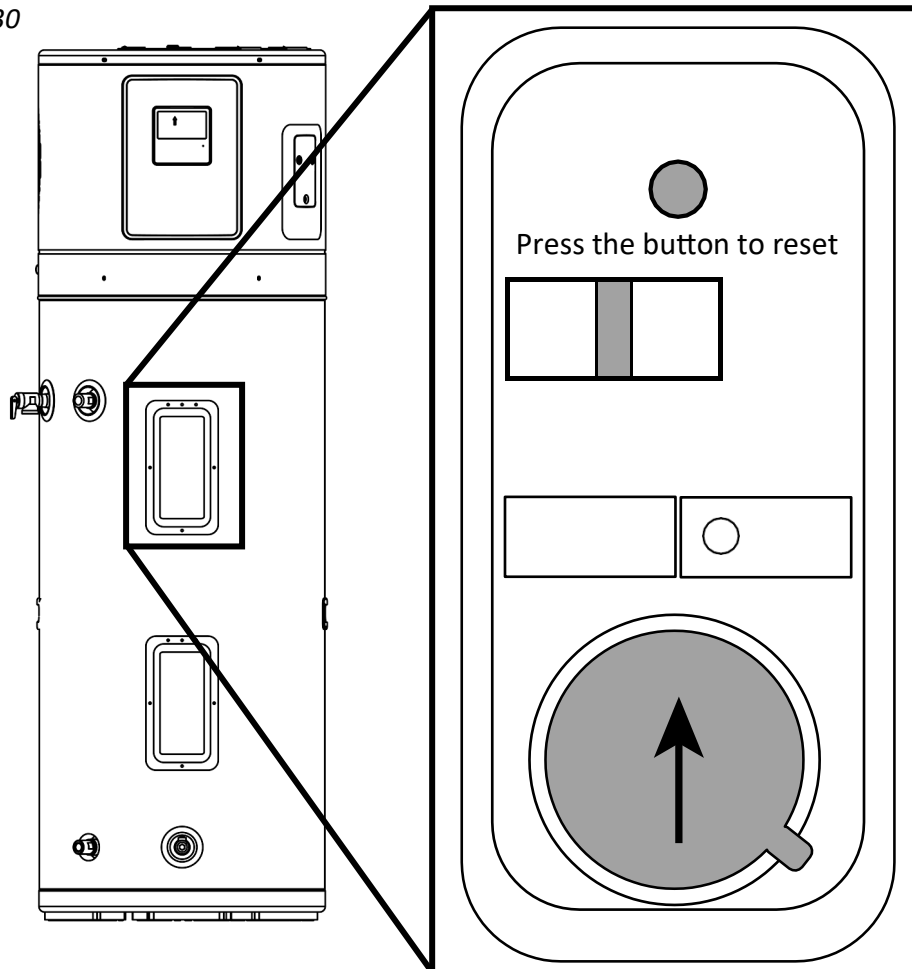

WARNING

Before working near an energized circuit, ensure that all power to the unit is disconnected. Neglecting to do so may lead to electrical shock, causing significant personal injury or even death.

In order to reset the thermal cut-off (TCO) or replace water temperature sensors and/or a heating element, follow the instructions below:

1. Turn off electrical power at breaker.
2. Remove six screws holding the TCO cover and disassemble it.
3. Remove one screw holding insulating cover to gain access to TCO/ water temperature sensor/heating element.
4. Reset the TCO by pressing the button (refer *Figure 30*) or replace thermistor and/or element as necessary.
5. Remount the insulation cover, TCO cover, and turn on the electrical power at breaker.

9.5 Wiring Diagram

Figure 31

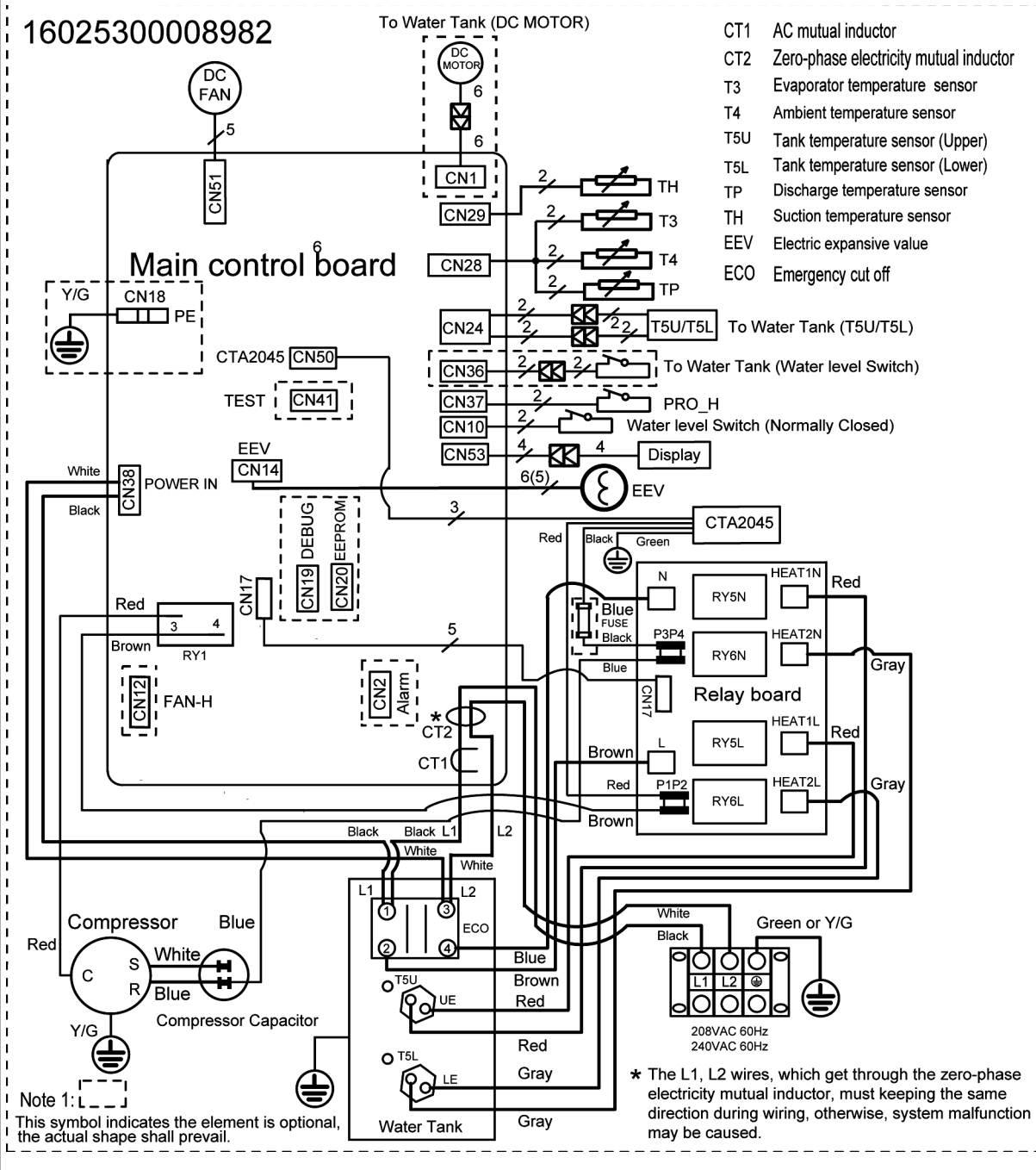

9.6 Warranty

What Is Covered?

The Rinnai Standard Limited Warranty covers any defects in materials or workmanship when the product is installed and operated according to Rinnai published product specifications, subject to the terms within this Limited Warranty document. This Limited Warranty applies only to products that meet the requirements of a “qualified product installation” and are originally installed in the United States and Canada. Improper installation may void this Limited Warranty. A “qualified product installation” consists of the following: (1) installed by a company or individual which holds a current government issued license which certifies the company or individual is qualified to install and service Electric Heat Pump Water Heater in the state where the product is located, if such licensing is required; and (2) installation, startup, operation and service is performed in compliance with (a) all Rinnai published engineering, application, installation, startup and service documentation, (b) all applicable federal, state and local laws, (c) applicable plumbing, electrical, mechanical and building codes and best industry standards. This Limited Warranty is subject to the conditions that the Rinnai electric heat pump water heater has been installed per the “qualified product installation” terms and ongoing and proper maintenance has been performed, according to Rinnai Installation and Service documentation, by a professional, licensed (if required) contractor. Proof of the required service and maintenance tasks being completed must be kept in the provided Rinnai Installation and Service Record. This Limited Warranty coverage, as set out in the table below, extends to the original end use purchaser and subsequent owners, but only while the product remains at the site of the original installation, and terminates if the product is moved or reinstalled at a new location.

Table 15

Item	Period of Coverage (from date of purchase)
Tank	10 Years
All Other Parts and Components ^[1]	10 Year
Reasonable Labor	1 Year

^[1] Parts replaced during recommended maintenance procedures are not covered by this Limited Warranty.

What Will Rinnai Do?

Rinnai will repair or replace the covered product or any part or component that is defective in materials or workmanship as set forth in the above table for products which meet the “qualified product installation” requirements. Rinnai will pay reasonable labor charges associated with the repair or replacement of any such part or component during the term of the labor warranty period. All repair parts must be genuine Rinnai parts. All repairs or replacements must be performed by a qualified professional who is properly trained to do the type of repair.

Replacement of the product may only be authorized by Rinnai at its sole discretion. Rinnai does not authorize any person or company to assume for it any obligation or liability in connection with the replacement of the product. If Rinnai determines that repair of a product is not possible, Rinnai may replace the product with a comparable product at Rinnai’s sole discretion. The warranty claim for product parts and labor may be denied if a component or product returned to Rinnai is found to be free of defects in material or workmanship; damaged by improper installation, use or operation; or damaged during return shipping.

How To Obtain Service: For the name of a trained and qualified professional, please contact your place of purchase, visit the Rinnai website (www.rinnai.us), call Rinnai at 1-800-621-9419 or write to Rinnai at 103 International Drive, Peachtree City, Georgia 30269.

Proof of purchase is required to obtain warranty service. You may show proof of purchase with a dated sales receipt, or by registering within 90 days of purchasing the product. To register your Rinnai Heat Pump Water Heater, please visit www.rinnai.us. For those without internet access, please call 1-800-621-9419. Receipt of registration by Rinnai will constitute proof-of-purchase for this product. Registration of product installed in new home construction may be verified with a copy of the closing papers provided by the initial home buyer. However, registration is not necessary in order to validate this Limited Warranty.

What is Not Covered? This Limited Warranty does not cover any failures, or operating difficulties due to the following:

- Accident, abuse, misuse, alteration or misapplication
- Force majeure
- Improper installation (such as but not limited to inadequate water quality, condensate damage, improper ducting, incorrect water pressure, or absence of a drain pan under the product)
- Damage caused by incorrect commissioning
- Improper maintenance (such as but not limited to scale build-up, freeze damage, or duct blockage)
- Use in or around areas where chemical agents are used (such as but not limited to chlorine, hair spray, or hair dyes)
- Damage or failure caused by contaminated air, including, but not limited to sheetrock particles, plasterboard particles, dust, dirt, or lint entering the water heater or any of its components
- Water hammer
- Any other causes other than defects in materials or workmanship

This Limited Warranty does not cover any other costs including but not limited to lodging, fuel, transportation, handling, etc. incurred during in the installation, removal, replacement, repair, maintenance, troubleshooting or complying with National, State or Local building, mechanical or electrical codes nor any expenses associated with providing substitute or temporary equipment and/or service during time in which product is inoperable or not being utilized pending repair or replacement under this Limited Warranty.

If you purchase a Rinnai product from an unauthorized dealer, or if the original factory serial number has been removed, defaced or altered, your Rinnai warranty will not be valid.

Limitation on Warranties: No one is authorized to make any other warranties on behalf of Rinnai America Corporation. Except as expressly provided herein, there are no other warranties, expressed or implied, including, but not limited to warranties of merchantability or fitness for a particular purpose, which extend beyond the description of the warranty herein.

This Limited Warranty shall not be affected, extended, or enlarged and no additional obligation or liability will be incurred by Rinnai providing technical information, applications recommendations, or equipment modifications to any entity or person who is related to the design, equipment selection, installation, operation, maintenance, service, or repair of the product.

Any implied warranties of merchantability and fitness arising under state law are limited in duration to the period of coverage provided by this Limited Warranty, unless the period provided by state law is less. Some states do not allow limitations on how long an implied Limited Warranty lasts, so the above limitation may not apply to you.

Rinnai shall not be liable for indirect, incidental, special, consequential, or other similar damages that may arise, including lost profits, damage to person or property, loss of use, inconvenience, or liability arising from improper installation, service, or use. Some states do not allow the exclusion or limitation of incidental or consequential damages, so the above limitation may not apply to you.

This Limited Warranty gives you specific legal rights, and you may also have other rights which vary from state to state.

Rinnai America Corporation

103 International Drive
Peachtree City, GA 30269
Tel. 1-800-621-9419
Web. www.rinnai.us
www.rinnai.ca

100000867(01)
4/2024